

Data sheet | Item number: 770-242

Socket; 2-pole; Cod. B; 4,00 mm²; gray

www.wago.com/770-242

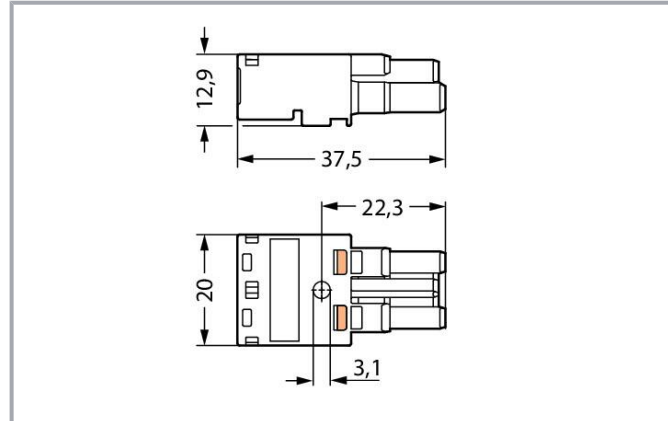
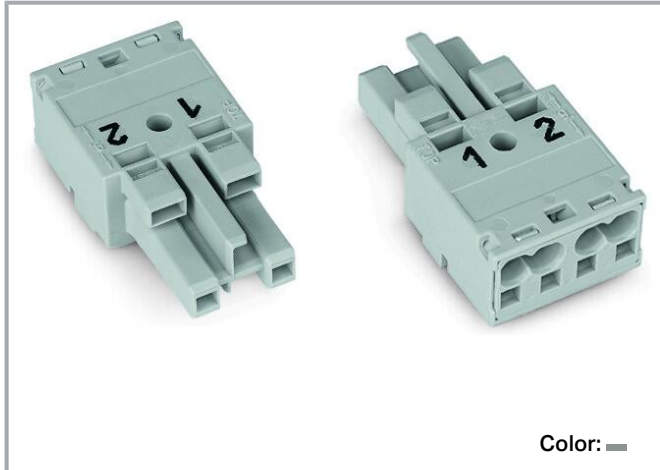

Item description

Female connector/socket *WINSTA*® MIDI rated current 25 A

For power and signal transmission: The *WINSTA*® MIDI female connector/socket with protection type IP20. WAGO pluggable installation connectors can be used when specifications repeat or are planned on a defined pattern, for example for installing grid lighting or flush-mount lighting. The mechanical coding and color coding of the pluggable installation connector ensure error-free installation of the individual components – including protection against mismatching. The pluggable installation connector is protected in accordance with protection type IP20 (When mated and secured with a strain relief housing: IP2xC (These compact connectors are not designed for use in open, easily accessible areas!)). That results in the fact that users' fingers will never come into contact with electrified elements. Pluggable installation connectors with B coding from the *WINSTA*® MIDI line are available in gray, light green, or pink, allowing you to distinguish different circuits, for example for pumps, lighting, or sun blinds. Customer-specific pole marking is possible, too. This pluggable installation connector can be used for electrical currents up to 25 A. Thus the product is also suitable for high power loads. The *WINSTA*® MIDI product line offers maximum flexibility for the installation. With its Push-in CAGE CLAMP® spring pressure connection technology, it guarantees time-saving, error-free installation and offers customization and flexibility for meeting an enormous variety of installation requirements.

WINSTA® MIDI solutions for your electrical installation – protected against mismatching and maintenance-free

The *WINSTA*® Pluggable Connection System allows pluggable electrical installation. This saves time, lowers costs, and reduces the need for servicing. Enjoy the benefits of the pluggable version of our maintenance-free spring pressure connection technology too! Plan your installation

Subject to changes. Please also observe the further product documentation!

WAGO GmbH & Co. KG
Hansastr. 27
32423 Minden
Phone: +49571 887-0 | Fax: +49571 887-169
Email: info.de@wago.com | Web: www.wago.com

Do you have any questions about our products?
We are always happy to take your call at +49 (571) 887-44222.



with with protection type IP20 from WAGO.

-
- pluggable installation connectors with protection against mismatching
- pre-assembled versions
- for automation controllers
- flexible installation to save space
- rapid, structured electrical installation

Data

Notes

Variants:

Other pole markings

Other versions (or variants) can be requested from WAGO Sales or configured at <https://configurator.wago.com/>.

Electrical data

Ratings per IEC/EN

Ratings per	IEC/EN 60664-1
Nominal voltage (III/3)	250 V
Rated impulse voltage (III/3)	4 kV
Rated current	25 A
Legend (ratings)	(III / 3) ≙ Overvoltage category III / Pollution degree 3

Ratings per UL 1977

Note for the US market

Some versions may also be used for current interruption in accordance with the UL certificate in select applications with currents below 16 A and voltages up to 600 V. For further information, please contact your local sales office.

Rated voltage (UL 1977)	600 V
Rated current UL 1977	23 A

General information

Note on contact resistance

approx. 1 mΩ of contact resistance
approx. 0.25 mΩ contact transition plug/socket

Subject to changes. Please also observe the further product documentation!

WAGO GmbH & Co. KG

Hansastr. 27

32423 Minden

Phone: +49571 887-0 | Fax: +49571 887-169

Email: info.de@wago.com | Web: www.wago.com

Do you have any questions about our products?

We are always happy to take your call at +49 (571) 887-44222.



Connection data

Connection points	4
Total number of potentials	2

Connection 1

Connection technology	Push-in CAGE CLAMP®
Actuation type	Operating tool Push-in
Nominal cross-section	4 mm ² / 12 AWG
Solid conductor	0.5 ... 4 mm ² / 20 ... 12 AWG
Solid conductor; push-in termination	1.5 ... 4 mm ² / 16 ... 12 AWG
Stranded conductor	0.5 ... 2.5 mm ² / 20 ... 14 AWG
Fine-stranded conductor	0.5 ... 4 mm ² / 20 ... 12 AWG
Fine-stranded conductor; with insulated ferrule	0.25 ... 1.5 mm ² / 20 ... 16 AWG
Fine-stranded conductor; with uninsulated ferrule	0.25 ... 2.5 mm ² / 20 ... 14 AWG
Fine-stranded conductor; with ferrule; push-in termination	1.5 mm ² / 16 AWG
Strip length	9 mm / 0.35 inches
Pole number	2
Conductor entry direction to mating direction	0°

Physical data

Pin spacing	10 mm / 0.394 inches
Width	20 mm / 0.787 inches
Height	12.9 mm / 0.508 inches
Depth	37.5 mm / 1.476 inches

Mechanical Data

Application	Control technology
Coding	B
Variable coding	No
Marking	1 2
Potential marking	1 2
Mating force of a plug-in connection	approx. 20 ... 70 N (depending on pole number)
Retention force of a plug-in connection	Locked: > 80 N
Unmating force of a plug-in connection	Unlocked: approx. 20 ... 70 N (depending on pole number)

Subject to changes. Please also observe the further product documentation!



Number of mating cycles	200, without resistive load
Protection type	IP20; When mated and secured with a strain relief housing: IP2xC (These compact connectors are not designed for use in open, easily accessible areas!)

Plug-in connection

Contact type (pluggable connector)	Female connector/socket
Connector (connection type)	for conductor
Mismating protection	Yes
Note on mismating protection	All <i>WINSTA</i> [®] components are 100% protected against mismating when: a.) plugging different numbers of poles b.) plugging while rotated 180 c.) plugging while laterally staggered d.) plugging one pole
Locking lever	Can be retrofitted
Locking of plug-in connection	locking lever
Note on locking system	All connectors for mounted installations (snap-in versions for lighting fixtures or devices, all types of PCB and distribution connectors) are factory-equipped with locking levers to ensure plugs and sockets are securely locked. Additional locking levers are only required for flying leads (plug/socket).

Material data

Note (material data)	Information on material specifications can be found here
Color	gray
Cover color	gray
Material group	I
Insulation material	Polyamide (PA66)
Flammability class per UL94	V0
Clamping spring material	Chrome-nickel spring steel (CrNi)
Contact material	Copper or copper alloy; surface-treated
Contact plating	Tin
Fire load	0.127 MJ
Weight	6.6 g

Subject to changes. Please also observe the further product documentation!

WAGO GmbH & Co. KG
Hansastr. 27
32423 Minden
Phone: +49571 887-0 | Fax: +49571 887-169
Email: info.de@wago.com | Web: www.wago.com

Do you have any questions about our products?
We are always happy to take your call at +49 (571) 887-44222.

Environmental requirements

Processing temperature	-5 ... +40 °C
Continuous operating temperature	-35 ... +85 °C
Note on continuous operating temperature	Insulating parts for temperatures ≤ 105 °C

Commercial data



Product Group	20 (Winsta)
eCl@ss 10.0	27-44-06-05
eCl@ss 9.0	27-44-06-05
ETIM 8.0	EC002560
ETIM 7.0	EC002560
ECCN	NO DATA
PU (SPU)	100 pcs
Packaging type	box
Country of origin	DE
GTIN	4050821541912
Customs tariff number	85366990990

Environmental Product Compliance

RoHS Compliance Status	Compliant, No Exemption
------------------------	-------------------------

Approvals / Certificates



General approvals

Logo	Approval	Additional Approval Text	Certificate name
	CCA DEKRA Certification B.V.	IEC 61984	NL-32104
	CCA DEKRA Certification B.V.	EN 61984	2173495.01
	cURus Underwriters Laboratories Inc.	UL 1977	E45171
	cURus Underwriters Laboratories Inc.	UL 1059	E 45172



Subject to changes. Please also observe the further product documentation!







Declarations of conformity and manufacturer's declarations

Logo	Approval	Additional Approval Text	Certificate name
	EU-Declaration of Conformity WAGO GmbH & Co. KG	-	-
	UK-Declaration of Conformity WAGO GmbH & Co. KG	-	-

Approvals for marine applications

Logo	Approval	Additional Approval Text	Certificate name
	ABS American Bureau of Shipping	-	19- HG1868589- PDA
	DNV GL Det Norske Veritas, Germanischer Lloyd	-	TAE00001Z6
	LR Lloyds Register	IEC 61984	LR22429487TA

Counterpart

	Item no.770-1601 T-distribution connector; 2-pole; Cod. B; 1 input; 2 outputs; 2 locking levers; gray	www.wago.com/770-1601
	Item no.770-1608 h-distribution connector; 2-pole; Cod. B; 1 input; 2 outputs; outputs on both sides; 2 locking levers; gray	www.wago.com/770-1608
	Item no.770-1651 h-distribution connector; 2-pole; Cod. B; 1 input; 2 outputs; outputs on one side; 2 locking levers; gray	www.wago.com/770-1651
	Item no.770-1658	

Subject to changes. Please also observe the further product documentation!

WAGO GmbH & Co. KG
Hansastr. 27
32423 Minden
Phone: +49571 887-0 | Fax: +49571 887-169
Email: info.de@wago.com | Web: www.wago.com

Do you have any questions about our products?
We are always happy to take your call at +49 (571) 887-44222.

h-distribution connector; 2-pole; Cod. B; 1 input; 2 outputs; outputs on both sides; 3 locking levers; for flying leads; gray www.wago.com/770-1658



Item no. 770-1701
T-distribution connector; 2-pole; Cod. B; 1 input; 2 outputs; 3 locking levers; for flying leads; gray www.wago.com/770-1701



Item no. 770-1704
3-way distribution connector; 2-pole; Cod. B; 1 input; 3 outputs; gray www.wago.com/770-1704



Item no. 770-1751
h-distribution connector; 2-pole; Cod. B; 1 input; 2 outputs; outputs on one side; 3 locking levers; for flying leads; gray www.wago.com/770-1751



Item no. 770-252
Plug; 2-pole; Cod. B; 4,00 mm²; gray www.wago.com/770-252



Item no. 771-8992/005-103
pre-assembled interconnecting cable; Eca; Socket/plug; 2-pole; Cod. B; Control cable 2 x 1.0 mm²; 1 m; 1,00 mm²; gray www.wago.com/771-8992/005-103



Item no. 771-8992/205-103
pre-assembled connecting cable; Eca; Plug/open-ended; 2-pole; Cod. B; Control cable 2 x 1.0 mm²; 1 m; 1,00 mm²; gray www.wago.com/771-8992/205-103

Required accessories

Locking levers

Locking system



Item no.: 770-121
Locking lever; for flying leads; for manual operation; white www.wago.com/770-121



Item no.: 770-131
Locking lever; for flying leads; for tool operation; white www.wago.com/770-131



Item no.: 770-101
Locking lever; for flying leads; for manual operation; black www.wago.com/770-101



Item no.: 770-111
Locking lever; for flying leads; for tool operation; black www.wago.com/770-111

Strain relief

Strain relief housing



Item no.: 770-502/041-000
Strain relief housing; 2-pole; with locking clip; for 1 cable; 7.0 ... 10.5 mm; 35 mm; black www.wago.com/770-502/041-000



Item no.: 770-502/042-000
Strain relief housing; 2-pole; with locking clip; for 1 cable; 5.0 ... 9.0 mm; 35 mm; black www.wago.com/770-502/042-000

Subject to changes. Please also observe the further product documentation!



Item no.: 770-512/041-000

Strain relief housing; 2-pole; with locking clip; for 1 cable; 7.0 ... 10.5 mm; 35 mm; white

www.wago.com/770-512/041-000



Item no.: 770-512/042-000

Strain relief housing; 2-pole; with locking clip; for 1 cable; 5.0 ... 9.0 mm; 35 mm; white

www.wago.com/770-512/042-000

Optional accessories

Tool

Operating tool



Item no.: 210-719

Operating tool; Blade: 2.5 x 0.4 mm; with a partially insulated shaft

www.wago.com/210-719



Item no.: 770-382

Operating tool; 2-way; green

www.wago.com/770-382

Cover

Cover



Item no.: 770-201

Lockout cap; 12-pole, separable; for sockets; Plastic; black

www.wago.com/770-201



Item no.: 770-221

Lockout cap; 12-pole, separable; for sockets; Plastic; white

www.wago.com/770-221



Item no.: 897-2003

Protective cap; Type2; for sockets and plugs; PVC; red

www.wago.com/897-2003

Mounting

Mounting accessories



Item no.: 770-317

Snap-in frame; 2-pole; 1.0 ... 3.0 mm; black

www.wago.com/770-317



Item no.: 770-337

Snap-in frame; 2-pole; 1.0 ... 3.0 mm; white

www.wago.com/770-337



Item no.: 897-2100

Mounting plate; for Snap-in; Plastic; for detectors and sensors ; Ø 200 mm; red

www.wago.com/897-2100

Subject to changes. Please also observe the further product documentation!

WAGO GmbH & Co. KG

Hansastr. 27

32423 Minden

Phone: +49571 887-0 | Fax: +49571 887-169

Email: info.de@wago.com | Web: www.wago.com

Do you have any questions about our products?

We are always happy to take your call at +49 (571) 887-44222.



Downloads Documentation

Bid Text

770-242 X81 - Datei	2019 Feb 19	xml 3.0 kB	Download
770-242 doc - Datei	2015 Jun 8	doc 24.1 kB	Download

CAD/CAE-Data

CAD data

2D/3D Models 770-242		URL	Download
----------------------	--	-----	----------

CAE data

EPLAN Data Portal 770-242		URL	Download
WSCAD Universe 770-242		URL	Download
ZUKEN Portal 770-242		URL	Download

Asset Administration Shell

Asset Administration Shell 770-242		URL	Download
------------------------------------	--	-----	----------

Environmental Product Compliance

Compliance Search

Environmental Product Compliance 770-242 Socket; 2-pole; Cod. B; 4,00 mm ² ; gray		URL	Download
---	--	-----	----------

Installation Notes

Conductor termination

Subject to changes. Please also observe the further product documentation!

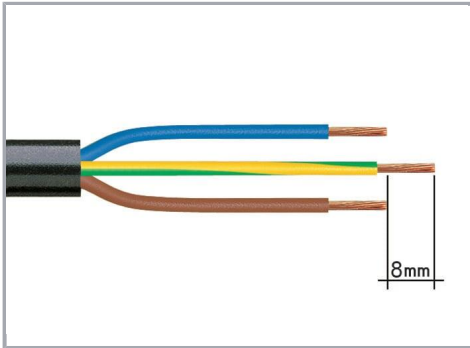

1. Strip length, outer insulation = 35 mm (2-pole), 55 mm (3- to 5-pole)
2. Strip length = 9 mm
3. Extended ground conductor = 8 mm

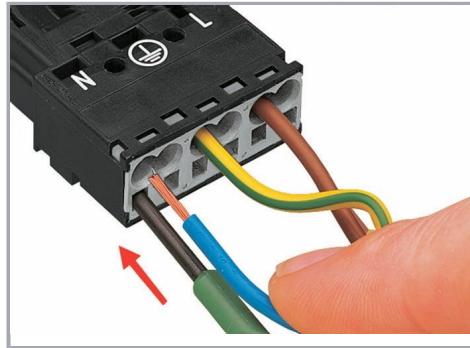

To terminate fine-stranded conductors, open the clamping unit via screwdriver (2.5 mm blade width) and insert a stripped conductor until it hits the backstop.

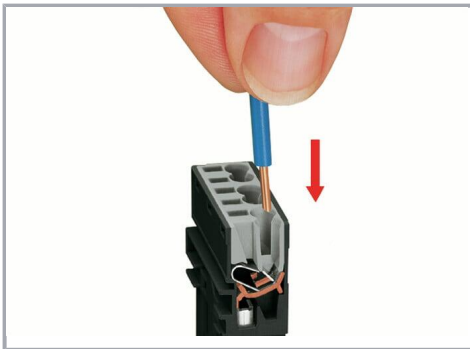

Insert the stripped solid conductor until it hits the backstop.

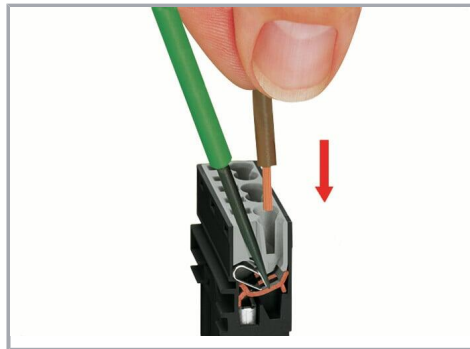

To terminate fine-stranded conductors, open the clamping unit via screwdriver (2.5 mm blade width) and insert a stripped conductor until it hits the backstop.

Conductor removal

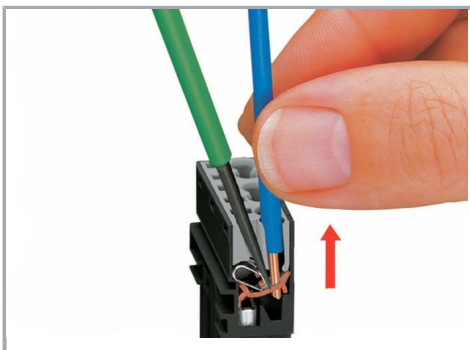

To remove the conductor, actuate the clamp via screwdriver (2.5 mm blade width) and pull out the conductor.

Subject to changes. Please also observe the further product documentation!

Installation

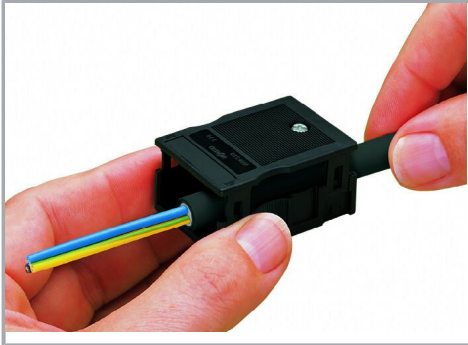

We recommend pulling the pre-latched strain relief housing over the cable prior to termination. However, the strain relief can be mounted at a later time as well.



Latch the strain relief housing onto the plug /socket. Note the "TOP" inscription.

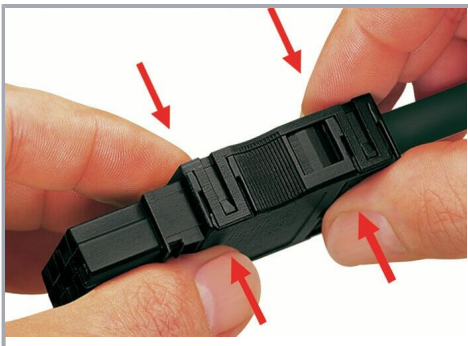

Prepare strain relief housing by snapping together upper and bottom part.



Tighten strain relief screw with screwdriver (2.5 mm blade width).

Coding



Simply cut off the coding pin from the socket.

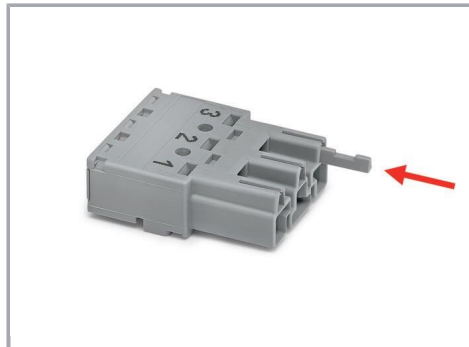

Insert coding pin into plug (break first) until it engages.

Mismatching protection

Subject to changes. Please also observe the further product documentation!

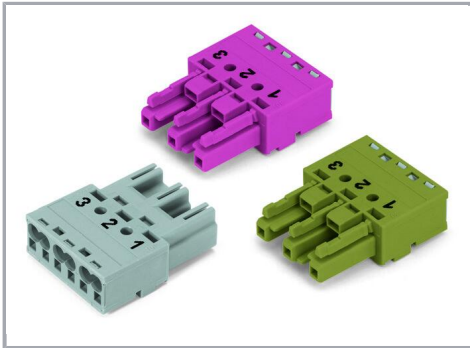

B-coded connectors with different colors can be plugged together.

Important note:

Different colors and/or pole markings are used for circuit identification.

Only connectors of the same color and same pole marking must be plugged together.

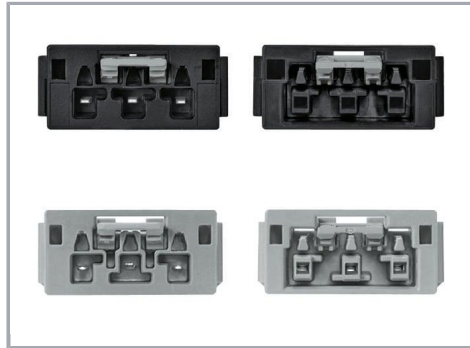

B-coded connectors (shown in gray) not only differ in color, but also in their design, making them incompatible with other coded connectors.



Easy circuit identification via different marking and colors

Product family

WINSTA® MIDI

[Show all products from the family](#)

Subject to changes. Please also observe the further product documentation!