

Data sheet | Item number: 770-804/011-000  
Socket for PCBs; angled; 4-pole; Cod. A; black

[www.wago.com/770-804/011-000](http://www.wago.com/770-804/011-000)

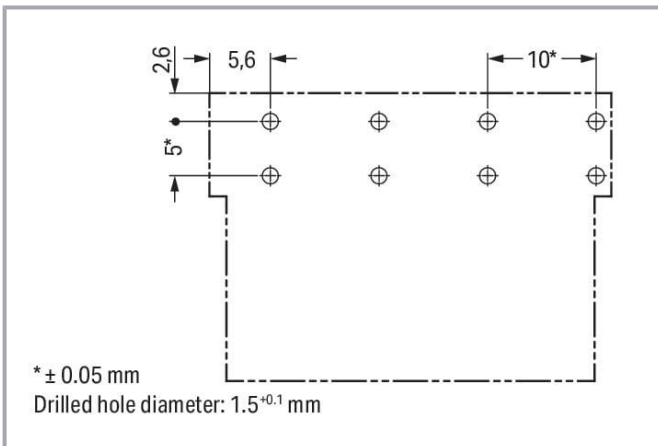
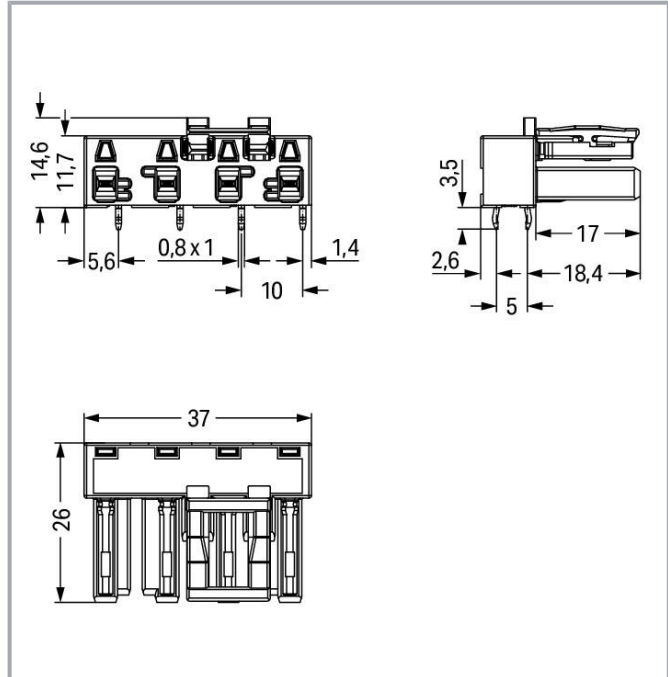
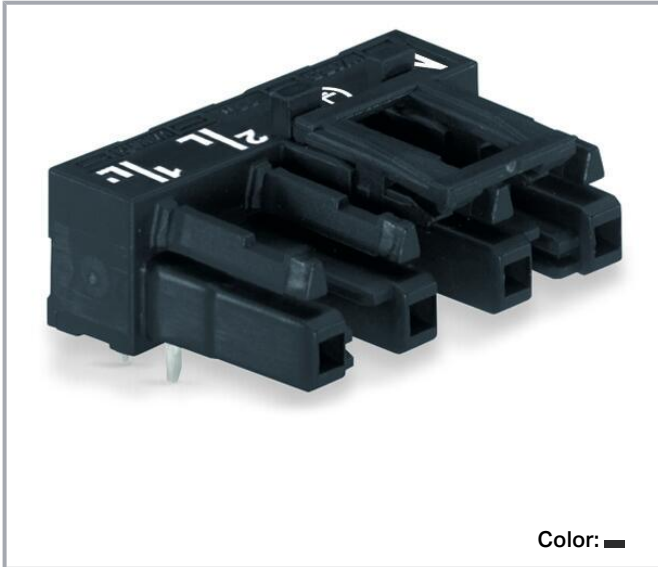

## Item description

Female connector/socket WINSTA® MIDI rated current 25 A

Subject to changes. Please also observe the further product documentation!

WAGO GmbH & Co. KG  
Hansastr. 27  
32423 Minden  
Phone: +49571 887-0 | Fax: +49571 887-169  
Email: [info.de@wago.com](mailto:info.de@wago.com) | Web: [www.wago.com](http://www.wago.com)

Do you have any questions about our products?  
We are always happy to take your call at +49 (571) 887-44222.



WAGO has various connection solutions for any challenge in building installation, for example, the *WINSTA*® MIDI female connector/socket. Our immense number of pluggable PCB connectors with various insertion directions and operating variants offers you the right solution for your application at any time. The coding options reduce installation errors, allowing fast, maintenance-free wiring of all components. Thanks to the color coding and mechanical A coding of *WINSTA*® MIDI pcb connectors, you can clearly distinguish different circuits. This pcb connectors is designed for a voltage load of up to 25 A. Thus, pcb connectors can also be used for high power loads. The *WINSTA*® MIDI Pluggable Connection System with Push-in CAGE CLAMP® spring pressure connection technology facilitates exemplary electrification. Thanks to the built-in test slot, connections can be checked even when they are plugged in. This saves time, labor, and money.

## **WINSTA® MIDI solutions for your electrical installation – protected against mismatching and maintenance-free**

The *WINSTA*® Pluggable Connection System allows pluggable electrical installation. This significantly reduces the need for servicing and lowers costs. Take advantage of the pluggable version of our maintenance-free spring pressure connection technology too! Plan your installation with with protection against mismatching from WAGO.

- protection against mismatching eliminates errors
- pre-assembled versions
- with A coding for use in many general mains applications
- convenient installation and commissioning

### **Data**

#### **Electrical data**

#### **Ratings per IEC/EN**

Ratings per	IEC/EN 60664-1
Nominal voltage (III/3)	400 V
Rated impulse voltage (III/3)	6 kV
Rated current	25 A
Legend (ratings)	(III / 3) ≙ Overvoltage category III / Pollution degree 3

#### **Ratings per UL 1977**

Note for the US market	Some versions may also be used for current interruption in accordance with the UL certificate in select applications with currents below 16 A and voltages up to 600 V. For further information, please contact your local sales office.
Rated voltage (UL 1977)	600 V
Rated current UL 1977	23 A

Subject to changes. Please also observe the further product documentation!

WAGO GmbH & Co. KG  
 Hansastr. 27  
 32423 Minden  
 Phone: +49571 887-0 | Fax: +49571 887-169  
 Email: [info.de@wago.com](mailto:info.de@wago.com) | Web: [www.wago.com](http://www.wago.com)

Do you have any questions about our products?  
 We are always happy to take your call at +49 (571) 887-44222.



## General information

Note on contact resistance	approx. 1 mΩ of contact resistance approx. 0.25 mΩ contact transition plug/socket
----------------------------	--

## Connection data

Total number of potentials	4
Number of levels	1

## Connection 1

Pole number	4
-------------	---

## Physical data

Pin spacing	10 mm / 0.394 inches
Width	37 mm / 1.457 inches
Height	18.1 mm / 0.713 inches
Height from the surface	14.6 mm / 0.575 inches
Depth	26 mm / 1.024 inches
Solder pin length	3.5 mm
Solder pin dimensions	1 x 0.8 mm
Drilled hole diameter with tolerance	1.5 <sup>(-0.1 ... +0.1)</sup> mm

## Mechanical Data

Application	General mains applications
Coding	A
Variable coding	Yes
Marking	N $\frac{2}{L}$ 1/L'
Potential marking	N $\frac{2}{L}$ 1/L'
Mating force of a plug-in connection	approx. 20 ... 70 N (depending on pole number)
Retention force of a plug-in connection	Locked: > 80 N
Unmating force of a plug-in connection	Unlocked: approx. 20 ... 70 N (depending on pole number)
Number of mating cycles	200, without resistive load
Design	angled

## Plug-in connection

Contact type (pluggable connector)	Female connector/socket
------------------------------------	-------------------------

Subject to changes. Please also observe the further product documentation!



Connector (connection type)	for PCB
Mismating protection	Yes
Note on mismating protection	All <i>WINSTA</i> <sup>®</sup> components are 100% protected against mismating when: a.) plugging different numbers of poles b.) plugging while rotated 180 c.) plugging while laterally staggered d.) plugging one pole
Mating direction to the PCB	0°
Locking lever	yes
Locking of plug-in connection	locking lever
Note on locking system	All connectors for mounted installations (snap-in versions for lighting fixtures or devices, all types of PCB and distribution connectors) are factory-equipped with locking levers to ensure plugs and sockets are securely locked. Additional locking levers are only required for flying leads (plug/socket).

### PCB contact

PCB contact	THT
Solder pin arrangement	2 in-line solder pins/pole
Number of solder pins per potential	2

### Material data

Note (material data)	Information on material specifications can be found here
Color	black
Insulation material	Polyamide (PA66)
Flammability class per UL94	V0
Clamping spring material	Chrome-nickel spring steel (CrNi)
Contact material	Copper or copper alloy; surface-treated
Contact plating	Tin
Fire load	0.184 MJ
Weight	8.5 g

### Environmental requirements

Processing temperature	-5 ... +40 °C
Continuous operating temperature	-35 ... +85 °C
Note on continuous operating temperature	Insulating parts for temperatures ≤ 105 °C

Subject to changes. Please also observe the further product documentation!

WAGO GmbH & Co. KG  
Hansastr. 27  
32423 Minden  
Phone: +49571 887-0 | Fax: +49571 887-169  
Email: [info.de@wago.com](mailto:info.de@wago.com) | Web: [www.wago.com](http://www.wago.com)

Do you have any questions about our products?  
We are always happy to take your call at +49 (571) 887-44222.

## Commercial data



eCl@ss 10.0	27-44-06-05
eCl@ss 9.0	27-44-06-05
ETIM 8.0	EC002560
ETIM 7.0	EC002560
ECCN	NO DATA
PU (SPU)	50 pcs
Packaging type	box
Country of origin	PL
GTIN	4044918684736
Customs tariff number	85366990990

## Environmental Product Compliance

RoHS Compliance Status	Compliant, No Exemption
------------------------	-------------------------

## Approvals / Certificates

### General approvals

Logo	Approval	Additional Approval Text	Certificate name
	CCA DEKRA Certification B.V.	EN 61535	71- 123228
	CCA DEKRA Certification B.V.	IEC 61535	NL -84761
	cURus Underwriters Laboratories Inc.	UL 1977	E45171

### Declarations of conformity and manufacturer's declarations



Logo	Approval	Additional Approval Text	Certificate name
	EU-Declaration of Conformity WAGO GmbH & Co. KG	-	-

### Approvals for marine applications





Subject to changes. Please also observe the further product documentation!

WAGO GmbH & Co. KG  
 Hansastr. 27  
 32423 Minden  
 Phone: +49571 887-0 | Fax: +49571 887-169  
 Email: [info.de@wago.com](mailto:info.de@wago.com) | Web: [www.wago.com](http://www.wago.com)



Do you have any questions about our products?  
 We are always happy to take your call at +49 (571) 887-44222.

Logo	Approval	Additional Approval Text	Certificate name
	<b>ABS</b> American Bureau of Shipping	-	19- HG1868589- PDA
	<b>DNV GL</b> Det Norske Veritas, Germanischer Lloyd	-	TAE00001Z6
	<b>LR</b> Lloyds Register	IEC 61984	LR22429487TA

### Counterpart

	<b>Item no.770-114</b> Plug; with strain relief housing; 4-pole; Cod. A; 4,00 mm <sup>2</sup> ; black	<a href="http://www.wago.com/770-114">www.wago.com/770-114</a>
	<b>Item no.771-9994/006-101</b> pre-assembled interconnecting cable; Eca; Socket/plug; 4-pole; Cod. A; H05VV-F 4G 1.5 mm <sup>2</sup> ; 1 m; 1,50 mm <sup>2</sup> ; black	<a href="http://www.wago.com/771-9994/006-101">www.wago.com/771-9994/006-101</a>
	<b>Item no.771-9994/206-101</b> pre-assembled connecting cable; Eca; Plug/open-ended; 4-pole; Cod. A; H05VV-F 4G 1.5 mm <sup>2</sup> ; 1 m; 1,50 mm <sup>2</sup> ; black	<a href="http://www.wago.com/771-9994/206-101">www.wago.com/771-9994/206-101</a>
	<b>Item no.770-214</b> Plug; 4-pole; Cod. A; 4,00 mm <sup>2</sup> ; black	<a href="http://www.wago.com/770-214">www.wago.com/770-214</a>

### Required accessories

Cover		
Cover		
	<b>Item no.: 770-201</b> Lockout cap; 12-pole, separable; for sockets; Plastic; black	<a href="http://www.wago.com/770-201">www.wago.com/770-201</a>
	<b>Item no.: 770-221</b> Lockout cap; 12-pole, separable; for sockets; Plastic; white	<a href="http://www.wago.com/770-221">www.wago.com/770-221</a>

Subject to changes. Please also observe the further product documentation!



## Downloads

### CAD/CAE-Data

#### CAD data

2D/3D Models 770-804/011-000	<a href="#">URL</a>	<a href="#">Download</a>
------------------------------	---------------------	--------------------------

#### CAE data

EPLAN Data Portal 770-804/011-000	<a href="#">URL</a>	<a href="#">Download</a>
-----------------------------------	---------------------	--------------------------

ZUKEN Portal 770-804/011-000	<a href="#">URL</a>	<a href="#">Download</a>
------------------------------	---------------------	--------------------------

EPLAN Data Portal 770-804/011-000	<a href="#">URL</a>	<a href="#">Download</a>
-----------------------------------	---------------------	--------------------------

#### PCB Design

Symbol and Footprint 770-804/011-000	<a href="#">URL</a>	<a href="#">Download</a>
--------------------------------------	---------------------	--------------------------

CAx data for your PCB design, consisting of "schematic symbols and PCB footprints", allow easy integration of the WAGO component into your development environment.

#### Supported formats:

- Accel EDA 14 & 15
- Altium 6 to current version
- Cadence Allegro
- DesignSpark
- Eagle Libraries
- KiCad
- Mentor Graphics BoardStation
- Mentor Graphics Design Architect
- Mentor Graphics Design Expedition 99 and 2000
- OrCAD 9.X PCB and Capture
- PADS PowerPCB 3, 3.5, 4.X, and 5.X
- PADS PowerPCB and PowerLogic 3.0
- PCAD 2000, 2001, 2002, 2004, and 2006
- Pulsonix 8.5 or newer
- STL
- 3D STEP
- TARGET 3001!

—  
Subject to changes. Please also observe the further product documentation!



- View Logic ViewDraw
- Quadcept
- Zuken CadStar 3 and 4
- Zuken CR-5000 and CR-8000

PCB Component Libraries (EDA), PCB CAD Library Ultra Librarian

---

#### Asset Administration Shell

Asset Administration Shell 770-804/011-000	URL	Download
--	-----	----------

---

#### Environmental Product Compliance

##### Compliance Search

Environmental Product Compliance 770-804/011-000	URL	Download
--	-----	----------

Socket for PCBs; angled; 4-pole; Cod. A; black

---

#### Installation Notes

#### Product family

**WINSTA® MIDI**

[Show all products from the family](#)

Subject to changes. Please also observe the further product documentation!