

Data sheet | Item number: 769-109/000-037

1-conductor female connector; CAGE CLAMP®; 4 mm<sup>2</sup>; Pin spacing 5 mm; 9-pole; coding finger; 4,00 mm<sup>2</sup>; gray, green-yellow

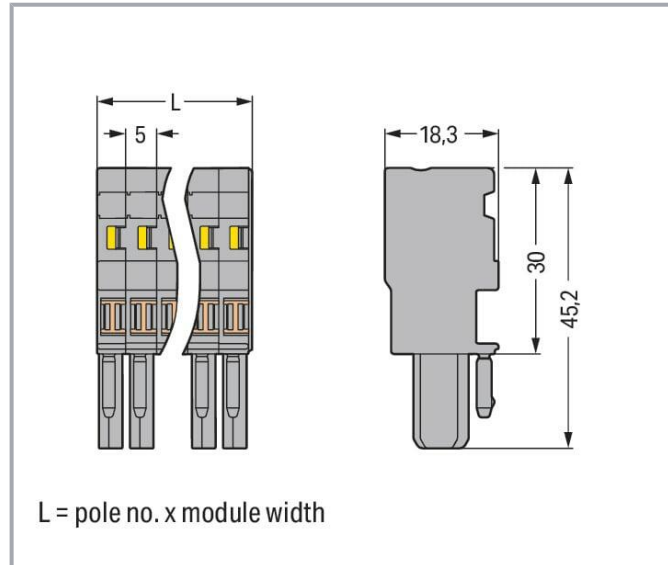

[www.wago.com/769-109/000-037](http://www.wago.com/769-109/000-037)



## Data

### Notes

Safety information

According to EN 61984, pluggable connectors without current interrupting capacity must not be mated or unmated when live or under load.

## Electrical data

Subject to changes. Please also observe the further product documentation!

WAGO GmbH & Co. KG  
Hansastr. 27  
32423 Minden  
Phone: +49571 887-0 | Fax: +49571 887-169  
Email: [info.de@wago.com](mailto:info.de@wago.com) | Web: [www.wago.com](http://www.wago.com)

Do you have any questions about our products?  
We are always happy to take your call at +49 (571) 887-44222.



## Ratings per IEC/EN

Ratings per	IEC/EN 61984
Nominal voltage (III/3)	500 V
Rated impulse voltage (III/3)	6 kV
Rated current	32 A
Legend (ratings)	(III / 3) ≙ Overvoltage category III / Pollution degree 3

## Connection data

Connection points	9
Total number of potentials	9

## Connection 1

Connection technology	CAGE CLAMP®
Actuation type	Operating tool
Connectable conductor materials	Copper
Nominal cross-section	4 mm <sup>2</sup> / 12 AWG
Solid conductor	0.08 ... 4 mm <sup>2</sup> / 28 ... 12 AWG
Fine-stranded conductor	0.08 ... 4 mm <sup>2</sup> / 28 ... 12 AWG
Strip length	8 ... 9 mm / 0.31 ... 0.35 inches
Pole number	9
Wiring direction	Front-entry wiring

## Physical data

Width	45 mm / 1.772 inches
Height	45.2 mm / 1.78 inches
Depth	18.3 mm / 0.72 inches
Module width	5 mm / 0.197 inches

## Mechanical Data

Variable coding	Yes
Direct ground contact to DIN-rail/drilled hole/housing	No
Marking level	Side marking
Anti-rotation protection	Yes

Subject to changes. Please also observe the further product documentation!

WAGO GmbH & Co. KG  
 Hansastr. 27  
 32423 Minden  
 Phone: +49571 887-0 | Fax: +49571 887-169  
 Email: [info.de@wago.com](mailto:info.de@wago.com) | Web: [www.wago.com](http://www.wago.com)

Do you have any questions about our products?  
 We are always happy to take your call at +49 (571) 887-44222.



## Plug-in connection

Contact type (pluggable connector)	Female connector/socket
Connector (connection type)	for conductor
Mismatching protection	No
Plugging without loss of pin spacing	Yes

## Material data

Note (material data)	Information on material specifications can be found here
Color	gray/green-yellow
Material group	I
Insulation material	Polyamide (PA66)
Flammability class per UL94	V0
Fire load	0.556 MJ
Halogen-free	Yes
Weight	28.4 g

## Environmental requirements

Processing temperature	-35 ... +85 °C
Continuous operating temperature	-60 ... +105 °C

## Commercial data

eCl@ss 10.0	27-14-11-06
eCl@ss 9.0	27-14-11-06
ETIM 8.0	EC001284
ETIM 7.0	EC001284
ECCN	NO DATA
PU (SPU)	25 pcs
Packaging type	box
Country of origin	DE
GTIN	4045454156565
Customs tariff number	85366990990

Subject to changes. Please also observe the further product documentation!

WAGO GmbH & Co. KG  
 Hansastr. 27  
 32423 Minden  
 Phone: +49571 887-0 | Fax: +49571 887-169  
 Email: [info.de@wago.com](mailto:info.de@wago.com) | Web: [www.wago.com](http://www.wago.com)

Do you have any questions about our products?  
 We are always happy to take your call at +49 (571) 887-44222.



## Environmental Product Compliance

RoHS Compliance Status

Compliant, No Exemption

## Approvals / Certificates

### General approvals

Logo	Approval	Additional Approval Text	Certificate name
	CSA CSA Group	C22.2	1101144
	UL Underwriters Laboratories Inc.	UL 1977	E 45171
	UR Underwriters Laboratories Inc.	UL 1059	E45172

## Optional accessories

### Testing and measuring

#### Testing accessories



Item no.: 210-136

Test plug; 2 mm Ø; with 500 mm cable; red

[www.wago.com/210-136](http://www.wago.com/210-136)

### Locking levers

#### Locking system



Item no.: 769-430

Locking lever; for female connectors; 1 part; Pin spacing 5 mm; 2-pole; gray

[www.wago.com/769-430](http://www.wago.com/769-430)

Item no.: 769-431

Locking lever; for female connectors; 1 part; Pin spacing 5 mm; 2-pole; orange

[www.wago.com/769-431](http://www.wago.com/769-431)

### Protective warning marker

#### Cover



Item no.: 280-415

Protective warning marker; for 5 terminal blocks; with high-voltage symbol, black; yellow

[www.wago.com/280-415](http://www.wago.com/280-415)

Subject to changes. Please also observe the further product documentation!

WAGO GmbH &amp; Co. KG

Hansastr. 27

32423 Minden

Phone: +49571 887-0 | Fax: +49571 887-169

Email: [info.de@wago.com](mailto:info.de@wago.com) | Web: [www.wago.com](http://www.wago.com)

Do you have any questions about our products?

We are always happy to take your call at +49 (571) 887-44222.

### Insulation stop

#### Insulation stop



**Item no.: 769-470**  
Insulation stop; 0.08 - 0.2 mm<sup>2</sup> "s" (0.14 mm<sup>2</sup> "f-st"); 5 pieces/strip; white

[www.wago.com/769-470](http://www.wago.com/769-470)



**Item no.: 769-471**  
Insulation stop; 0.25 - 0.5 mm<sup>2</sup>; 5 pieces/strip; light gray

[www.wago.com/769-471](http://www.wago.com/769-471)



**Item no.: 769-472**  
Insulation stop; 0.75 - 1 mm<sup>2</sup>; 5 pieces/strip; dark gray

[www.wago.com/769-472](http://www.wago.com/769-472)

### Marking accessories

#### Marking strip



**Item no.: 210-831**  
Marking strips; on reel; 2.3 mm wide; plain; Self-adhesive; white

[www.wago.com/210-831](http://www.wago.com/210-831)



**Item no.: 210-834**  
Marking strips; on reel; 5 mm wide; plain; Self-adhesive; white

[www.wago.com/210-834](http://www.wago.com/210-834)



**Item no.: 210-832**  
Marking strips; on reel; 3 mm wide; plain; Self-adhesive; white

[www.wago.com/210-832](http://www.wago.com/210-832)

#### Label



**Item no.: 210-805**  
Labels; for Smart Printer; permanent adhesive; 6 x 15 mm; white

[www.wago.com/210-805](http://www.wago.com/210-805)



**Item no.: 210-805/000-002**  
Labels; for Smart Printer; permanent adhesive; 6 x 15 mm; yellow

[www.wago.com/210-805/000-002](http://www.wago.com/210-805/000-002)

#### Marker



**Item no.: 2009-145**  
Mini-WSB Inline; for Smart Printer; 1700 pieces on roll; stretchable 5 - 5.2 mm; plain; snap-on type; white

[www.wago.com/2009-145](http://www.wago.com/2009-145)



**Item no.: 248-501**  
Mini-WSB marking card; as card; not stretchable; plain; snap-on type; white

[www.wago.com/248-501](http://www.wago.com/248-501)

### Jumpers

#### Jumper



**Item no.: 769-402**  
Jumper; insulated; gray

[www.wago.com/769-402](http://www.wago.com/769-402)

### Cover

#### Cover











Subject to changes. Please also observe the further product documentation!

**Item no.: 769-436**

Jumper cover; for 1-conductor female plugs; for 5 poles; gray

[www.wago.com/769-436](http://www.wago.com/769-436)**Ferrule**

## Ferrule

	<b>Item no.: 216-101</b> Ferrule; Sleeve for 0.5 mm <sup>2</sup> / AWG 22; uninsulated; electro-tin plated; silver-colored	<a href="http://www.wago.com/216-101">www.wago.com/216-101</a>
	<b>Item no.: 216-104</b> Ferrule; Sleeve for 1.5 mm <sup>2</sup> / AWG 16; uninsulated; electro-tin plated; silver-colored	<a href="http://www.wago.com/216-104">www.wago.com/216-104</a>
	<b>Item no.: 216-102</b> Ferrule; Sleeve for 0.75 mm <sup>2</sup> / AWG 20; uninsulated; electro-tin plated; silver-colored	<a href="http://www.wago.com/216-102">www.wago.com/216-102</a>
	<b>Item no.: 216-103</b> Ferrule; Sleeve for 1 mm <sup>2</sup> / AWG 18; uninsulated; electro-tin plated	<a href="http://www.wago.com/216-103">www.wago.com/216-103</a>
	<b>Item no.: 216-203</b> Ferrule; Sleeve for 1 mm <sup>2</sup> / AWG 18; insulated; electro-tin plated; red	<a href="http://www.wago.com/216-203">www.wago.com/216-203</a>
	<b>Item no.: 216-206</b> Ferrule; Sleeve for 2.5 mm <sup>2</sup> / AWG 14; insulated; electro-tin plated; blue	<a href="http://www.wago.com/216-206">www.wago.com/216-206</a>
	<b>Item no.: 216-202</b> Ferrule; Sleeve for 0.75 mm <sup>2</sup> / 18 AWG; insulated; electro-tin plated; gray	<a href="http://www.wago.com/216-202">www.wago.com/216-202</a>
	<b>Item no.: 216-204</b> Ferrule; Sleeve for 1.5 mm <sup>2</sup> / AWG 16; insulated; electro-tin plated; black	<a href="http://www.wago.com/216-204">www.wago.com/216-204</a>
	<b>Item no.: 216-201</b> Ferrule; Sleeve for 0.5 mm <sup>2</sup> / 20 AWG; insulated; electro-tin plated; white	<a href="http://www.wago.com/216-201">www.wago.com/216-201</a>
	<b>Item no.: 216-301</b> Ferrule; Sleeve for 0.25 mm <sup>2</sup> / AWG 24; insulated; electro-tin plated; yellow	<a href="http://www.wago.com/216-301">www.wago.com/216-301</a>
	<b>Item no.: 216-302</b> Ferrule; Sleeve for 0.34 mm <sup>2</sup> / 22 AWG; insulated; electro-tin plated; light turquoise	<a href="http://www.wago.com/216-302">www.wago.com/216-302</a>

**Strain relief**

## Strain relief

**Item no.: 769-1609**

Strain relief housing; for female and male connectors; 2 parts; Pin spacing 5 mm; 9-pole; gray

[www.wago.com/769-1609](http://www.wago.com/769-1609)**Item no.: 769-413**

Strain relief plate; for female and male connectors; 1 part; Pin spacing 5 mm; 6- to 9-pole; gray

[www.wago.com/769-413](http://www.wago.com/769-413)**Tool**

## Operating tool

**Item no.: 210-490**

Operating tool

[www.wago.com/210-490](http://www.wago.com/210-490)

Subject to changes. Please also observe the further product documentation!

WAGO GmbH &amp; Co. KG

Hansastr. 27

32423 Minden

Phone: +49571 887-0 | Fax: +49571 887-169

Email: [info.de@wago.com](mailto:info.de@wago.com) | Web: [www.wago.com](http://www.wago.com)

Do you have any questions about our products?

We are always happy to take your call at +49 (571) 887-44222.



Item no.: 769-434

Operating tool; made of insulating material; 1-way; loose; white

## Downloads

### Documentation

#### Bid Text

769-109/000-037 X81 - Datei	2019 Feb 19	xml 3.3 kB	Download
--------------------------------	-------------	---------------	----------

769-109/000-037 doc - Datei	2017 Oct 4	doc 26.1 kB	Download
--------------------------------	------------	----------------	----------

#### Additional Information

		pdf 2.3 MB	Download
--	--	---------------	----------

## CAD/CAE-Data

### CAE data

EPLAN Data Portal 769-109/000-037	URL	Download
-----------------------------------	-----	----------

WSCAD Universe 769-109/000-037	URL	Download
--------------------------------	-----	----------

WSCAD Universe 769-109/000-037	URL	Download
--------------------------------	-----	----------

EPLAN Data Portal 769-109/000-037	URL	Download
-----------------------------------	-----	----------

## Environmental Product Compliance

### Compliance Search

Environmental Product Compliance 769-109/000-037 1-conductor female connector; CAGE CLAMP®; 4 mm <sup>2</sup> ; Pin spacing 5 mm; 9-pole; coding finger; 4,00 mm <sup>2</sup> ; gray, green-yellow	URL	Download
--	-----	----------

## Installation Notes

### Conductor termination

Subject to changes. Please also observe the further product documentation!

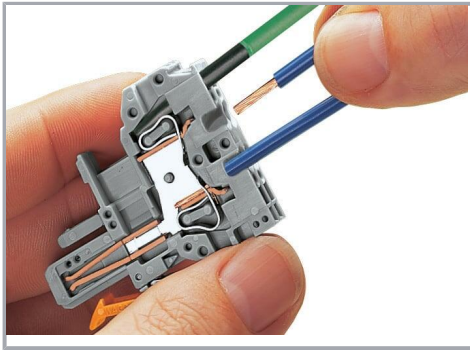

#### CAGE CLAMP® connection

Female plug: Inserting/removing a conductor via operating tool.

Operation 90° to conductor is also possible. With ferruled conductors, it is necessary to use a terminal block one size smaller than the conductor's nominal cross-section.

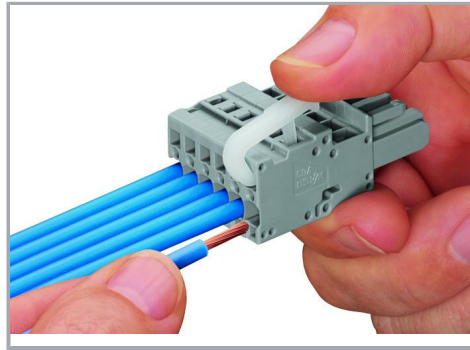

#### Operating lever

Inserting a conductor – side-entry wiring (example shows a female plug).

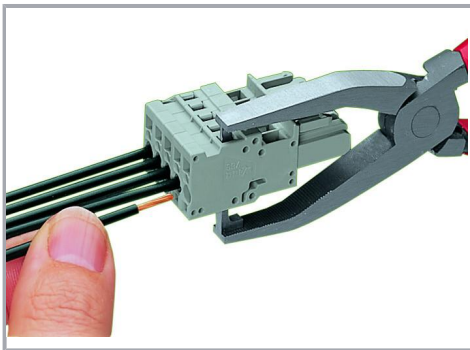

#### Operating tool

Inserting a conductor – side-entry wiring (example shows a female plug).

With ferruled conductors, it is necessary to use a terminal block one size smaller than the conductor's nominal cross-section.

#### Commoning

Subject to changes. Please also observe the further product documentation!



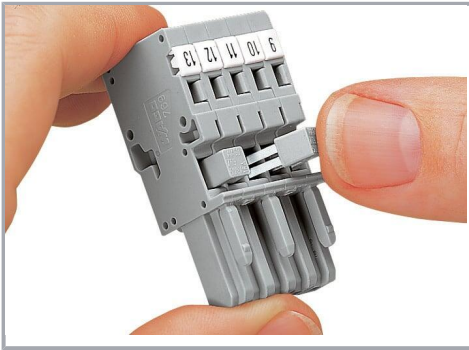

Commoning 1-conductor female plugs via miniature adjacent jumpers.

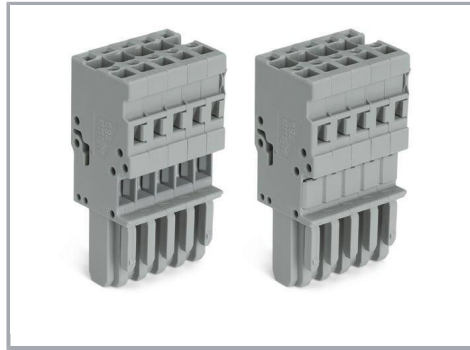

Jumper cover for 1-conductor female plugs

### Coding



Coding a female plug by removing coding finger(s) via cutting tool. Do not remove the first and last coding fingers or use an additional locking lever.

### Locking system

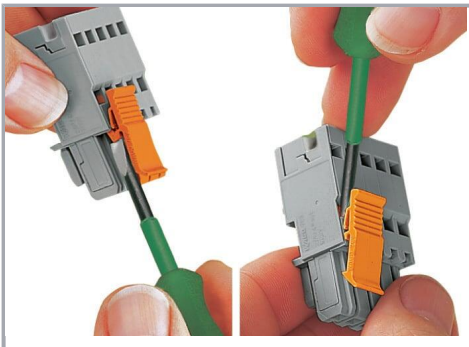

Locking/releasing a lever.

### Strain relief

Subject to changes. Please also observe the further product documentation!

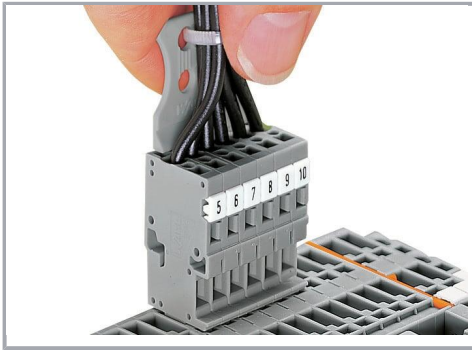

Removing a female plug via conductor bundle provided with strain relief plate.

### Marking

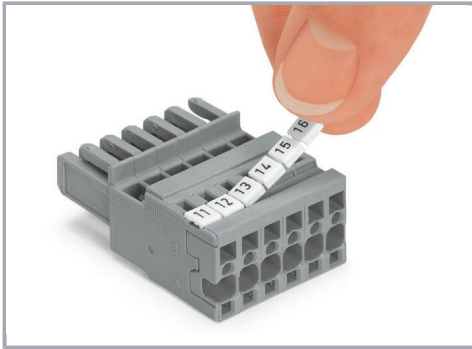

Labeling a female plug with CAGE CLAMP® connection via Mini-WSB Quick Markers.

### Product family

**X-COM**

[Show all products from the family](#)

Subject to changes. Please also observe the further product documentation!