

Data sheet | Item number: 2091-1106/000-1000

1-conductor female connector; push-button; Push-in CAGE CLAMP®; 1.5 mm²; Pin spacing 3.5 mm; 6-pole; Gripping plate; direct marking; 1,50 mm²; light gray

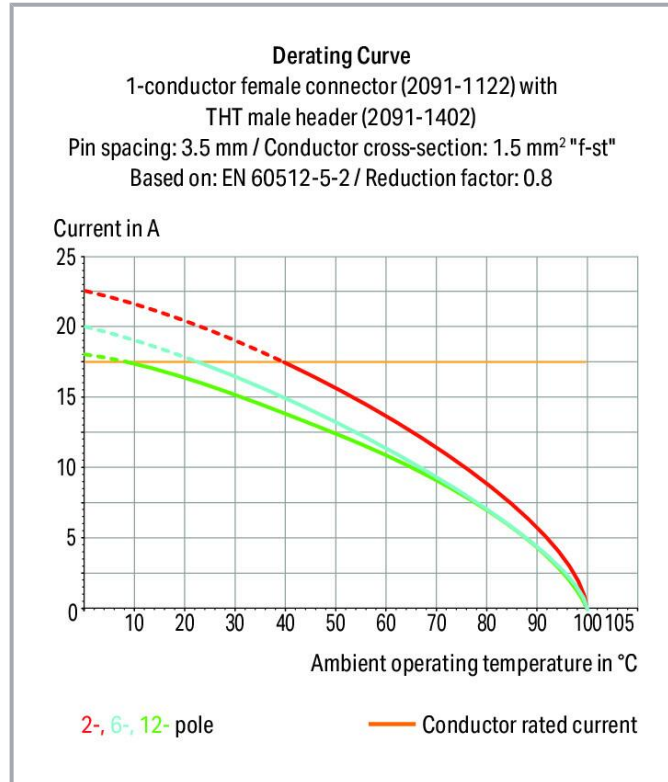

www.wago.com/2091-1106/000-1000



Subject to changes. Please also observe the further product documentation!

WAGO GmbH & Co. KG
Hansastr. 27
32423 Minden
Phone: +49571 887-0 | Fax: +49571 887-169
Email: info.de@wago.com | Web: www.wago.com

Do you have any questions about our products?
We are always happy to take your call at +49 (571) 887-44222.

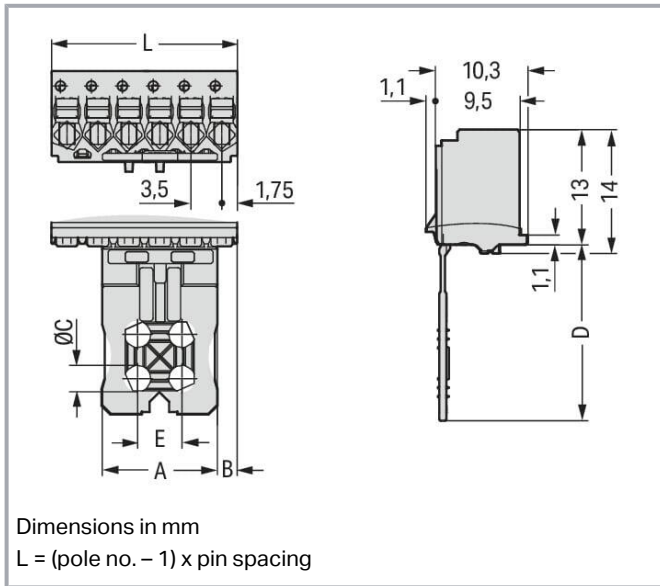

| Gripping plate Dimensions (in mm): | | | | | |
|------------------------------------|----|------|-----|----|---|
| Polzahl | A | B | C | D | E |
| 2 | 6 | 0.45 | - | 17 | - |
| 3 | 6 | 2.20 | - | 17 | - |
| 4 | 6 | 2.20 | - | 17 | - |
| 5 | 13 | 2.25 | 3.0 | 20 | 5 |
| 6 | 13 | 2.25 | 3.0 | 20 | 5 |
| 7 | 13 | 5.75 | 3.0 | 20 | 5 |
| 8 | 13 | 5.75 | 3.0 | 20 | 5 |
| 10 | 27 | 2.25 | 4.2 | 25 | 8 |
| 12 | 27 | 5.75 | 4.2 | 25 | 8 |

Item description

- Universal connection for all conductor types
- Simple, push-in termination of solid and ferruled conductors
- Easy-to-use design does not require specialty tools
- Ability to wire while mated or unmated
- Test port parallel to conductor entry – touch contact
- Integrated locking latches prevent accidental disconnection

Data

Notes

Safety information

The **picoMAX® Pluggable Connection System** includes connectors without breaking capacity in accordance with DIN EN 61984. When used as intended, these connectors must not be connected /disconnected when live or under load. The circuit design should ensure header pins, which can be touched, are not live when unmated.

Variants:

Direct marking

Other versions (or variants) can be requested from WAGO Sales or configured at <https://configurator.wago.com/>.

Electrical data

Subject to changes. Please also observe the further product documentation!

WAGO GmbH & Co. KG

Hansastr. 27

32423 Minden

Phone: +49571 887-0 | Fax: +49571 887-169

Email: info.de@wago.com | Web: www.wago.com

Do you have any questions about our products?

We are always happy to take your call at +49 (571) 887-44222.



Ratings per IEC/EN

| | |
|-------------------------------|---|
| Ratings per | IEC/EN 60664-1 |
| Nominal voltage (III/3) | 160 V |
| Rated impulse voltage (III/3) | 2.5 kV |
| Rated voltage (III/2) | 160 V |
| Rated impulse voltage (III/2) | 2.5 kV |
| Nominal voltage (II/2) | 320 V |
| Rated surge voltage (II/2) | 2.5 kV |
| Rated current | 10 A |
| Legend (ratings) | (III / 2) $\hat{=}$ Overvoltage category III / Pollution degree 2 |

Ratings per UL

| | |
|--------------------------------|---------|
| Approvals per | UL 1059 |
| Rated voltage UL (Use Group B) | 300 V |
| Rated current UL (Use Group B) | 10 A |
| Rated voltage UL (Use Group D) | 300 V |
| Rated current UL (Use Group D) | 10 A |

Connection data

| | |
|----------------------------|---|
| Connection points | 6 |
| Total number of potentials | 6 |
| Number of connection types | 1 |
| Number of levels | 1 |

Connection 1

| | |
|---|---|
| Connection technology | Push-in CAGE CLAMP® |
| Actuation type | Push-button |
| Actuation direction 1 | Operation parallel to conductor entry |
| Solid conductor | 0.2 ... 1.5 mm ² / 24 ... 14 AWG |
| Fine-stranded conductor | 0.2 ... 1.5 mm ² / 24 ... 14 AWG |
| Fine-stranded conductor; with insulated ferrule | 0.25 ... 0.75 mm ² |
| Fine-stranded conductor; with uninsulated ferrule | 0.25 ... 1.5 mm ² |
| Strip length | 8 ... 9 mm / 0.31 ... 0.35 inches |
| Pole number | 6 |

Subject to changes. Please also observe the further product documentation!



Physical data

| | |
|-------------|------------------------|
| Pin spacing | 3.5 mm / 0.138 inches |
| Width | 21 mm / 0.827 inches |
| Height | 33 mm / 1.299 inches |
| Depth | 11.4 mm / 0.449 inches |

Mechanical Data

| | |
|--------------------------|---------------------|
| Variable coding | Yes |
| Design | With gripping plate |
| Anti-rotation protection | Yes |

Plug-in connection

| | |
|--------------------------------------|-------------------------|
| Contact type (pluggable connector) | Female connector/socket |
| Connector (connection type) | for conductor |
| Mismating protection | No |
| Plugging without loss of pin spacing | Yes |
| Locking of plug-in connection | none |

Material data

| | |
|-----------------------------|--|
| Note (material data) | Information on material specifications can be found here |
| Color | light gray |
| Material group | I |
| Insulation material | Polyphthalamide (PPA GF) |
| Flammability class per UL94 | V0 |
| Clamping spring material | Chrome-nickel spring steel (CrNi) |
| Contact material | Electrolytic copper (E _{Cu}) |
| Contact plating | Tin |
| Fire load | 0.07 MJ |
| Weight | 2.8 g |

Environmental requirements

| | |
|-------------------------|-----------------|
| Limit temperature range | -60 ... +100 °C |
| Processing temperature | -35 ... +60 °C |

Subject to changes. Please also observe the further product documentation!

WAGO GmbH & Co. KG
 Hansastr. 27
 32423 Minden
 Phone: +49571 887-0 | Fax: +49571 887-169
 Email: info.de@wago.com | Web: www.wago.com

Do you have any questions about our products?
 We are always happy to take your call at +49 (571) 887-44222.

Commercial data





| | |
|-----------------------|---------------|
| eCl@ss 10.0 | 27-14-11-06 |
| eCl@ss 9.0 | 27-14-11-06 |
| ETIM 8.0 | EC001284 |
| ETIM 7.0 | EC001284 |
| ECCN | NO DATA |
| PU (SPU) | 50 pcs |
| Packaging type | box |
| Country of origin | DE |
| GTIN | 4050821365877 |
| Customs tariff number | 85366990990 |

Environmental Product Compliance

| | |
|------------------------|-------------------------|
| RoHS Compliance Status | Compliant, No Exemption |
|------------------------|-------------------------|



Approvals / Certificates

General approvals

| Logo | Approval | Additional Approval Text | Certificate name |
|--|--|--------------------------|------------------------|
| | CB DEKRA Certification B.V. | IEC 61984 | NL-49736 /A1 |
|  | CSA DEKRA Certification B.V. | C22.2 | 2362521 |
|  | KEMA/KEUR DEKRA Certification B.V. | EN 61984 | 71- 102260 REV.1 |
|  | UL Underwriters Laboratories Inc. | UL 1977 | E45171 |
|  | UR Underwriters Laboratories Inc. | UL 1059 | E45172 |

Subject to changes. Please also observe the further product documentation!

Counterpart

| | | |
|--|--|--|
|  | Item no.2091-1426 THT male header; 1.0 mm Ø solder pin; angled; Pin spacing 3.5 mm; 6-pole; light gray | www.wago.com/2091-1426 |
|  | Item no.2091-1406 THT male header; 1.0 mm Ø solder pin; straight; Pin spacing 3.5 mm; 6-pole; light gray | www.wago.com/2091-1406 |
|  | Item no.2091-1526/002-000 1-conductor male connector; Push-in CAGE CLAMP®; 1.5 mm²; Pin spacing 3.5 mm; 6-pole; Integrated release lever; 1,50 mm²; light gray | www.wago.com/2091-1526/002-000 |

Optional accessories

Tool

Operating tool

| | | |
|--|---|--|
|  | Item no.: 210-719 Operating tool; Blade: 2.5 x 0.4 mm; with a partially insulated shaft | www.wago.com/210-719 |
|--|---|--|

Coding

Coding

| | | |
|--|---|--|
|  | Item no.: 2091-1610 Coding key carrier; suitable for 3.5 mm pin spacing; orange | www.wago.com/2091-1610 |
|--|---|--|

Testing and measuring

Testing accessories

| | | |
|--|---|--|
|  | Item no.: 735-500 WAGO Test pin; 1 mm Ø; 30 V AC / 60 V DC; CAT0; 1 A; 6 mm uninsulated; Test lead for soldering up to 0,5mm² | www.wago.com/735-500 |
|--|---|--|

Downloads

Documentation

Additional Information

| | | | |
|------------------------|------------|--------|----------|
| Technical Section | 2019 Apr 3 | pdf | Download |
| Technical explanations | | 2.1 MB | |

Environmental Product Compliance

Compliance Search

| | | |
|---|-----|----------|
| Environmental Product Compliance 2091-1106/000-1000 | URL | Download |
| 1-conductor female connector; push-button; Push-in CAGE CLAMP®; 1.5 mm²; Pin spacing 3.5 mm; 6-pole; Gripping plate; direct marking; 1,50 mm²; light gray | | |

Subject to changes. Please also observe the further product documentation!

Installation Notes

Locking system

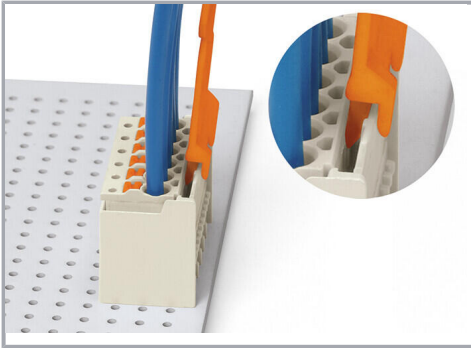

Disconnecting a female connector via unlocking tool. Plug unlocking tool into the male header's locking latch.

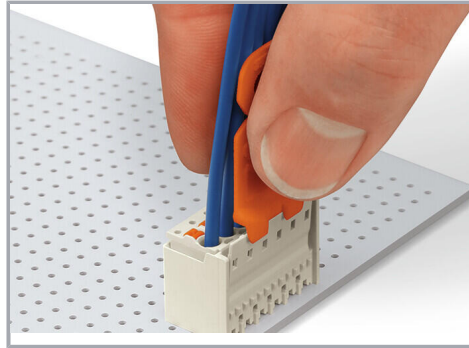

Insert unlocking tool until it hits the backstop. Wedge opens locking latches.

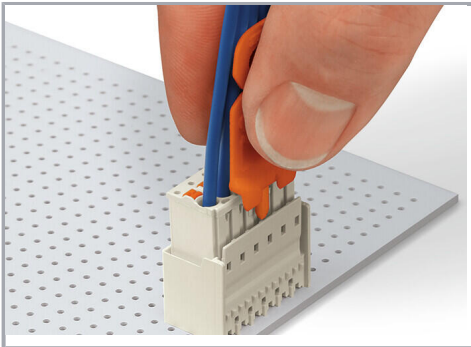

Pull on both unlocking tool and conductors to remove female connector from male header.

Conductor termination

Subject to changes. Please also observe the further product documentation!

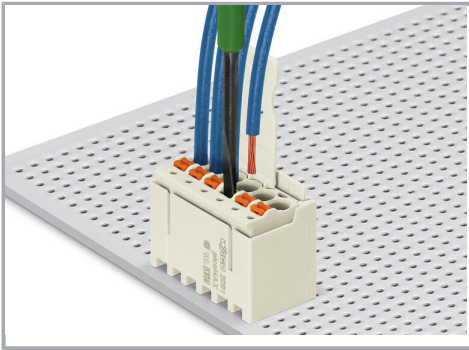

Inserting fine-stranded conductor into mated female connector via push-button.

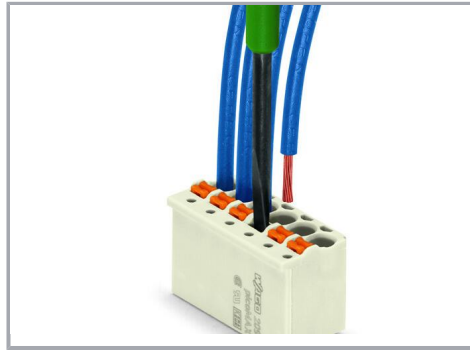

Inserting a fine-stranded conductor into an unmated female connector via push-button.

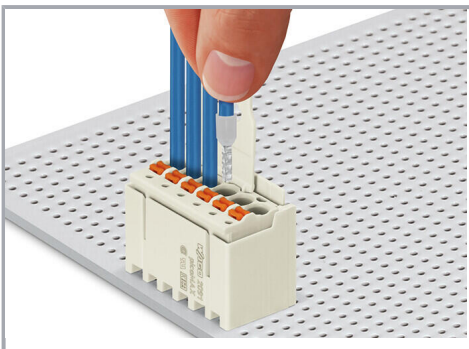

Inserting solid and ferruled conductors via push-in termination.

Marking



Pole marking via factory direct marking.

Coding

Subject to changes. Please also observe the further product documentation!

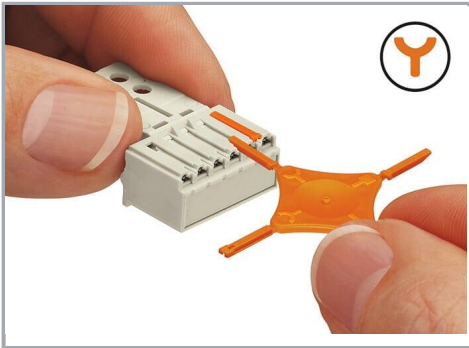

Coding a female connector (via coding key carrier and two keys for female connector, see symbol).

Testing

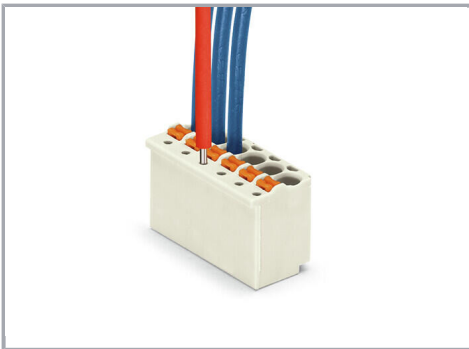

Testing via 1 mm Ø test pin – touch contact.

Subject to changes. Please also observe the further product documentation!