

Data sheet | Item number: 2020-110

1-conductor female connector; Push-in CAGE CLAMP®; 1.5 mm²; Pin spacing 3.5 mm; 10-pole; 1,50 mm²; gray

www.wago.com/2020-110

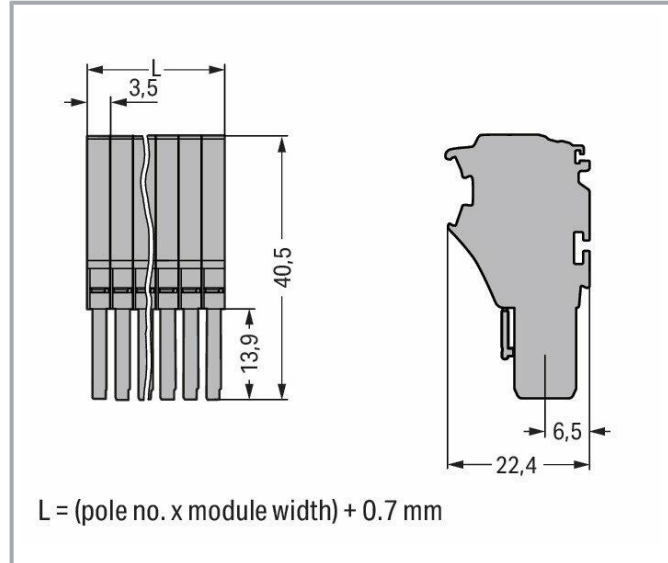
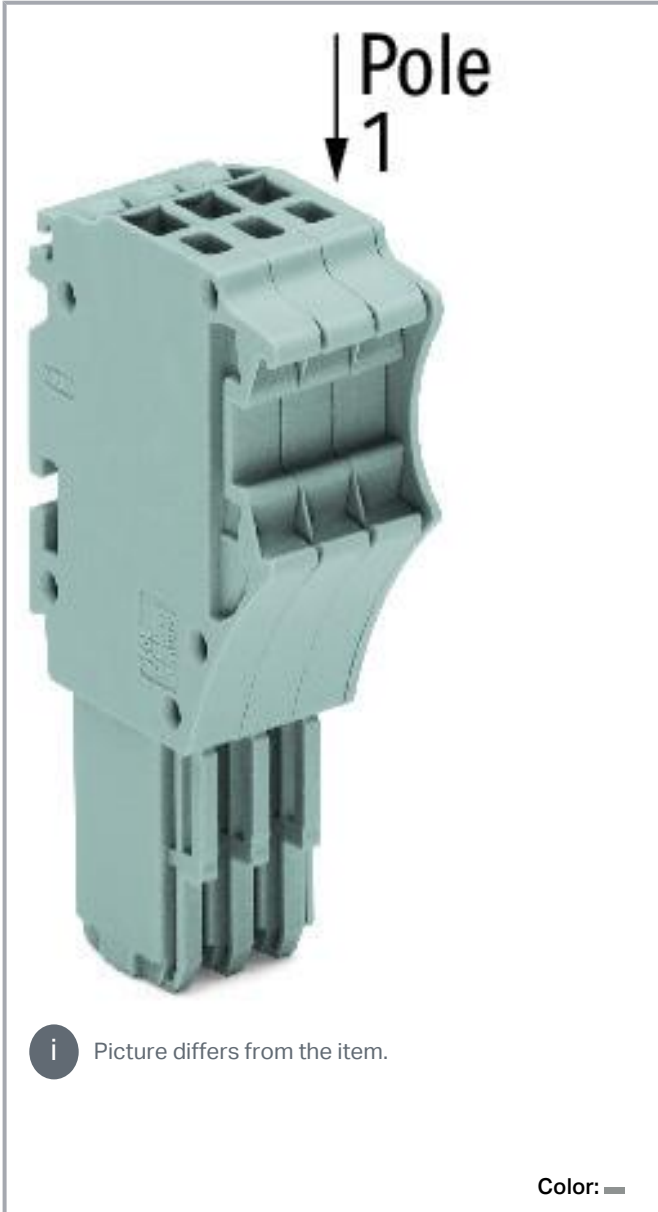

Subject to changes. Please also observe the further product documentation!

WAGO GmbH & Co. KG
Hansastr. 27
32423 Minden
Phone: +49571 887-0 | Fax: +49571 887-169
Email: info.de@wago.com | Web: www.wago.com

Do you have any questions about our products?
We are always happy to take your call at +49 (571) 887-44222.



Data

Notes

Safety information

According to EN 61984, pluggable connectors without current interrupting capacity must not be mated or unmated when live or under load.

Safety information 2

Notice: An appropriate end plate must be applied to the carrier terminal blocks after each female plug.

Electrical data

Ratings per IEC/EN

| Ratings per | IEC/EN 61984 |
|-------------------------------|---|
| Nominal voltage (III/3) | 500 V |
| Rated impulse voltage (III/3) | 6 kV |
| Rated current | 13.5 A |
| Legend (ratings) | (III / 3) ≙ Overvoltage category III / Pollution degree 3 |

Ratings per UL

| Approvals per | UL 1059 |
|--------------------------------|---------|
| Rated voltage UL (Use Group B) | 300 V |
| Rated current UL (Use Group B) | 15 A |
| Rated voltage UL (Use Group C) | 300 V |
| Rated current UL (Use Group C) | 15 A |
| Rated voltage UL (Use Group D) | 300 V |
| Rated current UL (Use Group D) | 15 A |

Ratings per CSA

| Approvals per | CSA 22.2 No 158 |
|---------------------------------|-----------------|
| Rated voltage CSA (Use Group B) | 300 V |
| Rated current CSA (Use Group B) | 10 A |
| Rated voltage CSA (Use Group C) | 300 V |
| Rated current CSA (Use Group C) | 10 A |
| Rated voltage CSA (Use Group D) | 300 V |
| Rated current CSA (Use Group D) | 10 A |

Subject to changes. Please also observe the further product documentation!

WAGO GmbH & Co. KG

Hansastr. 27

32423 Minden

Phone: +49571 887-0 | Fax: +49571 887-169

Email: info.de@wago.com | Web: www.wago.com

Do you have any questions about our products?

We are always happy to take your call at +49 (571) 887-44222.



Connection data

| | |
|----------------------------|----|
| Connection points | 10 |
| Total number of potentials | 10 |

Connection 1

| | |
|--|---|
| Connection technology | Push-in CAGE CLAMP® |
| Actuation type | Operating tool |
| Connectable conductor materials | Copper |
| Nominal cross-section | 1 mm ² |
| Solid conductor | 0.14 ... 1.5 mm ² / 24 ... 16 AWG |
| Solid conductor; push-in termination | 0.5 ... 1.5 mm ² / 20 ... 16 AWG |
| Fine-stranded conductor | 0.14 ... 1.5 mm ² / 24 ... 16 AWG |
| Fine-stranded conductor; with insulated ferrule | 0.14 ... 0.75 mm ² / 24 ... 18 AWG |
| Fine-stranded conductor; with ferrule; push-in termination | 0.5 ... 0.75 mm ² / 20 ... 18 AWG |
| Note (conductor cross-section) | Depending on the conductor characteristic, a conductor with a smaller cross-section can also be inserted via push-in termination. |
| Strip length | 9 ... 11 mm / 0.35 ... 0.43 inches |
| Pole number | 10 |
| Wiring direction | Front-entry wiring |

Physical data

| | |
|--------------|------------------------|
| Width | 35.7 mm / 1.406 inches |
| Height | 40.5 mm / 1.594 inches |
| Depth | 22.4 mm / 0.882 inches |
| Module width | 3.5 mm / 0.138 inches |

Mechanical Data

| | |
|--------------------------|--------------|
| Variable coding | Yes |
| Marking level | Side marking |
| Anti-rotation protection | Yes |

Plug-in connection

| | |
|------------------------------------|-------------------------|
| Contact type (pluggable connector) | Female connector/socket |
| Connector (connection type) | for conductor |
| Mismating protection | No |

Subject to changes. Please also observe the further product documentation!



| | |
|--------------------------------------|----|
| Plugging without loss of pin spacing | No |
|--------------------------------------|----|

Material data

Note (material data)

Information on material specifications can be found here

| | |
|-----------------------------|------------------|
| Color | gray |
| Material group | I |
| Insulation material | Polyamide (PA66) |
| Flammability class per UL94 | V0 |
| Fire load | 0.403 MJ |
| Weight | 22.7 g |

Environmental requirements

| | |
|----------------------------------|-----------------|
| Processing temperature | -35 ... +85 °C |
| Continuous operating temperature | -60 ... +105 °C |

Commercial data

| | |
|-----------------------|---------------|
| eCl@ss 10.0 | 27-14-11-06 |
| eCl@ss 9.0 | 27-14-11-06 |
| ETIM 8.0 | EC001284 |
| ETIM 7.0 | EC001284 |
| ECCN | NO DATA |
| PU (SPU) | 25 pcs |
| Packaging type | Box |
| Country of origin | CN |
| GTIN | 4050821245094 |
| Customs tariff number | 85366990990 |

Environmental Product Compliance

| | |
|------------------------|-------------------------|
| RoHS Compliance Status | Compliant, No Exemption |
|------------------------|-------------------------|

Approvals / Certificates

General approvals

| Logo | Approval | Additional Approval Text | Certificate name |
|------|----------|--------------------------|------------------|
| | CCA | EN 60947 | NTR NL |

Subject to changes. Please also observe the further product documentation!

WAGO GmbH & Co. KG
Hansastr. 27
32423 Minden
Phone: +49571 887-0 | Fax: +49571 887-169
Email: info.de@wago.com | Web: www.wago.com

Do you have any questions about our products?
We are always happy to take your call at +49 (571) 887-44222.



DEKRA Certification B.V.

7617

CSA
DEKRA Certification B.V.

C22.2



2516073

UL
UL International Germany GmbH



UL 1059

E 45172

Declarations of conformity and manufacturer's declarations

| Logo | Approval | Additional Approval Text | Certificate name |
|---|--|--------------------------|------------------|
|  | EU-Declaration of Conformity WAGO GmbH & Co. KG | - | - |
|  | UK-Declaration of Conformity WAGO GmbH & Co. KG | - | - |

Approvals for marine applications

| Logo | Approval | Additional Approval Text | Certificate name |
|---|------------------------------------|--------------------------|--------------------------|
|  | ABS American Bureau of Shipping | EN 60947 | 20- HG1941090- PDA |
|  | BV Bureau Veritas S.A. | EN 60947 | 38586/BO BV |

Optional accessories

Marking accessories

Marking strip

Subject to changes. Please also observe the further product documentation!

WAGO GmbH & Co. KG
 Hansastr. 27
 32423 Minden
 Phone: +49571 887-0 | Fax: +49571 887-169
 Email: info.de@wago.com | Web: www.wago.com

Do you have any questions about our products?
 We are always happy to take your call at +49 (571) 887-44222.



Item no.: 2009-110
Marking strips; for Smart Printer; on reel; not stretchable; plain; snap-on type; white

www.wago.com/2009-110



Item no.: 210-831
Marking strips; on reel; 2.3 mm wide; plain; Self-adhesive; white

www.wago.com/210-831



Item no.: 210-833
Marking strips; 25 m on roll; 6 mm wide; plain; Self-adhesive; white

www.wago.com/210-833



Item no.: 210-834
Marking strips; on reel; 5 mm wide; plain; Self-adhesive; white

www.wago.com/210-834



Item no.: 210-832
Marking strips; on reel; 3 mm wide; plain; Self-adhesive; white

www.wago.com/210-832

Marker



Item no.: 2009-113
WMB-Inline; for Smart Printer; 2300 pieces on roll; plain; snap-on type; white

www.wago.com/2009-113



Item no.: 793-3501
WMB marking card; as card; plain; snap-on type; white

www.wago.com/793-3501

Screwless end stop

Mounting accessories



Item no.: 249-117
Screwless end stop; 10 mm wide; for DIN-rail 35 x 15 and 35 x 7.5; gray

www.wago.com/249-117

Tool

Operating tool



Item no.: 210-648
Operating tool; Blade: 2.5 x 0.4 mm; with a partially insulated shaft; angled; short

www.wago.com/210-648



Item no.: 210-647
Operating tool; Blade: 2.5 x 0.4 mm; with a partially insulated shaft; multicoloured

www.wago.com/210-647



Item no.: 210-719
Operating tool; Blade: 2.5 x 0.4 mm; with a partially insulated shaft

www.wago.com/210-719

Strain relief

Strain relief plate

Subject to changes. Please also observe the further product documentation!





Item no.: 734-326

Strain relief plate; for female and male connectors; 35 mm wide; 1 part; gray

Ferrule

Ferrule

| | | |
|---|--|--|
|  | Item no.: 216-241 Ferrule; Sleeve for 0.5 mm ² / 20 AWG; insulated; electro-tin plated; electrolytic copper; gastight crimped; acc. to DIN 46228, Part 4/09.90; white | www.wago.com/216-241 |
|  | Item no.: 216-242 Ferrule; Sleeve for 0.75 mm ² / 18 AWG; insulated; electro-tin plated; electrolytic copper; gastight crimped; acc. to DIN 46228, Part 4/09.90; gray | www.wago.com/216-242 |
|  | Item no.: 216-243 Ferrule; Sleeve for 1 mm ² / AWG 18; insulated; electro-tin plated; electrolytic copper; gastight crimped; acc. to DIN 46228, Part 4/09.90; red | www.wago.com/216-243 |

Locking levers

Locking system

| | | |
|--|--|--|
|  | Item no.: 2022-151 Locking lever; gray | www.wago.com/2022-151 |
|  | Item no.: 2022-152 Locking lever; orange | www.wago.com/2022-152 |

Protective warning marker

Cover

| | | |
|--|--|--|
|  | Item no.: 2000-115 Protective warning marker; for 5 terminal blocks; with high-voltage symbol, black; yellow | www.wago.com/2000-115 |
|--|--|--|

Downloads

Documentation

Bid Text

| | | | |
|--------------------------|-------------|-----------------|----------|
| 2020-110 X81 - Datei | 2019 Feb 19 | xml 4.0 kB | Download |
| 2020-110 docx - Datei | 2018 Aug 6 | docx 15.4 kB | Download |

Additional Information

pdf
2.3 MB
Download

Subject to changes. Please also observe the further product documentation!

CAD/CAE-Data

CAD data

| | | |
|-----------------------|---------------------|--------------------------|
| 2D/3D Models 2020-110 | URL | Download |
|-----------------------|---------------------|--------------------------|

CAE data

| | | |
|----------------------------|---------------------|--------------------------|
| EPLAN Data Portal 2020-110 | URL | Download |
|----------------------------|---------------------|--------------------------|

| | | |
|-----------------------|---------------------|--------------------------|
| ZUKEN Portal 2020-110 | URL | Download |
|-----------------------|---------------------|--------------------------|

| | | |
|-------------------------|---------------------|--------------------------|
| WSCAD Universe 2020-110 | URL | Download |
|-------------------------|---------------------|--------------------------|

Asset Administration Shell

| | | |
|-------------------------------------|---------------------|--------------------------|
| Asset Administration Shell 2020-110 | URL | Download |
|-------------------------------------|---------------------|--------------------------|

Environmental Product Compliance

Compliance Search

| | | |
|---|---------------------|--------------------------|
| Environmental Product Compliance 2020-110 | URL | Download |
|---|---------------------|--------------------------|

1-conductor female connector; Push-in CAGE CLAMP®; 1.5 mm²; Pin spacing 3.5 mm;
10-pole; 1,50 mm²; gray

Installation Notes

Coding

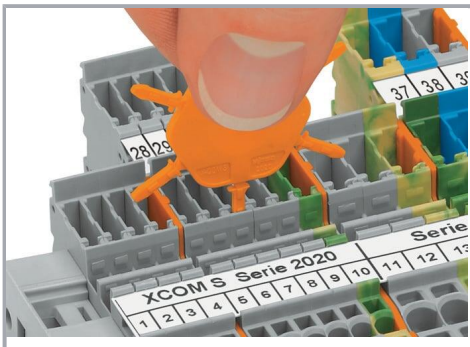

Insert coding pin into the corresponding slot and twist it off.



Coding a female plug: remove coding finger using a suitable tool.

Subject to changes. Please also observe the further product documentation!

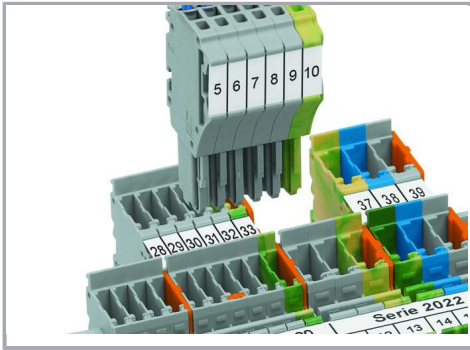

Insert coded female plug into X-COM®S-SYSTEM terminal block assembly.

Locking system

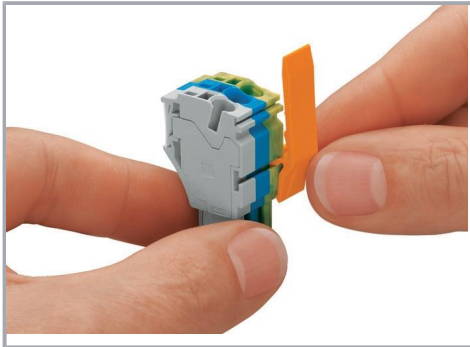

Slide the locking lever into position.

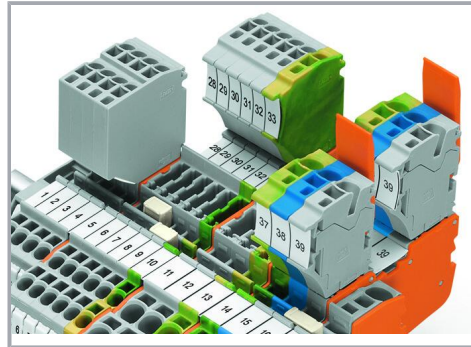

Female plugs can be individually locked.

Product family

X-COM S-Mini

[Show all products from the family](#)

Subject to changes. Please also observe the further product documentation!