

Data sheet | Item number: 770-234  
Plug; 4-pole; Cod. A; 4,00 mm<sup>2</sup>; white

[www.wago.com/770-234](http://www.wago.com/770-234)

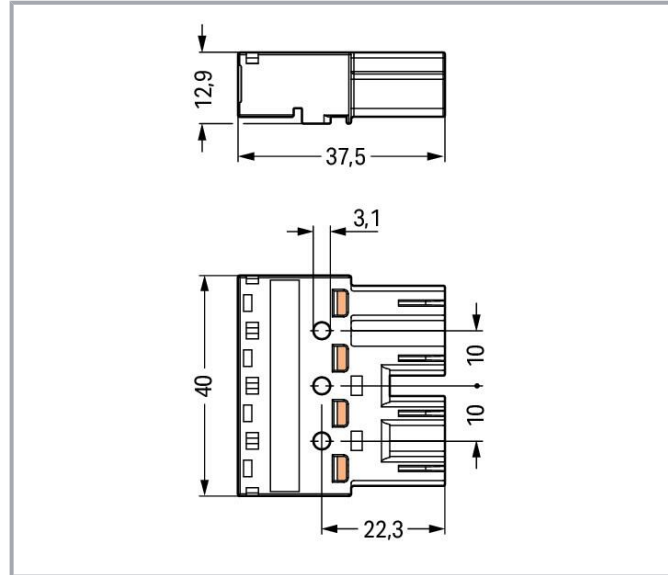
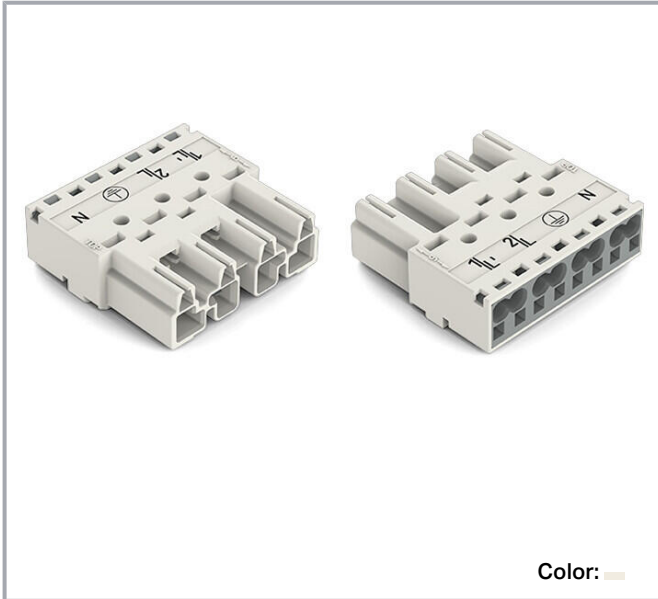

## Item description

### Male connector/plug *WINSTA*® MIDI with protection against mismatching

The *WINSTA*® MIDI male connector/plug rated current 25 A supports fast, reliable installation. On PCBs, in control cabinets or for connecting lights – pluggable installation connectors from WAGO allow you to establish connections according to various requirements in seconds. The coding options reduce installation errors, allowing fast, secure wiring of all components. The pluggable installation connector is protected against ingress by solid objects in accordance with protection type IP20 (When mated and secured with a strain relief housing: IP2xC (These compact connectors are not designed for use in open, easily accessible areas!)). Standard mains applications for almost any domain of use can be implemented with *WINSTA*® MIDI pluggable installation connectors with A coding. This pluggable installation connector can be used for a current load of up to 25 A. Thus, it can also be used for high power loads. The *WINSTA*® MIDI Pluggable Connection System with Push-in CAGE CLAMP® spring pressure connection technology facilitates safe electrification. Thanks to the included test slot, it is possible to check connections even when they are plugged in. This saves time, labor, and money.

### Push-in CAGE CLAMP® spring pressure connection technology – pluggable installation instead of laborious screw connections!

Subject to changes. Please also observe the further product documentation!

WAGO GmbH & Co. KG  
Hansastr. 27  
32423 Minden  
Phone: +49571 887-0 | Fax: +49571 887-169  
Email: [info.de@wago.com](mailto:info.de@wago.com) | Web: [www.wago.com](http://www.wago.com)

Do you have any questions about our products?  
We are always happy to take your call at +49 (571) 887-44222.



WINSTA® is the pluggable connection system that is perfectly tailored to the strict requirements of electrical installation. It ensures error-free installation of cables and components, quickly and reliably. Now you can also lower installation expenses without compromising quality and safety: with protection against mismatching reduces the need for servicing and prevents unnecessary downtime.

- protection against mismatching eliminates errors
- pre-assembled versions
- with A coding for a great number of applications
- flexible installation to save space
- fast, secure installation

## Data

### Electrical data

#### Ratings per IEC/EN

Ratings per	IEC/EN 60664-1
Nominal voltage (III/3)	400 V
Rated impulse voltage (III/3)	6 kV
Rated current	25 A
Legend (ratings)	(III / 3) ≙ Overvoltage category III / Pollution degree 3

#### Ratings per UL 1977

Note for the US market	Some versions may also be used for current interruption in accordance with the UL certificate in select applications with currents below 16 A and voltages up to 600 V. For further information, please contact your local sales office.
Rated voltage (UL 1977)	600 V
Rated current UL 1977	23 A

### General information

Note on contact resistance	approx. 1 mΩ of contact resistance approx. 0.25 mΩ contact transition plug/socket
----------------------------	--

### Connection data

Connection points	8
Total number of potentials	4
PE function	Preceding PE contact

Subject to changes. Please also observe the further product documentation!



## Connection 1

Connection technology	Push-in CAGE CLAMP®
Actuation type	Operating tool Push-in
Nominal cross-section	4 mm <sup>2</sup> / 12 AWG
Solid conductor	0.5 ... 4 mm <sup>2</sup> / 20 ... 12 AWG
Solid conductor; push-in termination	1.5 ... 4 mm <sup>2</sup> / 16 ... 12 AWG
Stranded conductor	0.5 ... 2.5 mm <sup>2</sup> / 20 ... 14 AWG
Fine-stranded conductor	0.5 ... 4 mm <sup>2</sup> / 20 ... 12 AWG
Fine-stranded conductor; with insulated ferrule	0.25 ... 1.5 mm <sup>2</sup> / 20 ... 16 AWG
Fine-stranded conductor; with uninsulated ferrule	0.25 ... 2.5 mm <sup>2</sup> / 20 ... 14 AWG
Fine-stranded conductor; with ferrule; push-in termination	1.5 mm <sup>2</sup> / 16 AWG
Strip length	9 mm / 0.35 inches
Pole number	4
Conductor entry direction to mating direction	0°

## Physical data

Pin spacing	10 mm / 0.394 inches
Width	40 mm / 1.575 inches
Height	12.9 mm / 0.508 inches
Depth	37.5 mm / 1.476 inches

## Mechanical Data

Application	General mains applications
Coding	A
Variable coding	Yes
Marking	1/L' 2/L' $\perp$ N
Potential marking	1/L' 2/L' $\perp$ N
Mating force of a plug-in connection	approx. 20 ... 70 N (depending on pole number)
Retention force of a plug-in connection	Locked: > 80 N
Unmating force of a plug-in connection	Unlocked: approx. 20 ... 70 N (depending on pole number)
Number of mating cycles	200, without resistive load
Protection type	IP20; When mated and secured with a strain relief housing: IP2xC (These compact connectors are not designed for use in open, easily accessible areas!)

Subject to changes. Please also observe the further product documentation!



## Plug-in connection

Contact type (pluggable connector)	Male connector/plug
Connector (connection type)	for conductor
Mismating protection	Yes
Note on mismating protection	All WINSTA <sup>®</sup> components are 100% protected against mismating when: a.) plugging different numbers of poles b.) plugging while rotated 180 c.) plugging while laterally staggered d.) plugging one pole
Locking lever	Can be retrofitted
Locking of plug-in connection	locking lever
Note on locking system	All connectors for mounted installations (snap-in versions for lighting fixtures or devices, all types of PCB and distribution connectors) are factory-equipped with locking levers to ensure plugs and sockets are securely locked. Additional locking levers are only required for flying leads (plug/socket).

## Material data

Note (material data)	Information on material specifications can be found here
Color	white
Cover color	gray
Material group	I
Insulation material	Polyamide (PA66)
Flammability class per UL94	V0
Clamping spring material	Chrome-nickel spring steel (CrNi)
Contact material	Copper or copper alloy; surface-treated
Contact plating	Tin
Fire load	0.258 MJ
Weight	12.9 g

## Environmental requirements

Processing temperature	-5 ... +40 °C
Continuous operating temperature	-35 ... +85 °C
Note on continuous operating temperature	Insulating parts for temperatures ≤ 105 °C

Subject to changes. Please also observe the further product documentation!

WAGO GmbH & Co. KG  
Hansastr. 27  
32423 Minden  
Phone: +49571 887-0 | Fax: +49571 887-169  
Email: [info.de@wago.com](mailto:info.de@wago.com) | Web: [www.wago.com](http://www.wago.com)

Do you have any questions about our products?  
We are always happy to take your call at +49 (571) 887-44222.

## Commercial data





Product Group	20 (Winsta)
eCl@ss 10.0	27-44-06-05
eCl@ss 9.0	27-44-06-05
ETIM 8.0	EC002560
ETIM 7.0	EC002560
ECCN	NO DATA
PU (SPU)	50 pcs
Packaging type	box
Country of origin	DE
GTIN	4044918254595
Customs tariff number	85366990990

## Environmental Product Compliance

RoHS Compliance Status	Compliant, No Exemption
------------------------	-------------------------

## Approvals / Certificates

### General approvals

Logo	Approval	Additional Approval Text	Certificate name
	CCA DEKRA Certification B.V.	IEC 61535	NL -84761
	CCA DEKRA Certification B.V.	EN 61535	71- 123228
	cURus Underwriters Laboratories Inc.	UL 1977	E45171
	cURus Underwriters Laboratories Inc.	UL 1059	E 45172
	VDE VDE Prüf- und Zertifizierungsinstitut	EN 61984	40002889

## Declarations of conformity and manufacturer's declarations



Subject to changes. Please also observe the further product documentation!

WAGO GmbH & Co. KG  
 Hansastr. 27  
 32423 Minden  
 Phone: +49571 887-0 | Fax: +49571 887-169  
 Email: [info.de@wago.com](mailto:info.de@wago.com) | Web: [www.wago.com](http://www.wago.com)





Do you have any questions about our products?  
 We are always happy to take your call at +49 (571) 887-44222.

Logo	Approval	Additional Approval Text	Certificate name
	EU-Declaration of Conformity WAGO GmbH & Co. KG	-	-

#### Approvals for marine applications

Logo	Approval	Additional Approval Text	Certificate name
	ABS American Bureau of Shipping	-	19- HG1868589- PDA
	DNV GL Det Norske Veritas, Germanischer Lloyd	-	TAE00001Z6
	LR Lloyds Register	IEC 61984	LR22429487TA

#### Counterpart

	<b>Item no.770-124</b> Socket; with strain relief housing; 4-pole; Cod. A; 4,00 mm <sup>2</sup> ; white	<a href="http://www.wago.com/770-124">www.wago.com/770-124</a>
	<b>Item no.770-224</b> Socket; 4-pole; Cod. A; 4,00 mm <sup>2</sup> ; white	<a href="http://www.wago.com/770-224">www.wago.com/770-224</a>
	<b>Item no.770-6224</b> Linect® T-connector; 4-pole; Cod. A; 1 input; 2 outputs; white	<a href="http://www.wago.com/770-6224">www.wago.com/770-6224</a>
	<b>Item no.770-676</b> T-distribution connector; 4-pole; Cod. A; 1 input; 2 outputs; 2 locking levers; white	<a href="http://www.wago.com/770-676">www.wago.com/770-676</a>
	<b>Item no.770-677</b> T-distribution connector; 4-pole; Cod. A; 1 input; 2 outputs; 3 locking levers; for flying leads; white	<a href="http://www.wago.com/770-677">www.wago.com/770-677</a>





Subject to changes. Please also observe the further product documentation!

	<b>Item no.770-724</b> Snap-in socket; 4-pole; Cod. A; 4,00 mm <sup>2</sup> ; white	<a href="http://www.wago.com/770-724">www.wago.com/770-724</a>
	<b>Item no.770-724/009-000</b> Snap-in socket; with protruding mating face; 4-pole; Cod. A; 4,00 mm <sup>2</sup> ; white	<a href="http://www.wago.com/770-724/009-000">www.wago.com/770-724/009-000</a>
	<b>Item no.770-824</b> Socket for PCBs; straight; 4-pole; Cod. A; white	<a href="http://www.wago.com/770-824">www.wago.com/770-824</a>
	<b>Item no.770-824/011-000</b> Socket for PCBs; angled; 4-pole; Cod. A; white	<a href="http://www.wago.com/770-824/011-000">www.wago.com/770-824/011-000</a>
	<b>Item no.770-994</b> h-distribution connector; 4-pole; Cod. A; 1 input; 2 outputs; outputs on one side; 2 locking levers; white	<a href="http://www.wago.com/770-994">www.wago.com/770-994</a>
	<b>Item no.770-995</b> h-distribution connector; 4-pole; Cod. A; 1 input; 2 outputs; outputs on one side; 3 locking levers; for flying leads; white	<a href="http://www.wago.com/770-995">www.wago.com/770-995</a>
	<b>Item no.771-9994/006-102</b> pre-assembled interconnecting cable; Eca; Socket/plug; 4-pole; Cod. A; H05VV-F 4G 1.5 mm <sup>2</sup> ; 1 m; 1,50 mm <sup>2</sup> ; white	<a href="http://www.wago.com/771-9994/006-102">www.wago.com/771-9994/006-102</a>
	<b>Item no.771-9994/106-102</b> pre-assembled connecting cable; Eca; Socket/open-ended; 4-pole; Cod. A; H05VV-F 4G 1.5 mm <sup>2</sup> ; 1 m; 1,50 mm <sup>2</sup> ; white	<a href="http://www.wago.com/771-9994/106-102">www.wago.com/771-9994/106-102</a>

## Required accessories

### Locking levers

#### Locking system

	<b>Item no.: 770-121</b> Locking lever; for flying leads; for manual operation; white	<a href="http://www.wago.com/770-121">www.wago.com/770-121</a>
	<b>Item no.: 770-131</b> Locking lever; for flying leads; for tool operation; white	<a href="http://www.wago.com/770-131">www.wago.com/770-131</a>
	<b>Item no.: 770-101</b> Locking lever; for flying leads; for manual operation; black	<a href="http://www.wago.com/770-101">www.wago.com/770-101</a>
	<b>Item no.: 770-111</b> Locking lever; for flying leads; for tool operation; black	<a href="http://www.wago.com/770-111">www.wago.com/770-111</a>

### Strain relief

#### Strain relief housing

Subject to changes. Please also observe the further product documentation!



**Item no.: 770-504/023-000**  
Strain relief housing; 4-pole; for 2 cables; 5.0 ... 9.0 mm; 55 mm; black

[www.wago.com/770-504/023-000](http://www.wago.com/770-504/023-000)



**Item no.: 770-514**  
Strain relief housing; 4-pole; for 2 cables; 9.0 ... 13.0 mm; 55 mm; white

[www.wago.com/770-514](http://www.wago.com/770-514)



**Item no.: 770-504**  
Strain relief housing; 4-pole; for 2 cables; 9.0 ... 13.0 mm; 55 mm; black

[www.wago.com/770-504](http://www.wago.com/770-504)



**Item no.: 770-514/023-000**  
Strain relief housing; 4-pole; for 2 cables; 5.0 ... 9.0 mm; 55 mm; white

[www.wago.com/770-514/023-000](http://www.wago.com/770-514/023-000)

## Optional accessories

### Cover

#### Cover



**Item no.: 770-360**  
Lockout cap; for plugs; 5-pole; separable; yellow

[www.wago.com/770-360](http://www.wago.com/770-360)



**Item no.: 897-2005**  
Protective cap; Type4; for sockets and plugs; PVC; red

[www.wago.com/897-2005](http://www.wago.com/897-2005)

### Tool

#### Operating tool



**Item no.: 210-719**  
Operating tool; Blade: 2.5 x 0.4 mm; with a partially insulated shaft

[www.wago.com/210-719](http://www.wago.com/210-719)

## Marking accessories

### Marker



**Item no.: 770-450/000-002**  
Marker card; Plastic; yellow

[www.wago.com/770-450/000-002](http://www.wago.com/770-450/000-002)



**Item no.: 770-450/000-001**  
Marker card; Plastic; green

[www.wago.com/770-450/000-001](http://www.wago.com/770-450/000-001)



**Item no.: 770-450/000-005**  
Marker card; Plastic; red

[www.wago.com/770-450/000-005](http://www.wago.com/770-450/000-005)



**Item no.: 770-450**  
Marker card; Plastic; white

[www.wago.com/770-450](http://www.wago.com/770-450)

Subject to changes. Please also observe the further product documentation!





Item no.: 770-450/000-006  
Marker card; Plastic; blue

[www.wago.com/770-450/000-006](http://www.wago.com/770-450/000-006)



Item no.: 770-450/000-012  
Marker card; Plastic; orange

[www.wago.com/770-450/000-012](http://www.wago.com/770-450/000-012)

### Strain relief

Strain relief housing



Item no.: 770-504/020-000  
Strain relief housing; 4-pole; for 1 cable; 11.5 ... 16.5 mm; 71 mm; black

[www.wago.com/770-504/020-000](http://www.wago.com/770-504/020-000)

### Mounting

Mounting accessories



Item no.: 770-319  
Snap-in frame; 4-pole; 1.0 ... 3.0 mm; black

[www.wago.com/770-319](http://www.wago.com/770-319)



Item no.: 770-339  
Snap-in frame; 4-pole; 1.0 ... 3.0 mm; white

[www.wago.com/770-339](http://www.wago.com/770-339)

## Downloads

### Documentation

#### Bid Text

770-234 X81 - Datei	2019 Feb 19	xml 3.0 kB	Download
770-234 doc - Datei	2015 Jun 8	doc 24.1 kB	Download

### CAD/CAE-Data

#### CAD data

2D/3D Models 770-234	URL	Download
----------------------	-----	----------

#### CAE data

EPLAN Data Portal 770-234	URL	Download
---------------------------	-----	----------

WSCAD Universe 770-234	URL	Download
------------------------	-----	----------

Subject to changes. Please also observe the further product documentation!

WAGO GmbH & Co. KG  
Hansastr. 27  
32423 Minden  
Phone: +49571 887-0 | Fax: +49571 887-169  
Email: [info.de@wago.com](mailto:info.de@wago.com) | Web: [www.wago.com](http://www.wago.com)

Do you have any questions about our products?  
We are always happy to take your call at +49 (571) 887-44222.

ZUKEN Portal 770-234

[URL](#)

[Download](#)

### Asset Administration Shell

Asset Administration Shell 770-234

[URL](#)

[Download](#)

## Environmental Product Compliance

### Compliance Search

Environmental Product Compliance 770-234

[URL](#)

[Download](#)

Plug; 4-pole; Cod. A; 4,00 mm<sup>2</sup>; white

## Installation Notes

### Conductor termination

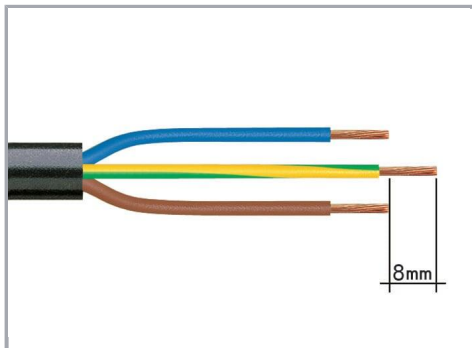

1. Strip length, outer insulation = 35 mm (2-pole), 55 mm (3- to 5-pole)
2. Strip length = 9 mm
3. Extended ground conductor = 8 mm

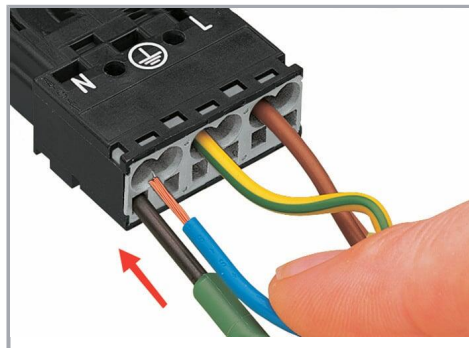

To terminate fine-stranded conductors, open the clamping unit via screwdriver (2.5 mm blade width) and insert a stripped conductor until it hits the backstop.

Subject to changes. Please also observe the further product documentation!

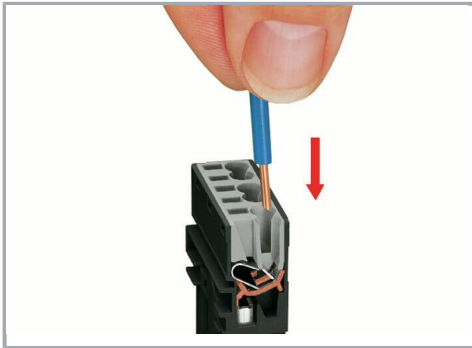

Insert the stripped solid conductor until it hits the backstop.

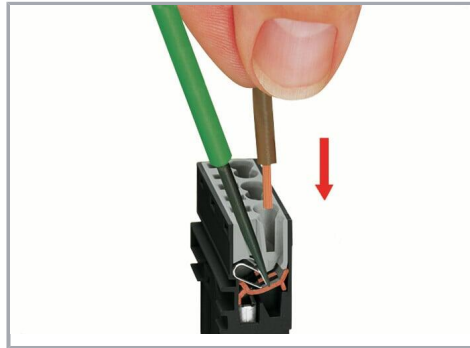

To terminate fine-stranded conductors, open the clamping unit via screwdriver (2.5 mm blade width) and insert a stripped conductor until it hits the backstop.

#### Conductor removal

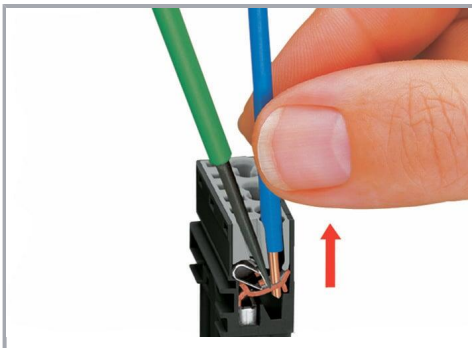

To remove the conductor, actuate the clamp via screwdriver (2.5 mm blade width) and pull out the conductor.

#### Installation

Subject to changes. Please also observe the further product documentation!

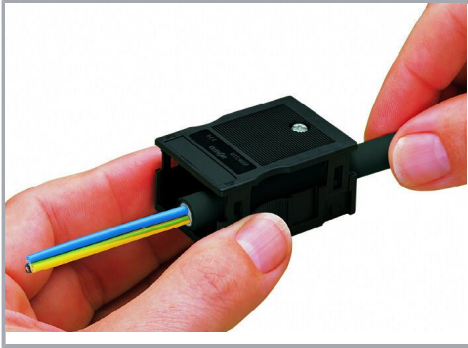

We recommend pulling the pre-latched strain relief housing over the cable prior to termination. However, the strain relief can be mounted at a later time as well.

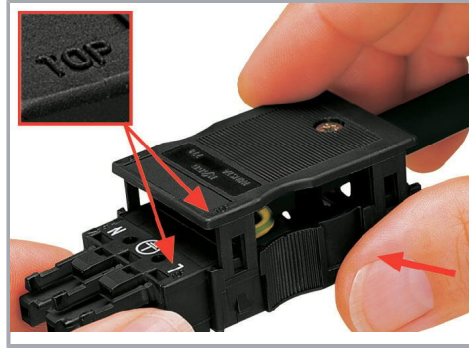

Latch the strain relief housing onto the plug /socket. Note the "TOP" inscription.

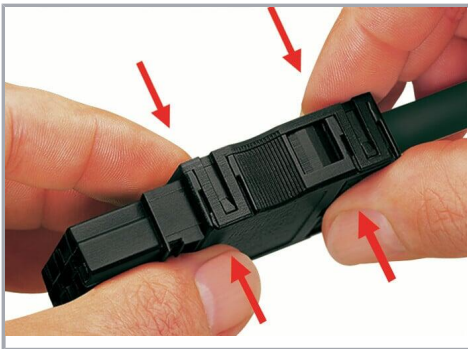

Prepare strain relief housing by snapping together upper and bottom part.



Tighten strain relief screw with screwdriver (2.5 mm blade width).

## Product family

WINSTA® MIDI

[Show all products from the family](#)

Subject to changes. Please also observe the further product documentation!