

Data sheet | Item number: 713-1108/037-047/033-000

1-conductor female connector, 2-row; CAGE CLAMP®; 1.5 mm²; Pin spacing 3.5 mm; 16-pole; 100% protected against mismatching; Levers; Strain relief plate; direct marking; 1,50 mm²; black



www.wago.com/713-1108/037-047/033-000



i Picture differs from the item.

Color:

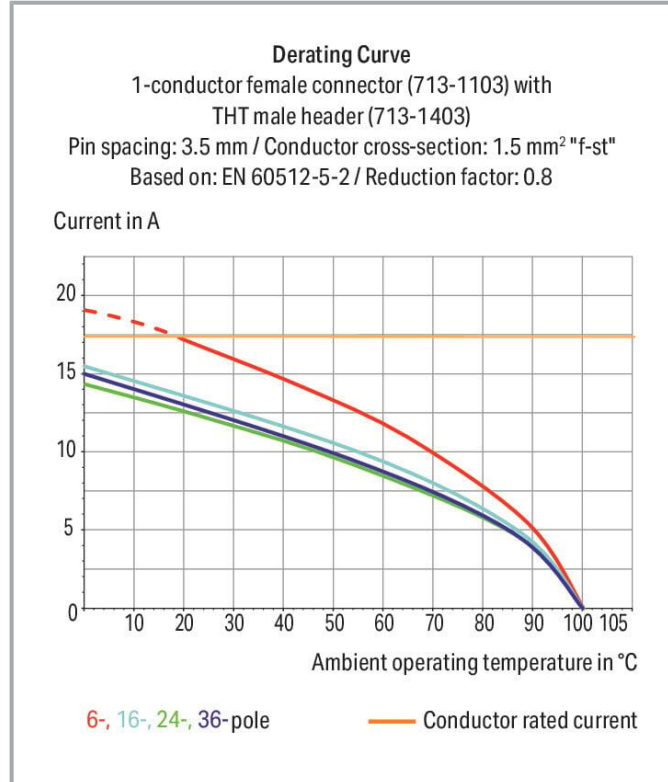

Subject to changes. Please also observe the further product documentation!

WAGO GmbH & Co. KG
Hansastr. 27
32423 Minden
Phone: +49571 887-0 | Fax: +49571 887-169
Email: info.de@wago.com | Web: www.wago.com

Do you have any questions about our products?
We are always happy to take your call at +49 (571) 887-44222.

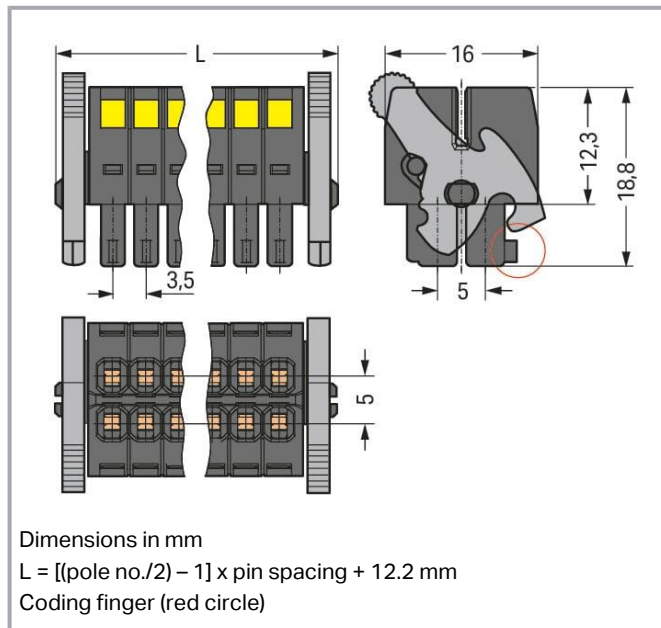

Item description

- Universal connection for all conductor types
- Unique, compact, double-row connector system for conductor cross-sections up to 1.5 mm²
- High-density, wire-to-board connections in very confined spaces
- Centered strain relief plate anchors conductors, while acting as convenient connection and disconnection handle. It also provides easy access to operating slots – even when wired.
- Coding fingers provide 100% protection against mismatching

Data

Notes

Safety information

The *MCS – MULTI CONNECTION SYSTEM* includes connectors without breaking capacity in accordance with DIN EN 61984. When used as intended, these connectors must not be connected /disconnected when live or under load. When used as intended, these connectors must not be connected/disconnected when live or under load. The circuit design should ensure header pins, which can be touched, are not live when unmated.

Variants:

Other pole numbers
 Gold-plated or partially gold-plated contact surfaces
 Other versions (or variants) can be requested from WAGO Sales or configured at <https://configurator.wago.com/>.

Subject to changes. Please also observe the further product documentation!

WAGO GmbH & Co. KG

Hansastr. 27

32423 Minden

Phone: +49571 887-0 | Fax: +49571 887-169

Email: info.de@wago.com | Web: www.wago.com

Do you have any questions about our products?

We are always happy to take your call at +49 (571) 887-44222.



Electrical data

Ratings per IEC/EN

| Ratings per | IEC/EN 60664-1 |
|-------------------------------|---|
| Nominal voltage (III/3) | 80 V |
| Rated impulse voltage (III/3) | 2.5 kV |
| Rated voltage (III/2) | 160 V |
| Rated impulse voltage (III/2) | 2.5 kV |
| Nominal voltage (II/2) | 250 V |
| Rated surge voltage (II/2) | 2.5 kV |
| Rated current | 10 A |
| Legend (ratings) | (III / 2) $\hat{=}$ Overvoltage category III / Pollution degree 2 |

Ratings per UL

| Approvals per | UL 1059 |
|--------------------------------|---------|
| Rated voltage UL (Use Group B) | 300 V |
| Rated current UL (Use Group B) | 10 A |
| Rated voltage UL (Use Group C) | 50 V |
| Rated current UL (Use Group C) | 10 A |

Ratings per CSA

| Approvals per | CSA |
|---------------------------------|-------|
| Rated voltage CSA (Use Group B) | 300 V |
| Rated current CSA (Use Group B) | 10 A |

Connection data

| | |
|----------------------------|----|
| Connection points | 16 |
| Total number of potentials | 16 |
| Number of connection types | 1 |
| Number of levels | 2 |

Connection 1

| | |
|-----------------------|--|
| Connection technology | CAGE CLAMP [®] |
| Actuation type | Operating tool |
| Actuation direction 1 | Operation perpendicular to conductor entry |
| Solid conductor | 0.08 ... 1.5 mm ² / 28 ... 16 AWG |

Subject to changes. Please also observe the further product documentation!



| | |
|---|--|
| Fine-stranded conductor | 0.08 ... 1.5 mm ² / 28 ... 16 AWG |
| Fine-stranded conductor; with insulated ferrule | 0.25 ... 1 mm ² |
| Fine-stranded conductor; with uninsulated ferrule | 0.25 ... 1 mm ² |
| Strip length | 6 ... 7 mm / 0.24 ... 0.28 inches |
| Pole number | 16 |
| Conductor entry direction to mating direction | 0° |

Physical data

| | |
|-------------|------------------------|
| Pin spacing | 3.5 mm / 0.138 inches |
| Width | 36.5 mm / 1.437 inches |
| Height | 43.7 mm / 1.72 inches |
| Depth | 16 mm / 0.63 inches |

Mechanical Data

| | |
|--------------------------|-----|
| Variable coding | Yes |
| Anti-rotation protection | Yes |

Plug-in connection

| | |
|--------------------------------------|-------------------------|
| Contact type (pluggable connector) | Female connector/socket |
| Connector (connection type) | for conductor |
| Mismating protection | Yes |
| Plugging without loss of pin spacing | No |
| Locking of plug-in connection | Locking lever |
| Strain relief | strain relief plate |

Material data

| | |
|-----------------------------|--|
| Note (material data) | Information on material specifications can be found here |
| Color | black |
| Material group | II |
| Insulation material | Glass fiber-reinforced polyamide (PA66 GF) |
| Flammability class per UL94 | V0 |
| Clamping spring material | Chrome-nickel spring steel (CrNi) |
| Contact material | Copper alloy |
| Contact plating | Tin |
| Fire load | 0.151 MJ |

Subject to changes. Please also observe the further product documentation!



| | |
|--------|------|
| Weight | 10 g |
|--------|------|

Environmental requirements

| | |
|-------------------------|-----------------|
| Limit temperature range | -60 ... +100 °C |
| Processing temperature | -35 ... +60 °C |

Commercial data

| | |
|-----------------------|------------------------|
| Product Group | 3 (Multi Conn. System) |
| eCl@ss 10.0 | 27-14-11-06 |
| eCl@ss 9.0 | 27-14-11-06 |
| ETIM 8.0 | EC001284 |
| ETIM 7.0 | EC001284 |
| ECCN | NO DATA |
| PU (SPU) | 25 pcs |
| Packaging type | box |
| Country of origin | PL |
| GTIN | 4050821177395 |
| Customs tariff number | 85366990990 |

Environmental Product Compliance

| | |
|-------------------------------------|--|
| CAS-No. | 131651-65-5 144317-44-2 220133-51-7 220689-12-3 25628-08-4 29420-49-3 375-73-5 503155-89-3 507453-86-3 68259-10-9 |
| REACH Candidate List Substance | Perfluorobutane sulfonic acid (PFBS) and its salts |
| RoHS Compliance Status | Compliant,With Exemption |
| RoHS Exemption | 6(c) 7(a) 7(c)-I 7(c)-II |
| SCIP notification number (Austria) | 4aaf3dc0-174a-415b-8eb1-7e72331f4480 |
| SCIP notification number (Belgium) | bc5a7c3b-3ac6-4453-8701-e800b0039804 |
| SCIP notification number (Bulgaria) | 4143d8c6-d0a9-4e04-b55f-f321be2e0df7 |

Subject to changes. Please also observe the further product documentation!



WAGO GmbH & Co. KG
Hansastr. 27
32423 Minden
Phone: +49571 887-0 | Fax: +49571 887-169
Email: info.de@wago.com | Web: www.wago.com

Do you have any questions about our products?
We are always happy to take your call at +49 (571) 887-44222.

| | |
|---|--------------------------------------|
| SCIP notification number (Czech Republic) | d534dd04-2009-44bb-8b6f-8381f32c661a |
| SCIP notification number (Denmark) | 6c9d554d-3c82-478f-8b79-98f60f17fd0d |
| SCIP notification number (Finland) | 0e8403e2-23ee-4c68-a737-572277d21e6b |
| SCIP notification number (France) | 5902a903-6ed7-4535-a747-7b6131d95f07 |
| SCIP notification number (Germany) | fb1e3dbe-04b6-47fa-ae2a-6f9902233ca3 |
| SCIP notification number (Hungary) | c84a48d9-9630-41df-a201-8b9c0aea7457 |
| SCIP notification number (Italy) | 97814517-42c6-4797-882e-4ad0cc0cd6fd |
| SCIP notification number (Netherlands) | 55ca3c45-461b-495a-9669-8bb83081efd7 |
| SCIP notification number (Poland) | ae3308f5-673e-4f59-b924-a6157b507dc9 |
| SCIP notification number (Romania) | 276d7e5e-4bb9-4685-b8c3-7b1ac385fca1 |
| SCIP notification number (Sweden) | d6831d6a-ff57-4279-870f-d3d571992a2e |

Approvals / Certificates

General approvals

| Logo | Approval | Additional Approval Text | Certificate name |
|--|---------------------------------------|--------------------------|------------------|
|  | CSA CSA Group | C22.2 | 2315087 |
|  | KEMA/KEUR DEKRA Certification B.V. | EN 61984 | 71- 126089 |
|  | UR Underwriters Laboratories Inc. | UL 1059 | E45172 |

Counterpart



Item no.713-1428/037-000

THT male header, 2-row; 0.8 x 0.8 mm solder pin; angled; 100% protected against mismatching; Levers; Pin spacing 3.5 mm; 16-pole; black

www.wago.com/713-1428/037-000



Item no.713-1408/037-000

THT male header, 2-row; 0.8 x 0.8 mm solder pin; straight; 100% protected against mismatching; Levers; Pin spacing 3.5 mm; 16-pole; black

www.wago.com/713-1408/037-000

Optional accessories

Strain relief

Subject to changes. Please also observe the further product documentation!

WAGO GmbH & Co. KG

Hansastr. 27

32423 Minden

Phone: +49571 887-0 | Fax: +49571 887-169

Email: info.de@wago.com | Web: www.wago.com

Do you have any questions about our products?

We are always happy to take your call at +49 (571) 887-44222.

Strain relief plate















**Item no.: 713-127**

Strain relief plate; for female connectors; 25 mm wide; 1 part; Pin spacing 3.5 mm; black

www.wago.com/713-127

Ferrule

Ferrule

| | | |
|---|--|--|
|  | Item no.: 216-101 Ferrule; Sleeve for 0.5 mm ² / AWG 22; uninsulated; electro-tin plated; silver-colored | www.wago.com/216-101 |
|  | Item no.: 216-102 Ferrule; Sleeve for 0.75 mm ² / AWG 20; uninsulated; electro-tin plated; silver-colored | www.wago.com/216-102 |
|  | Item no.: 216-103 Ferrule; Sleeve for 1 mm ² / AWG 18; uninsulated; electro-tin plated | www.wago.com/216-103 |
|  | Item no.: 216-123 Ferrule; Sleeve for 1 mm ² / AWG 18; uninsulated; electro-tin plated; silver-colored | www.wago.com/216-123 |
|  | Item no.: 216-122 Ferrule; Sleeve for 0.75 mm ² / AWG 20; uninsulated; electro-tin plated; silver-colored | www.wago.com/216-122 |
|  | Item no.: 216-142 Ferrule; Sleeve for 0.75 mm ² / 18 AWG; uninsulated; electro-tin plated; electrolytic copper; gastight crimped; acc. to DIN 46228, Part 1/08.92 | www.wago.com/216-142 |
|  | Item no.: 216-132 Ferrule; Sleeve for 0.34 mm ² / AWG 24; uninsulated; electro-tin plated | www.wago.com/216-132 |
|  | Item no.: 216-121 Ferrule; Sleeve for 0.5 mm ² / AWG 22; uninsulated; electro-tin plated; silver-colored | www.wago.com/216-121 |
|  | Item no.: 216-143 Ferrule; Sleeve for 1 mm ² / AWG 18; uninsulated; electro-tin plated; electrolytic copper; gastight crimped; acc. to DIN 46228, Part 1/08.92 | www.wago.com/216-143 |
|  | Item no.: 216-131 Ferrule; Sleeve for 0.25 mm ² / AWG 24; uninsulated; electro-tin plated; silver-colored | www.wago.com/216-131 |
|  | Item no.: 216-141 Ferrule; Sleeve for 0.5 mm ² / 20 AWG; uninsulated; electro-tin plated; electrolytic copper; gastight crimped; acc. to DIN 46228, Part 1/08.92 | www.wago.com/216-141 |
|  | Item no.: 216-152 Ferrule; Sleeve for 0.34 mm ² / AWG 24; uninsulated; electro-tin plated | www.wago.com/216-152 |
|  | Item no.: 216-203 Ferrule; Sleeve for 1 mm ² / AWG 18; insulated; electro-tin plated; red | www.wago.com/216-203 |
|  | Item no.: 216-202 Ferrule; Sleeve for 0.75 mm ² / 18 AWG; insulated; electro-tin plated; gray | www.wago.com/216-202 |
|  | Item no.: 216-151 Ferrule; Sleeve for 0.25 mm ² / AWG 24; uninsulated; electro-tin plated | www.wago.com/216-151 |

Subject to changes. Please also observe the further product documentation!

WAGO GmbH & Co. KG

Hansastr. 27



32423 Minden

Phone: +49571 887-0 | Fax: +49571 887-169



Email: info.de@wago.com | Web: www.wago.com

Do you have any questions about our products?

We are always happy to take your call at +49 (571) 887-44222.

| | | |
|---|--|--|
|  | Item no.: 216-201 Ferrule; Sleeve for 0.5 mm ² / 20 AWG; insulated; electro-tin plated; white | www.wago.com/216-201 |
|  | Item no.: 216-223 Ferrule; Sleeve for 1 mm ² / AWG 18; insulated; electro-tin plated; red | www.wago.com/216-223 |
|  | Item no.: 216-241 Ferrule; Sleeve for 0.5 mm ² / 20 AWG; insulated; electro-tin plated; electrolytic copper; gastight crimped; acc. to DIN 46228, Part 4/09.90; white | www.wago.com/216-241 |
|  | Item no.: 216-242 Ferrule; Sleeve for 0.75 mm ² / 18 AWG; insulated; electro-tin plated; electrolytic copper; gastight crimped; acc. to DIN 46228, Part 4/09.90; gray | www.wago.com/216-242 |
|  | Item no.: 216-222 Ferrule; Sleeve for 0.75 mm ² / 18 AWG; insulated; electro-tin plated; gray | www.wago.com/216-222 |
|  | Item no.: 216-221 Ferrule; Sleeve for 0.5 mm ² / 20 AWG; insulated; electro-tin plated; white | www.wago.com/216-221 |
|  | Item no.: 216-243 Ferrule; Sleeve for 1 mm ² / AWG 18; insulated; electro-tin plated; electrolytic copper; gastight crimped; acc. to DIN 46228, Part 4/09.90; red | www.wago.com/216-243 |
|  | Item no.: 216-263 Ferrule; Sleeve for 1 mm ² / AWG 18; insulated; electro-tin plated; electrolytic copper; gastight crimped; acc. to DIN 46228, Part 4/09.90; red | www.wago.com/216-263 |
|  | Item no.: 216-262 Ferrule; Sleeve for 0.75 mm ² / 18 AWG; insulated; electro-tin plated; electrolytic copper; gastight crimped; acc. to DIN 46228, Part 4/09.90; gray | www.wago.com/216-262 |
|  | Item no.: 216-301 Ferrule; Sleeve for 0.25 mm ² / AWG 24; insulated; electro-tin plated; yellow | www.wago.com/216-301 |
|  | Item no.: 216-321 Ferrule; Sleeve for 0.25 mm ² / AWG 24; insulated; electro-tin plated; yellow | www.wago.com/216-321 |
|  | Item no.: 216-322 Ferrule; Sleeve for 0.34 mm ² / 22 AWG; insulated; electro-tin plated; light turquoise | www.wago.com/216-322 |
|  | Item no.: 216-302 Ferrule; Sleeve for 0.34 mm ² / 22 AWG; insulated; electro-tin plated; light turquoise | www.wago.com/216-302 |

Tool

| | | |
|--|--|--|
| Operating tool | | |
|  | Item no.: 210-647 Operating tool; Blade: 2.5 x 0.4 mm; with a partially insulated shaft; multicoloured | www.wago.com/210-647 |
|  | Item no.: 210-719 Operating tool; Blade: 2.5 x 0.4 mm; with a partially insulated shaft | www.wago.com/210-719 |

Subject to changes. Please also observe the further product documentation!

Downloads

Documentation

Additional Information

| | | | |
|------------------------|------------|--------|----------|
| Technical Section | 2019 Apr 3 | pdf | Download |
| Technical explanations | | 2.1 MB | |

Environmental Product Compliance

Compliance Search

| | | |
|--|-----|----------|
| Environmental Product Compliance 713-1108/037-047/033-000 | URL | Download |
| 1-conductor female connector, 2-row; CAGE CLAMP®; 1.5 mm ² ; Pin spacing 3.5 mm; 16-pole; 100% protected against mismatching; Levers; Strain relief plate; direct marking; 1,50 mm ² ; black | | |

Installation Notes

Conductor termination

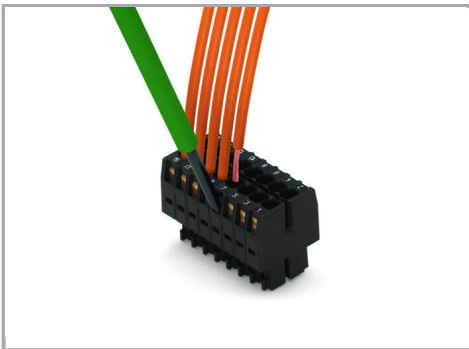

Inserting a conductor via (2.5 x 0.4) mm screwdriver.

Locking system

Subject to changes. Please also observe the further product documentation!

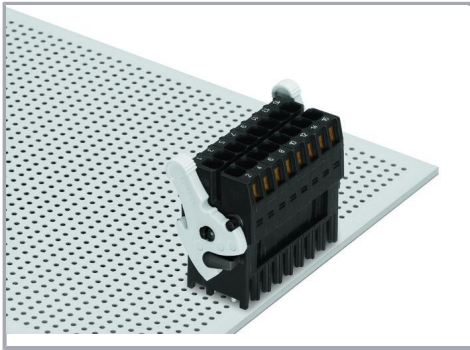

Lever as a lock – when closed, female connector is locked.

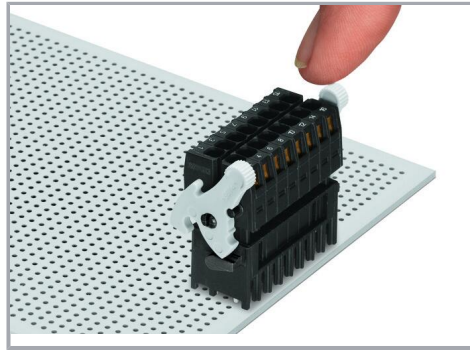

Lever as a disconnection aid – when opened, female connector is disconnected. Rotating the lever lifts the female connector out of the male header.

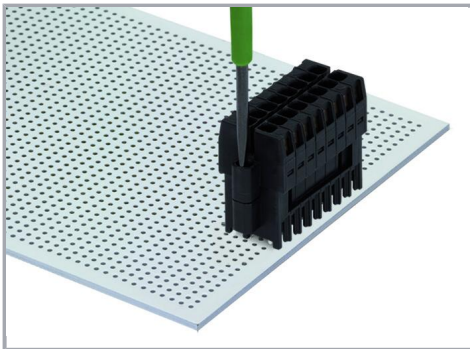

Screw interlock can only be disconnected using a tool.

Coding

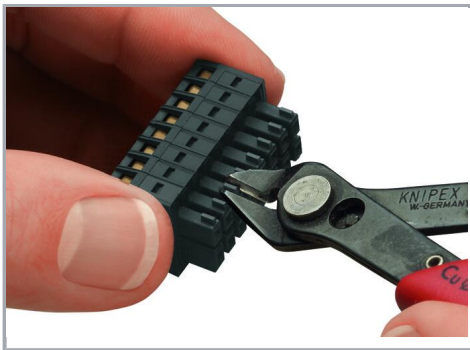

Coding a female connector by removing coding finger(s).

Strain relief

Subject to changes. Please also observe the further product documentation!

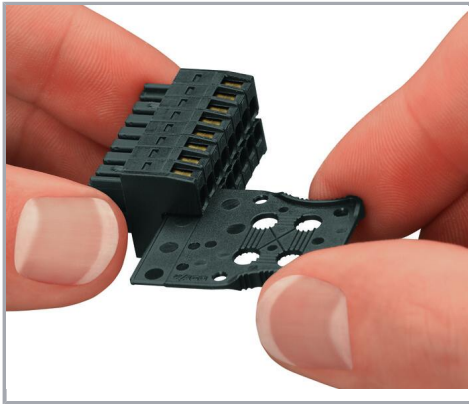

Strain relief plate for field assembly

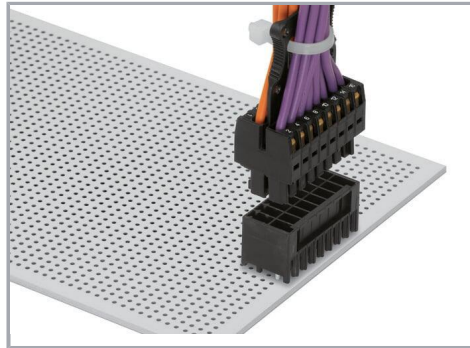

Centered strain relief plate anchors conductors for easy disconnection.

Product family

MCS MINI HD

[Show all products from the family](#)

Subject to changes. Please also observe the further product documentation!