

Data sheet | Item number: 769-107/000-036

1-conductor female connector; CAGE CLAMP®; 4 mm²; Pin spacing 5 mm; 7-pole; coding finger; 4,00 mm²; green-yellow/gray

www.wago.com/769-107/000-036

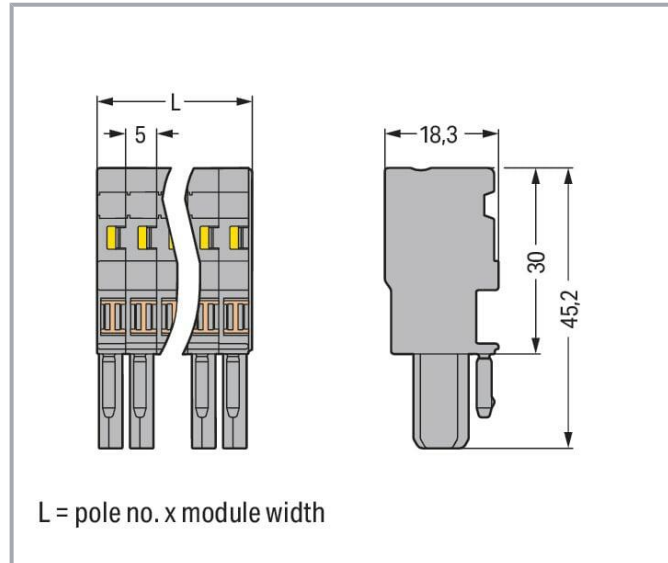
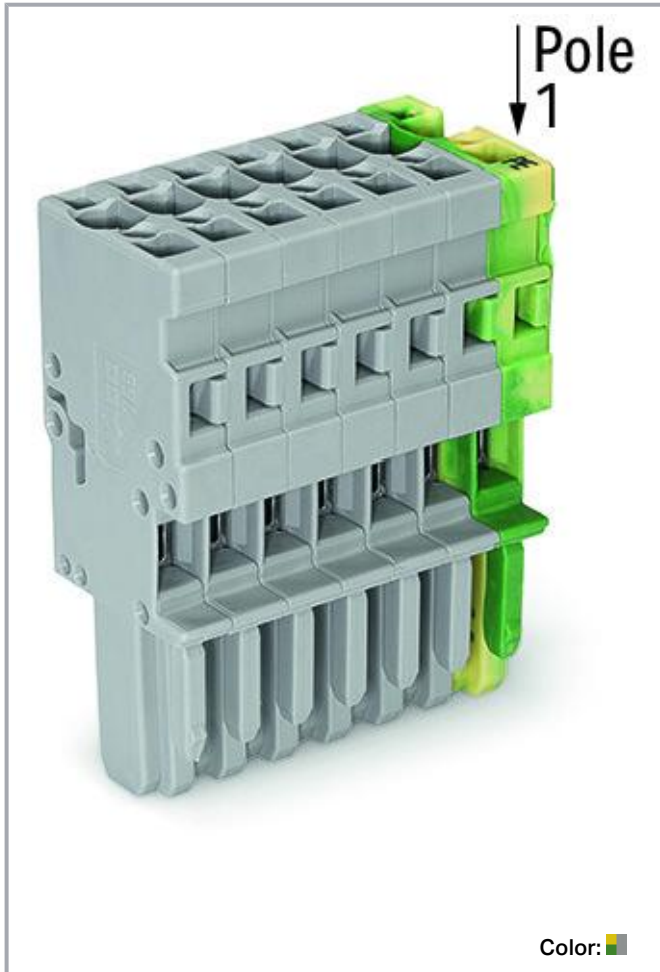

Data

Notes

Safety information

According to EN 61984, pluggable connectors without current interrupting capacity must not be mated or unmated when live or under load.

Electrical data

Subject to changes. Please also observe the further product documentation!

WAGO GmbH & Co. KG
Hansastr. 27
32423 Minden
Phone: +49571 887-0 | Fax: +49571 887-169
Email: info.de@wago.com | Web: www.wago.com

Do you have any questions about our products?
We are always happy to take your call at +49 (571) 887-44222.



Ratings per IEC/EN

Ratings per	IEC/EN 61984
Nominal voltage (III/3)	500 V
Rated impulse voltage (III/3)	6 kV
Rated current	32 A
Legend (ratings)	(III / 3) ≙ Overvoltage category III / Pollution degree 3

Connection data

Connection points	7
Total number of potentials	7

Connection 1

Connection technology	CAGE CLAMP®
Actuation type	Operating tool
Connectable conductor materials	Copper
Nominal cross-section	4 mm ² / 12 AWG
Solid conductor	0.08 ... 4 mm ² / 28 ... 12 AWG
Fine-stranded conductor	0.08 ... 4 mm ² / 28 ... 12 AWG
Strip length	8 ... 9 mm / 0.31 ... 0.35 inches
Pole number	7
Wiring direction	Front-entry wiring

Physical data

Width	35 mm / 1.378 inches
Height	45.2 mm / 1.78 inches
Depth	18.3 mm / 0.72 inches
Module width	5 mm / 0.197 inches

Mechanical Data

Variable coding	Yes
Direct ground contact to DIN-rail/drilled hole/housing	No
Marking level	Side marking
Anti-rotation protection	Yes

Subject to changes. Please also observe the further product documentation!

WAGO GmbH & Co. KG
 Hansastr. 27
 32423 Minden
 Phone: +49571 887-0 | Fax: +49571 887-169
 Email: info.de@wago.com | Web: www.wago.com

Do you have any questions about our products?
 We are always happy to take your call at +49 (571) 887-44222.

Plug-in connection

Contact type (pluggable connector)	Female connector/socket
Connector (connection type)	for conductor
Mismatching protection	No
Plugging without loss of pin spacing	Yes

Material data

Note (material data)	Information on material specifications can be found here
Color	green-yellow/gray
Material group	I
Insulation material	Polyamide (PA66)
Flammability class per UL94	V0
Fire load	0.426 MJ
Halogen-free	Yes
Weight	22.1 g

Environmental requirements

Processing temperature	-35 ... +85 °C
Continuous operating temperature	-60 ... +105 °C

Commercial data

eCl@ss 10.0	27-14-11-06
eCl@ss 9.0	27-14-11-06
ETIM 8.0	EC001284
ETIM 7.0	EC001284
ECCN	NO DATA
PU (SPU)	25 pcs
Packaging type	box
Country of origin	DE
GTIN	4045454211004
Customs tariff number	85366990990

Subject to changes. Please also observe the further product documentation!



Environmental Product Compliance

RoHS Compliance Status

Compliant, No Exemption

Approvals / Certificates



General approvals

Logo	Approval	Additional Approval Text	Certificate name
	CSA CSA Group	C22.2	1101144
	UL Underwriters Laboratories Inc.	UL 1977	E 45171
	UR Underwriters Laboratories Inc.	UL 1059	E45172



Optional accessories

Marking accessories

Marking strip

	Item no.: 210-831 Marking strips; on reel; 2.3 mm wide; plain; Self-adhesive; white	www.wago.com/210-831
	Item no.: 210-834 Marking strips; on reel; 5 mm wide; plain; Self-adhesive; white	www.wago.com/210-834
	Item no.: 210-832 Marking strips; on reel; 3 mm wide; plain; Self-adhesive; white	www.wago.com/210-832

Label

	Item no.: 210-805 Labels; for Smart Printer; permanent adhesive; 6 x 15 mm; white	www.wago.com/210-805
	Item no.: 210-805/000-002 Labels; for Smart Printer; permanent adhesive; 6 x 15 mm; yellow	www.wago.com/210-805/000-002

Subject to changes. Please also observe the further product documentation!

WAGO GmbH & Co. KG

Hansastr. 27

32423 Minden

Phone: +49571 887-0 | Fax: +49571 887-169

Email: info.de@wago.com | Web: www.wago.com

Do you have any questions about our products?

We are always happy to take your call at +49 (571) 887-44222.

Marker



Item no.: 2009-145

Mini-WSB Inline; for Smart Printer; 1700 pieces on roll; stretchable 5 - 5.2 mm; plain; snap-on type; white

www.wago.com/2009-145



Item no.: 248-501

Mini-WSB marking card; as card; not stretchable; plain; snap-on type; white

www.wago.com/248-501

Insulation stop

Insulation stop



Item no.: 769-470

Insulation stop; 0.08 - 0.2 mm² "s" (0.14 mm² "f-st"); 5 pieces/strip; white

www.wago.com/769-470



Item no.: 769-471

Insulation stop; 0.25 - 0.5 mm²; 5 pieces/strip; light gray

www.wago.com/769-471



Item no.: 769-472

Insulation stop; 0.75 - 1 mm²; 5 pieces/strip; dark gray

www.wago.com/769-472

Testing and measuring

Testing accessories



Item no.: 210-136

Test plug; 2 mm Ø; with 500 mm cable; red

www.wago.com/210-136

Locking levers

Locking system



Item no.: 769-430

Locking lever; for female connectors; 1 part; Pin spacing 5 mm; 2-pole; gray

www.wago.com/769-430



Item no.: 769-431

Locking lever; for female connectors; 1 part; Pin spacing 5 mm; 2-pole; orange

www.wago.com/769-431

Cover

Cover



Item no.: 769-436

Jumper cover; for 1-conductor female plugs; for 5 poles; gray

www.wago.com/769-436

Jumpers

Jumper



Item no.: 769-402

Jumper; insulated; gray

www.wago.com/769-402

Tool

Operating tool

Subject to changes. Please also observe the further product documentation!

WAGO GmbH & Co. KG

Hansastr. 27















32423 Minden

Phone: +49571 887-0 | Fax: +49571 887-169

Email: info.de@wago.com | Web: www.wago.com

Do you have any questions about our products?

We are always happy to take your call at +49 (571) 887-44222.

	Item no.: 210-490 Operating tool	www.wago.com/210-490
	Item no.: 769-434 Operating tool; made of insulating material; 1-way; loose; white	www.wago.com/769-434
Protective warning marker		
Cover		
	Item no.: 280-415 Protective warning marker; for 5 terminal blocks; with high-voltage symbol, black; yellow	www.wago.com/280-415
Strain relief		
Strain relief		
	Item no.: 769-1607 Strain relief housing; for female and male connectors; 2 parts; Pin spacing 5 mm; 7-pole; gray	www.wago.com/769-1607
	Item no.: 769-413 Strain relief plate; for female and male connectors; 1 part; Pin spacing 5 mm; 6- to 9-pole; gray	www.wago.com/769-413
Ferrule		
Ferrule		
	Item no.: 216-101 Ferrule; Sleeve for 0.5 mm ² / AWG 22; uninsulated; electro-tin plated; silver-colored	www.wago.com/216-101
	Item no.: 216-104 Ferrule; Sleeve for 1.5 mm ² / AWG 16; uninsulated; electro-tin plated; silver-colored	www.wago.com/216-104
	Item no.: 216-102 Ferrule; Sleeve for 0.75 mm ² / AWG 20; uninsulated; electro-tin plated; silver-colored	www.wago.com/216-102
	Item no.: 216-103 Ferrule; Sleeve for 1 mm ² / AWG 18; uninsulated; electro-tin plated	www.wago.com/216-103
	Item no.: 216-203 Ferrule; Sleeve for 1 mm ² / AWG 18; insulated; electro-tin plated; red	www.wago.com/216-203
	Item no.: 216-206 Ferrule; Sleeve for 2.5 mm ² / AWG 14; insulated; electro-tin plated; blue	www.wago.com/216-206
	Item no.: 216-202 Ferrule; Sleeve for 0.75 mm ² / 18 AWG; insulated; electro-tin plated; gray	www.wago.com/216-202
	Item no.: 216-204 Ferrule; Sleeve for 1.5 mm ² / AWG 16; insulated; electro-tin plated; black	www.wago.com/216-204
	Item no.: 216-201 Ferrule; Sleeve for 0.5 mm ² / 20 AWG; insulated; electro-tin plated; white	www.wago.com/216-201
	Item no.: 216-301 Ferrule; Sleeve for 0.25 mm ² / AWG 24; insulated; electro-tin plated; yellow	www.wago.com/216-301

Subject to changes. Please also observe the further product documentation!

Item no.: 216-302

Ferrule; Sleeve for 0.34 mm² / 22 AWG; insulated; electro-tin plated; light turquoisewww.wago.com/216-302**Downloads****Documentation****Bid Text**

769-107/000-036 X81 - Datei	2019 Feb 19	xml 3.3 kB	Download
769-107/000-036 doc - Datei	2017 Oct 4	doc 26.1 kB	Download

Additional Information

pdf
2.3 MB

Download

CAD/CAE-Data**CAE data**

EPLAN Data Portal 769-107/000-036	URL	Download
WSCAD Universe 769-107/000-036	URL	Download
ZUKEN Portal 769-107/000-036	URL	Download
WSCAD Universe 769-107/000-036	URL	Download
EPLAN Data Portal 769-107/000-036	URL	Download

CAD data

2D/3D Models 769-107/000-036	URL	Download
------------------------------	-----	----------

Asset Administration Shell

Asset Administration Shell 769-107/000-036	URL	Download
--	-----	----------

Environmental Product Compliance**Compliance Search**

Subject to changes. Please also observe the further product documentation!

Environmental Product Compliance 769-107/000-036

1-conductor female connector; CAGE CLAMP®; 4 mm²; Pin spacing 5 mm; 7-pole;
coding finger; 4,00 mm²; green-yellow/gray

Installation Notes

Conductor termination

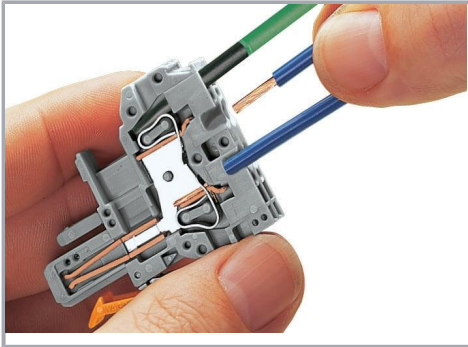

CAGE CLAMP® connection

Female plug: Inserting/removing a conductor via operating tool.

Operation 90° to conductor is also possible.

With ferruled conductors, it is necessary to use a terminal block one size smaller than the conductor's nominal cross-section.

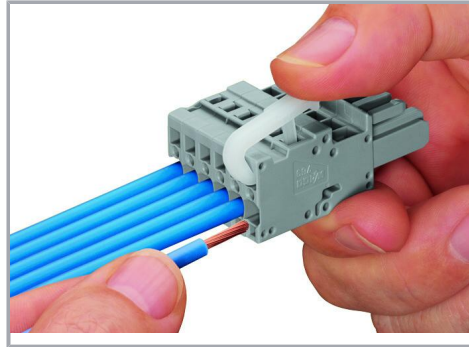

Operating lever

Inserting a conductor – side-entry wiring (example shows a female plug).

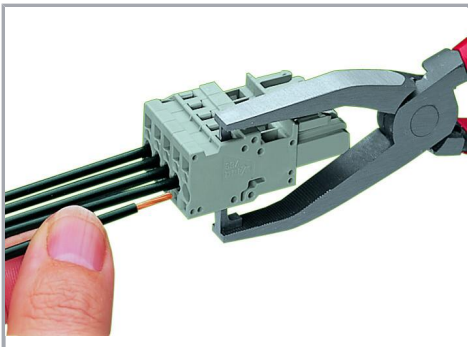

Operating tool

Inserting a conductor – side-entry wiring (example shows a female plug).

With ferruled conductors, it is necessary to use a terminal block one size smaller than the conductor's nominal cross-section.

Commoning

Subject to changes. Please also observe the further product documentation!

WAGO GmbH & Co. KG

Hansastr. 27

32423 Minden

Phone: +49571 887-0 | Fax: +49571 887-169

Email: info.de@wago.com | Web: www.wago.com

Do you have any questions about our products?

We are always happy to take your call at +49 (571) 887-44222.

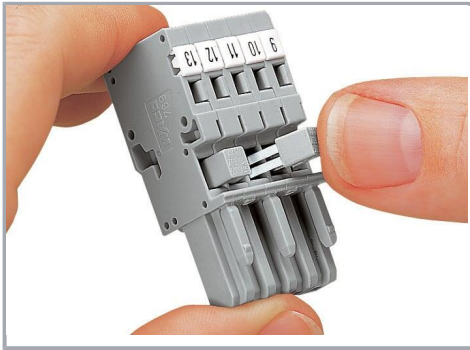

Commoning 1-conductor female plugs via miniature adjacent jumpers.

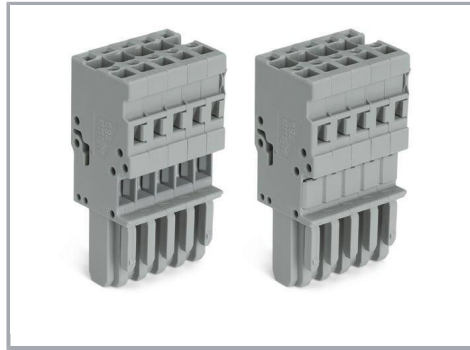

Jumper cover for 1-conductor female plugs

Coding



Coding a female plug by removing coding finger(s) via cutting tool. Do not remove the first and last coding fingers or use an additional locking lever.

Locking system

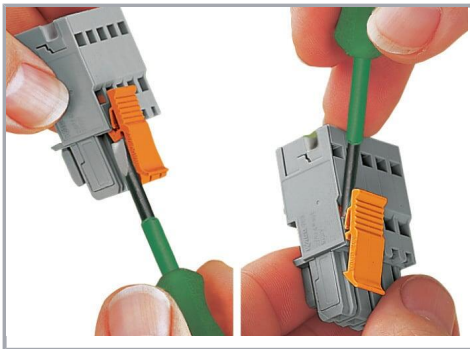

Locking/releasing a lever.

Strain relief

Subject to changes. Please also observe the further product documentation!

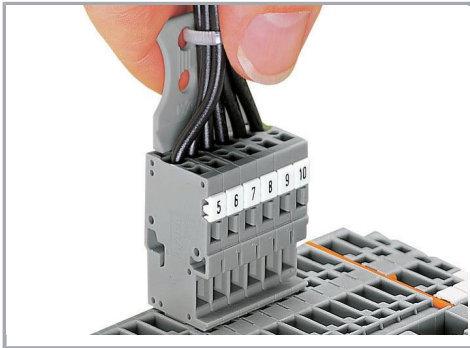

Removing a female plug via conductor bundle provided with strain relief plate.

Marking

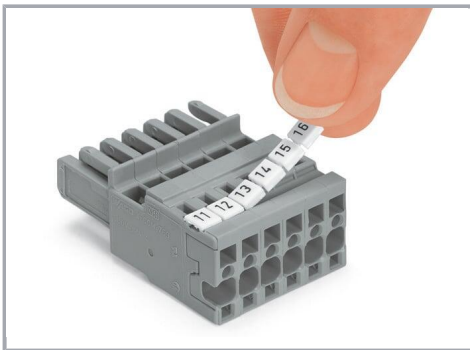

Labeling a female plug with CAGE CLAMP® connection via Mini-WSB Quick Markers.

Product family

X-COM

[Show all products from the family](#)

Subject to changes. Please also observe the further product documentation!