

Data sheet | Item number: 890-245

Socket; 5-pole; Cod. B; 1,50 mm<sup>2</sup>; gray

[www.wago.com/890-245](http://www.wago.com/890-245)

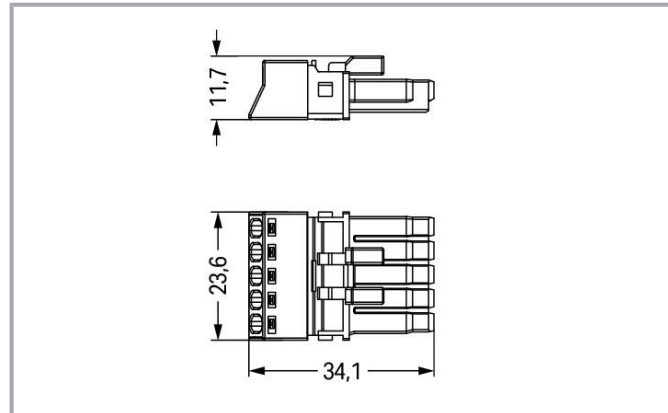
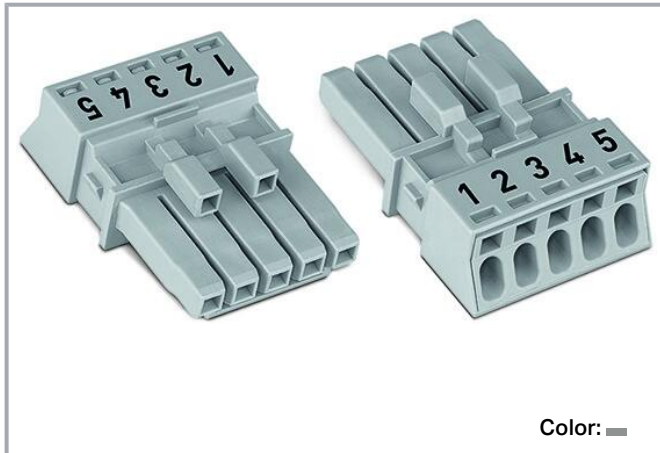

## Item description

### Female connector/socket *WAGOSTA*® MINI with protection against mismatching

The *WAGOSTA*® MINI female connector/socket with protection against mismatching supports rapid, correct installation. WAGO pluggable installation connectors are used when requirements repeat or are planned on a specific pattern, for example for installing grid lighting or flush-mount lighting. The coding options reduce installation errors, allowing fast, secure wiring of all components. Solutions like the *WAGOSTA*® MINI pluggable installation connectors with B coding are appropriate for applications related to process control, for example, for lighting or within data networks. If only limited space is available, our smallest pluggable connection system, *WAGOSTA*® MINI, consistently displays its advantageous properties. It saves space, and, thanks to Push-in CAGE CLAMP® spring pressure connection technology, it additionally can be installed quickly, since the connection is low-maintenance and requires no screw connections.

### *WAGOSTA*® MINI solutions for your electrical installation – protected against mismatching and maintenance-free

The *WAGOSTA*® Pluggable Connection System is ideally tailored to the very strict requirements of building installation. It makes electrical installation pluggable, and thus more efficient, even more reliable, and error-free. Using this pre-assembled system decreases assembly times and installation errors at the construction site. Choose durability and quality – with protection against mismatching from WAGO makes the electrical installation of electrical components visibly easier.

- 
- protection against mismatching eliminates errors
- 

Subject to changes. Please also observe the further product documentation!

WAGO GmbH & Co. KG  
Hansastr. 27  
32423 Minden  
Phone: +49571 887-0 | Fax: +49571 887-169  
Email: [info.de@wago.com](mailto:info.de@wago.com) | Web: [www.wago.com](http://www.wago.com)

Do you have any questions about our products?  
We are always happy to take your call at +49 (571) 887-44222.



- easy tool-free operation, a wide range of coding options
- with B coding for controllers such as lighting fixtures and sun blinds
- exact dimensions
- rapid, structured electrical installation

## Data

### Notes

Variants:

Other pole markings

Other versions (or variants) can be requested from WAGO Sales or configured at <https://configurator.wago.com/>.

## Electrical data

### Ratings per IEC/EN

Ratings per	IEC/EN 60664-1
Nominal voltage (III/3)	400 V
Rated impulse voltage (III/3)	6 kV
Rated current	16 A
Legend (ratings)	(III / 3) ≙ Overvoltage category III / Pollution degree 3

### Ratings per IEC/EN – Notes

Note (rated current)

13 A for 3-pole load

10 A for 4- and 5-pole load

### Ratings per UL 1977

Note for the US market

Some versions may also be used for current interruption in accordance with the UL certificate in select applications with currents below 5 A and voltages up to 600 V. For further information, please contact your local sales office.

Rated voltage (UL 1977)	600 V
Rated current UL 1977	12 A

## General information

Note on contact resistance

approx. 1 mΩ of contact resistance

approx. 0.25 mΩ contact transition plug/socket

Subject to changes. Please also observe the further product documentation!

WAGO GmbH & Co. KG

Hansastr. 27

32423 Minden

Phone: +49571 887-0 | Fax: +49571 887-169

Email: [info.de@wago.com](mailto:info.de@wago.com) | Web: [www.wago.com](http://www.wago.com)

Do you have any questions about our products?

We are always happy to take your call at +49 (571) 887-44222.



## Connection data

Connection points	5
Total number of potentials	5

## Connection 1

Connection technology	Push-in CAGE CLAMP®
Actuation type	Operating tool Push-in
Nominal cross-section	1.5 mm <sup>2</sup> / 16 AWG
Solid conductor	0.25 ... 1.5 mm <sup>2</sup> / 22 ... 16 AWG
Solid conductor; push-in termination	0.75 ... 1.5 mm <sup>2</sup> / 20 ... 16 AWG
Stranded conductor	0.25 ... 1 mm <sup>2</sup> / 22 ... 18 AWG
Fine-stranded conductor	0.25 ... 1.5 mm <sup>2</sup> / 22 ... 16 AWG
Fine-stranded conductor; with insulated ferrule	0.25 ... 0.75 mm <sup>2</sup> / 22 ... 20 AWG
Fine-stranded conductor; with uninsulated ferrule	0.25 ... 0.75 mm <sup>2</sup> / 22 ... 20 AWG
Fine-stranded conductor; with ferrule; push-in termination	0.75 mm <sup>2</sup> / 20 AWG
Strip length	9 mm / 0.35 inches
Pole number	5
Conductor entry direction to mating direction	0°

## Physical data

Pin spacing	4.4 mm / 0.173 inches
Width	23.6 mm / 0.929 inches
Height	11.7 mm / 0.461 inches
Depth	34.1 mm / 1.343 inches

## Mechanical Data

Application	Control technology
Coding	B
Variable coding	No
Marking	1 2 3 4 5
Potential marking	1 2 3 4 5
Mating force of a plug-in connection	approx. 20 ... 70 N (depending on pole number)
Retention force of a plug-in connection	Locked: > 80 N
Unmating force of a plug-in connection	Unlocked: approx. 20 ... 70 N (depending on pole number)

Subject to changes. Please also observe the further product documentation!



Number of mating cycles	200, without resistive load
Protection type	IP20; IP40 with strain relief housing

### Plug-in connection

Contact type (pluggable connector)	Female connector/socket
Connector (connection type)	for conductor
Mismating protection	Yes
Note on mismating protection	All <i>WINSTA</i> <sup>®</sup> components are 100% protected against mismating when: a.) plugging different numbers of poles b.) plugging while rotated 180 c.) plugging while laterally staggered d.) plugging one pole
Locking lever	Can be retrofitted
Locking of plug-in connection	locking lever
Note on locking system	All connectors for mounted installations (snap-in versions for lighting fixtures or devices, all types of PCB and distribution connectors) are factory-equipped with locking levers to ensure plugs and sockets are securely locked. Additional locking levers are only required for flying leads (plug/socket).

### Material data

Note (material data)	Information on material specifications can be found here
Color	gray
Cover color	gray
Material group	I
Insulation material	Polyamide (PA66)
Flammability class per UL94	V0
Clamping spring material	Chrome-nickel spring steel (CrNi)
Contact material	Copper or copper alloy; surface-treated
Contact plating	Tin
Fire load	0.152 MJ
Weight	6 g

### Environmental requirements

Processing temperature	-5 ... +40 °C
Continuous operating temperature	-35 ... +85 °C

Subject to changes. Please also observe the further product documentation!

Note on continuous operating temperature

Insulating parts for temperatures  $\leq 105\text{ }^{\circ}\text{C}$ 

## Commercial data

Product Group	20 (Winsta)
eCl@ss 10.0	27-44-06-05
eCl@ss 9.0	27-44-06-05
ETIM 8.0	EC002560
ETIM 7.0	EC002560
ECCN	NO DATA
PU (SPU)	50 pcs
Packaging type	box
Country of origin	PL
GTIN	4055143499774
Customs tariff number	85366990990



## Environmental Product Compliance

RoHS Compliance Status

Compliant, No Exemption

## Approvals / Certificates

### General approvals

Logo	Approval	Additional Approval Text	Certificate name
	CB DEKRA Certification B.V.	EN 61984	NL-64351
	CB DEKRA Certification B.V.	EN 61984	71-112993
	cURus Underwriters Laboratories Inc.	UL 1977	E45171
	KEMA/KEUR DEKRA Certification B.V.	EN 60320	2148952.04

## Declarations of conformity and manufacturer's declarations

Logo	Approval	Additional Approval Text	Certificate name
------	----------	--------------------------	------------------

Subject to changes. Please also observe the further product documentation!

WAGO GmbH &amp; Co. KG

Hansastr. 27

32423 Minden

Phone: +49571 887-0 | Fax: +49571 887-169

Email: [info.de@wago.com](mailto:info.de@wago.com) | Web: [www.wago.com](http://www.wago.com)

Do you have any questions about our products?

We are always happy to take your call at +49 (571) 887-44222.



EU-Declaration of Conformity  
WAGO GmbH & Co. KG

-

-





UK-Declaration of Conformity  
WAGO GmbH & Co. KG







-

-

### Approvals for marine applications

Logo	Approval	Additional Approval Text	Certificate name
	<b>DNV GL</b> Det Norske Veritas, Germanischer Lloyd	-	TAE00001Z6
	<b>LR</b> Lloyds Register	EN 61535	08/20047 (E2)

### Counterpart

	<b>Item no.890-755</b> Snap-in plug; 5-pole; Cod. B; 1,50 mm <sup>2</sup> ; gray	<a href="http://www.wago.com/890-755">www.wago.com/890-755</a>
	<b>Item no.890-855</b> Plug for PCBs; straight; 5-pole; Cod. B; gray	<a href="http://www.wago.com/890-855">www.wago.com/890-855</a>
	<b>Item no.890-255</b> Plug; 5-pole; Cod. B; 1,50 mm <sup>2</sup> ; gray	<a href="http://www.wago.com/890-255">www.wago.com/890-255</a>
	<b>Item no.890-855/011-000</b> Plug for PCBs; angled; 5-pole; Cod. B; gray	<a href="http://www.wago.com/890-855/011-000">www.wago.com/890-855/011-000</a>
	<b>Item no.891-8995/005-103</b> pre-assembled interconnecting cable; Eca; Socket/plug; 5-pole; Cod. B; (H)05VV-F 5x1,0 mm <sup>2</sup> ; 1 m; 1,00 mm <sup>2</sup> ; gray	<a href="http://www.wago.com/891-8995/005-103">www.wago.com/891-8995/005-103</a>
	<b>Item no.891-8995/205-103</b> pre-assembled connecting cable; Eca; Plug/open-ended; 5-pole; Cod. B; (H)05VV-F 5x1,0 mm <sup>2</sup> ; 1 m; 1,00 mm <sup>2</sup> ; gray	<a href="http://www.wago.com/891-8995/205-103">www.wago.com/891-8995/205-103</a>

### Required accessories

#### Strain relief

Strain relief housing

Subject to changes. Please also observe the further product documentation!



**Item no.: 890-505**

Strain relief housing; 5-pole; with locking clip; for 1 cable; 6.5 ... 10.5 mm; 45 mm; black

[www.wago.com/890-505](http://www.wago.com/890-505)



**Item no.: 890-515**

Strain relief housing; 5-pole; with locking clip; for 1 cable; 6.5 ... 10.5 mm; 45 mm; white

[www.wago.com/890-515](http://www.wago.com/890-515)

## Locking levers

### Locking system



**Item no.: 890-111**

Locking lever; for flying leads; for tool operation; black

[www.wago.com/890-111](http://www.wago.com/890-111)



**Item no.: 890-101**

Locking lever; for manual operation; black

[www.wago.com/890-101](http://www.wago.com/890-101)



**Item no.: 890-121**

Locking lever; for manual operation; white

[www.wago.com/890-121](http://www.wago.com/890-121)



**Item no.: 890-131**

Locking lever; for flying leads; for tool operation; white

[www.wago.com/890-131](http://www.wago.com/890-131)

## Optional accessories

### Cover

#### Cover



**Item no.: 897-2003**

Protective cap; Type2; for sockets and plugs; PVC; red

[www.wago.com/897-2003](http://www.wago.com/897-2003)

### Mounting

#### Mounting accessories



**Item no.: 890-310**

Mounting carrier; 2- to 5-pole; for flying leads; black

[www.wago.com/890-310](http://www.wago.com/890-310)



**Item no.: 890-311**

Mounting carrier; 2- to 5-pole; for flying leads; white

[www.wago.com/890-311](http://www.wago.com/890-311)

### Tool

#### Operating tool

Subject to changes. Please also observe the further product documentation!

WAGO GmbH & Co. KG

Hansastr. 27

32423 Minden

Phone: +49571 887-0 | Fax: +49571 887-169

Email: [info.de@wago.com](mailto:info.de@wago.com) | Web: [www.wago.com](http://www.wago.com)

Do you have any questions about our products?

We are always happy to take your call at +49 (571) 887-44222.



Item no.: 210-719

Operating tool; Blade: 2.5 x 0.4 mm; with a partially insulated shaft



Item no.: 890-385

Operating tool; 5-way; green

## Downloads

### Documentation

#### Bid Text

890-245 X81 - Datei	2019 Feb 19	xml 3.0 kB	Download
890-245 doc - Datei	2015 Jun 8	doc 24.1 kB	Download

### CAD/CAE-Data

#### CAE data

ZUKEN Portal 890-245	URL	Download
----------------------	-----	----------

#### CAD data

2D/3D Models 890-245	URL	Download
----------------------	-----	----------

#### Asset Administration Shell

Asset Administration Shell 890-245	URL	Download
------------------------------------	-----	----------

### Environmental Product Compliance

#### Compliance Search

Environmental Product Compliance 890-245 Socket; 5-pole; Cod. B; 1,50 mm <sup>2</sup> ; gray	URL	Download
---	-----	----------

### Installation Notes

#### Conductor termination

Subject to changes. Please also observe the further product documentation!



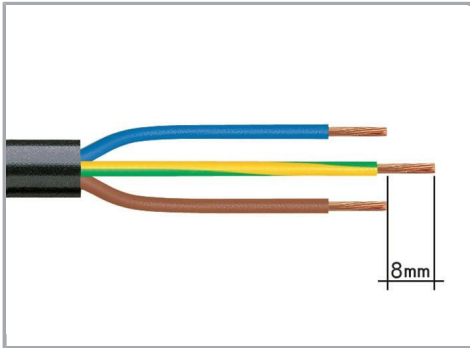

1. Strip length, outer insulation = 30 mm (2-pole), 37 mm (3-pole), 45 mm (4- and 5-pole)
2. Strip length = 9 mm
3. Extended ground conductor = 8 mm

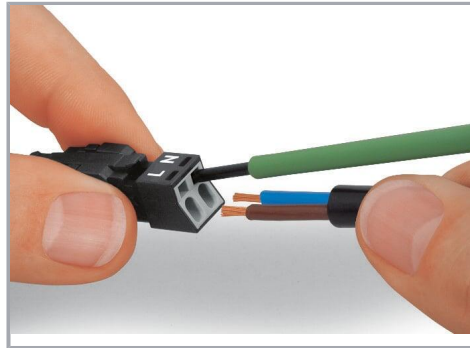

To terminate fine-stranded conductors, open the clamping unit via screwdriver – 2.5 mm blade width – and insert a stripped conductor until it hits the backstop. Terminate solid conductors by simply pushing them in.

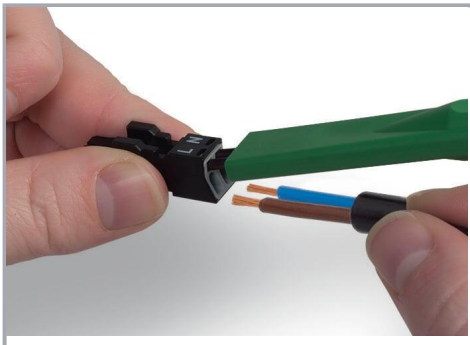

To terminate fine-stranded conductors, open clamping units via operating tool (890-382) and insert stripped conductors until they hit backstop. Terminate solid conductors by simply pushing them in.

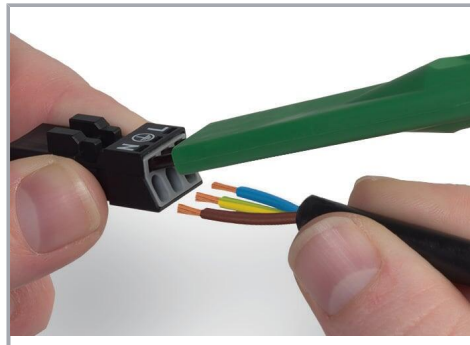

To terminate fine-stranded conductors, open clamping units via operating tool (890-383) and insert stripped conductors until they hit backstop. Terminate solid conductors by simply pushing them in.

## Installation

Subject to changes. Please also observe the further product documentation!

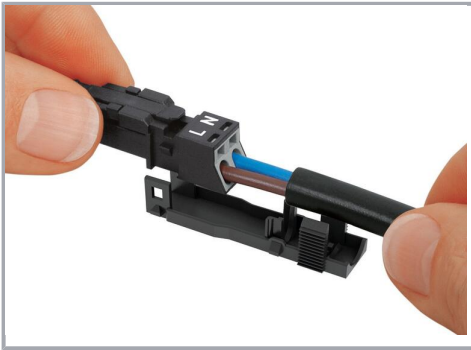

Latch the wired connector into the base of the strain relief housing.

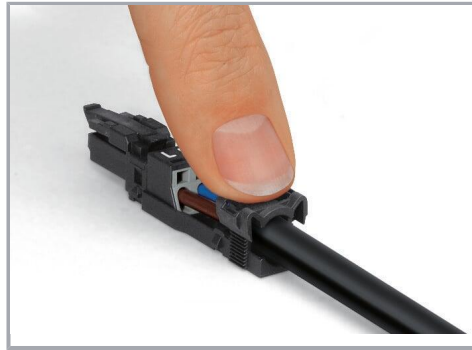

Push down strain relief clamp by hand.



Push down strain relief clamp with 2.5 mm screwdriver alternately on both sides.

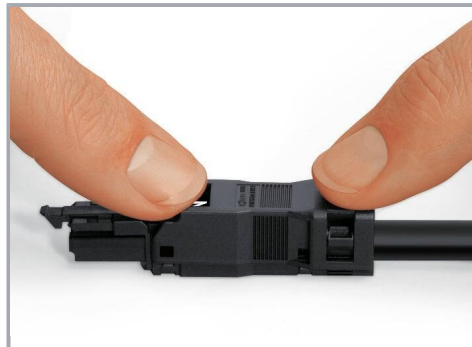

Latch the top of the strain relief housing.

Subject to changes. Please also observe the further product documentation!



The printed marking of the connector is clearly visible in the openings of the strain relief housing.

#### Mismatching protection

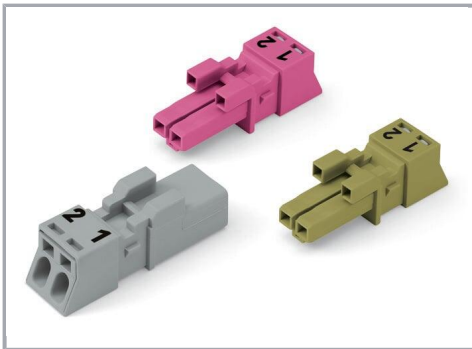

B-coded connectors with different colors can be plugged together.

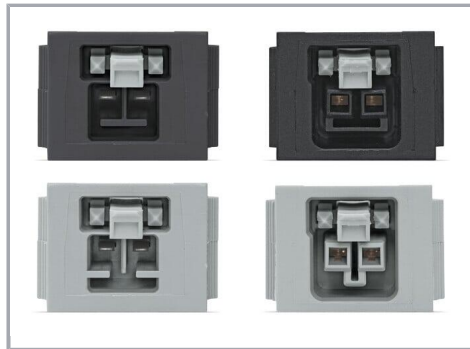

B-coded connectors (shown in gray) not only differ in color, but also in their design, making them incompatible with other coded connectors.

#### Important note:

Different colors and/or pole markings are used for circuit identification.

Only connectors of the same color and same pole marking must be plugged together.



Subject to changes. Please also observe the further product documentation!

Data sheet | Item number: 890-245

[www.wago.com/890-245](http://www.wago.com/890-245)



## Product family

**WINSTA® MINI**

[Show all products from the family](#)

Subject to changes. Please also observe the further product documentation!

---

WAGO GmbH & Co. KG

Hansastr. 27

32423 Minden

Phone: +49571 887-0 | Fax: +49571 887-169

Email: [info.de@wago.com](mailto:info.de@wago.com) | Web: [www.wago.com](http://www.wago.com)

Do you have any questions about our products?

We are always happy to take your call at +49 (571) 887-44222.