

**Data sheet | Item number: 769-106/000-036**

1-conductor female connector; CAGE CLAMP®; 4 mm<sup>2</sup>; Pin spacing 5 mm; 6-pole; coding finger; 4,00 mm<sup>2</sup>; green-yellow/gray

[www.wago.com/769-106/000-036](http://www.wago.com/769-106/000-036)

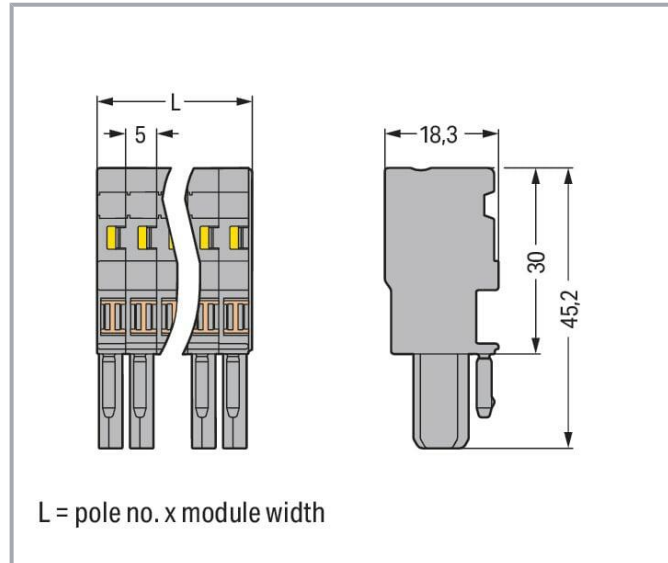
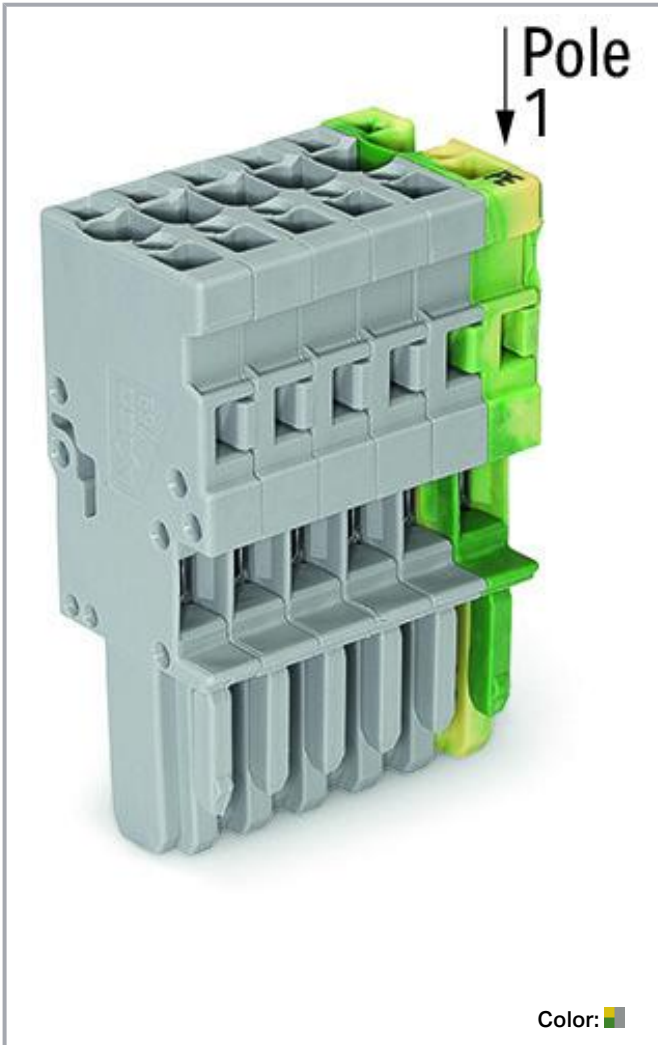

**Data  
Notes**

Safety information

According to EN 61984, pluggable connectors without current interrupting capacity must not be mated or unmated when live or under load.

**Electrical data**

Subject to changes. Please also observe the further product documentation!

WAGO GmbH & Co. KG  
Hansastr. 27  
32423 Minden  
Phone: +49571 887-0 | Fax: +49571 887-169  
Email: [info.de@wago.com](mailto:info.de@wago.com) | Web: [www.wago.com](http://www.wago.com)

Do you have any questions about our products?  
We are always happy to take your call at +49 (571) 887-44222.



## Ratings per IEC/EN

Ratings per	IEC/EN 61984
Nominal voltage (III/3)	500 V
Rated impulse voltage (III/3)	6 kV
Rated current	32 A
Legend (ratings)	(III / 3) $\hat{=}$ Overvoltage category III / Pollution degree 3

## Connection data

Connection points	6
Total number of potentials	6

## Connection 1

Connection technology	CAGE CLAMP®
Actuation type	Operating tool
Connectable conductor materials	Copper
Nominal cross-section	4 mm <sup>2</sup> / 12 AWG
Solid conductor	0.08 ... 4 mm <sup>2</sup> / 28 ... 12 AWG
Fine-stranded conductor	0.08 ... 4 mm <sup>2</sup> / 28 ... 12 AWG
Strip length	8 ... 9 mm / 0.31 ... 0.35 inches
Pole number	6
Wiring direction	Front-entry wiring

## Physical data

Width	30 mm / 1.181 inches
Height	45.2 mm / 1.78 inches
Depth	18.3 mm / 0.72 inches
Module width	5 mm / 0.197 inches

## Mechanical Data

Variable coding	Yes
Direct ground contact to DIN-rail/drilled hole/housing	No
Marking level	Side marking
Anti-rotation protection	Yes

Subject to changes. Please also observe the further product documentation!

WAGO GmbH & Co. KG  
 Hansastr. 27  
 32423 Minden  
 Phone: +49571 887-0 | Fax: +49571 887-169  
 Email: [info.de@wago.com](mailto:info.de@wago.com) | Web: [www.wago.com](http://www.wago.com)

Do you have any questions about our products?  
 We are always happy to take your call at +49 (571) 887-44222.



## Plug-in connection

Contact type (pluggable connector)	Female connector/socket
Connector (connection type)	for conductor
Mismatching protection	No
Plugging without loss of pin spacing	Yes

## Material data

Note (material data)	Information on material specifications can be found here
Color	green-yellow/gray
Material group	I
Insulation material	Polyamide (PA66)
Flammability class per UL94	V0
Fire load	0.365 MJ
Halogen-free	Yes
Weight	18.9 g

## Environmental requirements

Processing temperature	-35 ... +85 °C
Continuous operating temperature	-60 ... +105 °C

## Commercial data

eCl@ss 10.0	27-14-11-06
eCl@ss 9.0	27-14-11-06
ETIM 8.0	EC001284
ETIM 7.0	EC001284
ECCN	NO DATA
PU (SPU)	25 pcs
Packaging type	box
Country of origin	DE
GTIN	4045454486686
Customs tariff number	85366990990

Subject to changes. Please also observe the further product documentation!



## Environmental Product Compliance

RoHS Compliance Status

Compliant, No Exemption

## Approvals / Certificates

### General approvals

Logo	Approval	Additional Approval Text	Certificate name
	CSA CSA Group	C22.2	1101144
	UL Underwriters Laboratories Inc.	UL 1977	E 45171
	UR Underwriters Laboratories Inc.	UL 1059	E45172

## Optional accessories



### Insulation stop

Insulation stop

**Item no.: 769-470**Insulation stop; 0.08 - 0.2 mm<sup>2</sup> "s" (0.14 mm<sup>2</sup> "f-st"); 5 pieces/strip; white[www.wago.com/769-470](http://www.wago.com/769-470)**Item no.: 769-471**Insulation stop; 0.25 - 0.5 mm<sup>2</sup>; 5 pieces/strip; light gray[www.wago.com/769-471](http://www.wago.com/769-471)**Item no.: 769-472**Insulation stop; 0.75 - 1 mm<sup>2</sup>; 5 pieces/strip; dark gray[www.wago.com/769-472](http://www.wago.com/769-472)

### Ferrule

Ferrule

	<b>Item no.: 216-101</b> Ferrule; Sleeve for 0.5 mm <sup>2</sup> / AWG 22; uninsulated; electro-tin plated; silver-colored	<a href="http://www.wago.com/216-101">www.wago.com/216-101</a>
	<b>Item no.: 216-104</b> Ferrule; Sleeve for 1.5 mm <sup>2</sup> / AWG 16; uninsulated; electro-tin plated; silver-colored	<a href="http://www.wago.com/216-104">www.wago.com/216-104</a>

Subject to changes. Please also observe the further product documentation!

WAGO GmbH &amp; Co. KG

Hansastr. 27















32423 Minden

Phone: +49571 887-0 | Fax: +49571 887-169

Email: [info.de@wago.com](mailto:info.de@wago.com) | Web: [www.wago.com](http://www.wago.com)

Do you have any questions about our products?

We are always happy to take your call at +49 (571) 887-44222.

	<b>Item no.: 216-102</b> Ferrule; Sleeve for 0.75 mm <sup>2</sup> / AWG 20; uninsulated; electro-tin plated; silver-colored	<a href="http://www.wago.com/216-102">www.wago.com/216-102</a>
	<b>Item no.: 216-103</b> Ferrule; Sleeve for 1 mm <sup>2</sup> / AWG 18; uninsulated; electro-tin plated	<a href="http://www.wago.com/216-103">www.wago.com/216-103</a>
	<b>Item no.: 216-203</b> Ferrule; Sleeve for 1 mm <sup>2</sup> / AWG 18; insulated; electro-tin plated; red	<a href="http://www.wago.com/216-203">www.wago.com/216-203</a>
	<b>Item no.: 216-206</b> Ferrule; Sleeve for 2.5 mm <sup>2</sup> / AWG 14; insulated; electro-tin plated; blue	<a href="http://www.wago.com/216-206">www.wago.com/216-206</a>
	<b>Item no.: 216-202</b> Ferrule; Sleeve for 0.75 mm <sup>2</sup> / 18 AWG; insulated; electro-tin plated; gray	<a href="http://www.wago.com/216-202">www.wago.com/216-202</a>
	<b>Item no.: 216-204</b> Ferrule; Sleeve for 1.5 mm <sup>2</sup> / AWG 16; insulated; electro-tin plated; black	<a href="http://www.wago.com/216-204">www.wago.com/216-204</a>
	<b>Item no.: 216-201</b> Ferrule; Sleeve for 0.5 mm <sup>2</sup> / 20 AWG; insulated; electro-tin plated; white	<a href="http://www.wago.com/216-201">www.wago.com/216-201</a>
	<b>Item no.: 216-301</b> Ferrule; Sleeve for 0.25 mm <sup>2</sup> / AWG 24; insulated; electro-tin plated; yellow	<a href="http://www.wago.com/216-301">www.wago.com/216-301</a>
	<b>Item no.: 216-302</b> Ferrule; Sleeve for 0.34 mm <sup>2</sup> / 22 AWG; insulated; electro-tin plated; light turquoise	<a href="http://www.wago.com/216-302">www.wago.com/216-302</a>
<b>Strain relief</b>		
Strain relief		
	<b>Item no.: 769-1606</b> Strain relief housing; for female and male connectors; 2 parts; Pin spacing 5 mm; 6-pole; gray	<a href="http://www.wago.com/769-1606">www.wago.com/769-1606</a>
	<b>Item no.: 769-413</b> Strain relief plate; for female and male connectors; 1 part; Pin spacing 5 mm; 6- to 9-pole; gray	<a href="http://www.wago.com/769-413">www.wago.com/769-413</a>
<b>Cover</b>		
Cover		
	<b>Item no.: 769-436</b> Jumper cover; for 1-conductor female plugs; for 5 poles; gray	<a href="http://www.wago.com/769-436">www.wago.com/769-436</a>
<b>Marking accessories</b>		
Marking strip		
	<b>Item no.: 210-831</b> Marking strips; on reel; 2.3 mm wide; plain; Self-adhesive; white	<a href="http://www.wago.com/210-831">www.wago.com/210-831</a>
	<b>Item no.: 210-834</b> Marking strips; on reel; 5 mm wide; plain; Self-adhesive; white	<a href="http://www.wago.com/210-834">www.wago.com/210-834</a>
	<b>Item no.: 210-832</b> Marking strips; on reel; 3 mm wide; plain; Self-adhesive; white	<a href="http://www.wago.com/210-832">www.wago.com/210-832</a>

Subject to changes. Please also observe the further product documentation!

Label



**Item no.: 210-805**  
Labels; for Smart Printer; permanent adhesive; 6 x 15 mm; white

[www.wago.com/210-805](http://www.wago.com/210-805)



**Item no.: 210-805/000-002**  
Labels; for Smart Printer; permanent adhesive; 6 x 15 mm; yellow

[www.wago.com/210-805/000-002](http://www.wago.com/210-805/000-002)

Marker



**Item no.: 2009-145**  
Mini-WSB Inline; for Smart Printer; 1700 pieces on roll; stretchable 5 - 5.2 mm; plain; snap-on type; white

[www.wago.com/2009-145](http://www.wago.com/2009-145)



**Item no.: 248-501**  
Mini-WSB marking card; as card; not stretchable; plain; snap-on type; white

[www.wago.com/248-501](http://www.wago.com/248-501)

Protective warning marker

Cover



**Item no.: 280-415**  
Protective warning marker; for 5 terminal blocks; with high-voltage symbol, black; yellow

[www.wago.com/280-415](http://www.wago.com/280-415)

Tool

Operating tool



**Item no.: 210-490**  
Operating tool

[www.wago.com/210-490](http://www.wago.com/210-490)



**Item no.: 769-434**  
Operating tool; made of insulating material; 1-way; loose; white

[www.wago.com/769-434](http://www.wago.com/769-434)

Jumpers

Jumper



**Item no.: 769-402**  
Jumper; insulated; gray

[www.wago.com/769-402](http://www.wago.com/769-402)

Locking levers

Locking system



**Item no.: 769-430**  
Locking lever; for female connectors; 1 part; Pin spacing 5 mm; 2-pole; gray

[www.wago.com/769-430](http://www.wago.com/769-430)



**Item no.: 769-431**  
Locking lever; for female connectors; 1 part; Pin spacing 5 mm; 2-pole; orange

[www.wago.com/769-431](http://www.wago.com/769-431)

Testing and measuring

Testing accessories

Subject to changes. Please also observe the further product documentation!



Item no.: 210-136

Test plug; 2 mm Ø; with 500 mm cable; red

## Downloads

### Documentation

#### Bid Text

769-106/000-036 X81 - Datei	2019 Feb 19	xml 3.3 kB	Download
--------------------------------	-------------	---------------	----------

769-106/000-036 doc - Datei	2017 Oct 4	doc 26.1 kB	Download
--------------------------------	------------	----------------	----------

#### Additional Information

		pdf 2.3 MB	Download
--	--	---------------	----------

## CAD/CAE-Data

### CAE data

EPLAN Data Portal 769-106/000-036		URL	Download
-----------------------------------	--	-----	----------

WSCAD Universe 769-106/000-036		URL	Download
--------------------------------	--	-----	----------

WSCAD Universe 769-106/000-036		URL	Download
--------------------------------	--	-----	----------

EPLAN Data Portal 769-106/000-036		URL	Download
-----------------------------------	--	-----	----------

ZUKEN Portal 769-106/000-036		URL	Download
------------------------------	--	-----	----------

### CAD data

2D/3D Models 769-106/000-036		URL	Download
------------------------------	--	-----	----------

### Asset Administration Shell

Asset Administration Shell 769-106/000-036		URL	Download
--	--	-----	----------

## Environmental Product Compliance

Subject to changes. Please also observe the further product documentation!

## Compliance Search

Environmental Product Compliance 769-106/000-036

URL

Download

1-conductor female connector; CAGE CLAMP®; 4 mm<sup>2</sup>; Pin spacing 5 mm; 6-pole; coding finger; 4,00 mm<sup>2</sup>; green-yellow/gray

## Installation Notes

### Conductor termination

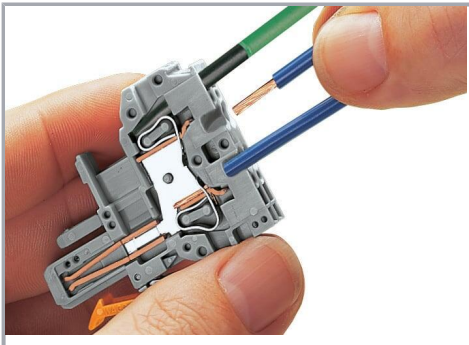

#### CAGE CLAMP® connection

Female plug: Inserting/removing a conductor via operating tool.

Operation 90° to conductor is also possible.

With ferruled conductors, it is necessary to use a terminal block one size smaller than the conductor's nominal cross-section.

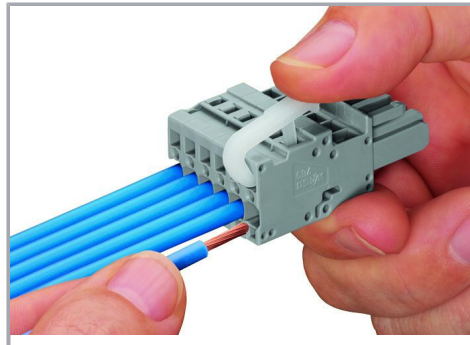

#### Operating lever

Inserting a conductor – side-entry wiring (example shows a female plug).

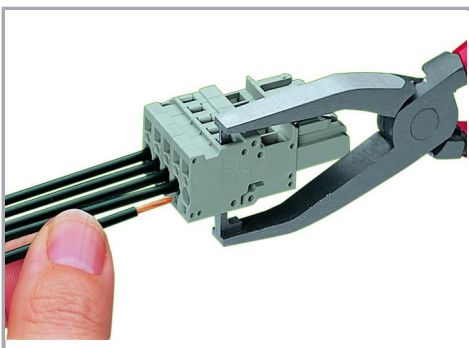

#### Operating tool

Inserting a conductor – side-entry wiring (example shows a female plug).

With ferruled conductors, it is necessary to use a terminal block one size smaller than the conductor's nominal cross-section.

Subject to changes. Please also observe the further product documentation!

WAGO GmbH & Co. KG

Hansastr. 27

32423 Minden

Phone: +49571 887-0 | Fax: +49571 887-169

Email: [info.de@wago.com](mailto:info.de@wago.com) | Web: [www.wago.com](http://www.wago.com)

Do you have any questions about our products?

We are always happy to take your call at +49 (571) 887-44222.



### Commoning

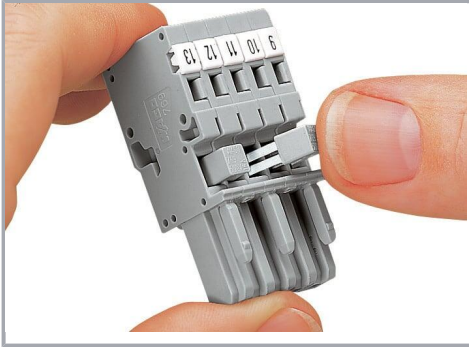

Commoning 1-conductor female plugs via miniature adjacent jumpers.

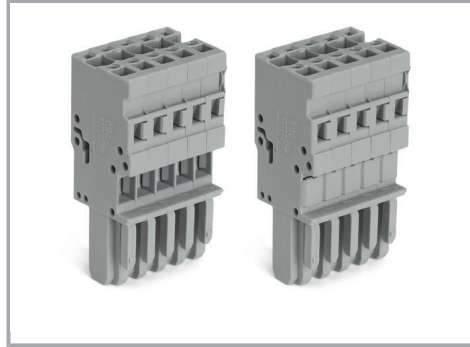

Jumper cover for 1-conductor female plugs

### Coding



Coding a female plug by removing coding finger(s) via cutting tool. Do not remove the first and last coding fingers or use an additional locking lever.

### Locking system

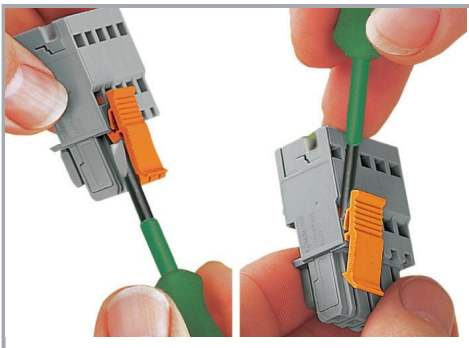

Locking/releasing a lever.

### Strain relief

Subject to changes. Please also observe the further product documentation!

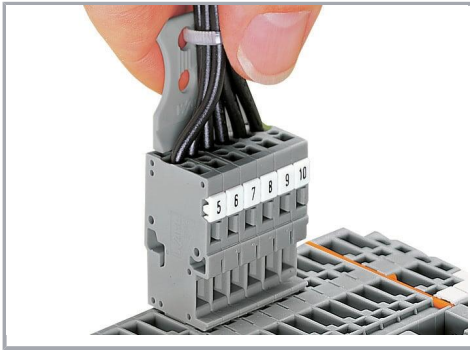

Removing a female plug via conductor bundle provided with strain relief plate.

### Marking

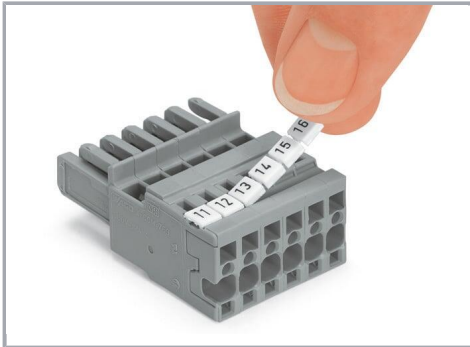

Labeling a female plug with CAGE CLAMP® connection via Mini-WSB Quick Markers.

### Product family

**X-COM**

[Show all products from the family](#)

Subject to changes. Please also observe the further product documentation!