

Data sheet | Item number: 231-607/019-000

1-conductor male connector; CAGE CLAMP®; 2.5 mm²; Pin spacing 5 mm; 7-pole; clamping collar; 2,50 mm²; gray

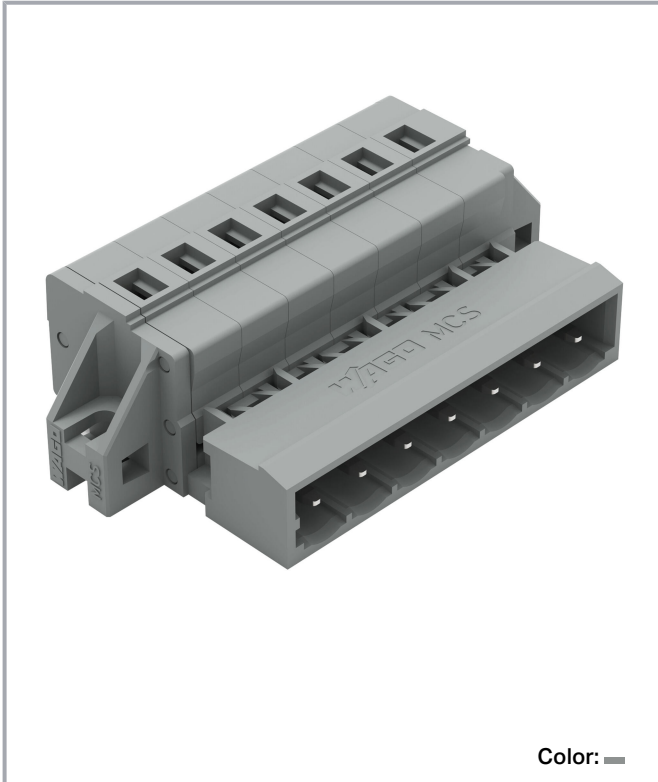

www.wago.com/231-607/019-000



Subject to changes. Please also observe the further product documentation!

WAGO GmbH & Co. KG
Hansastr. 27
32423 Minden
Phone: +49571 887-0 | Fax: +49571 887-169
Email: info.de@wago.com | Web: www.wago.com

Do you have any questions about our products?
We are always happy to take your call at +49 (571) 887-44222.

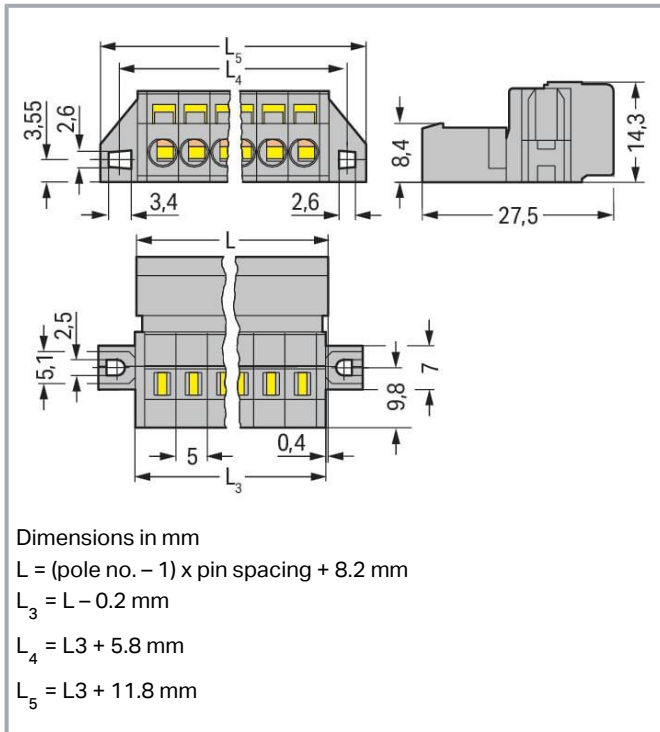

Item description

- Universal connection for all conductor types
- Easy cable pre-assembly and on-unit wiring via vertical and horizontal CAGE CLAMP® actuation
- For wire-to-wire and board-to-wire connections
- Versions available with snap-in mounting feet or flanges for panel or through-panel mounting
- With coding fingers

Data

Notes

Safety information

The *MCS – MULTI CONNECTION SYSTEM* includes connectors without breaking capacity in accordance with DIN EN 61984. When used as intended, these connectors must not be connected /disconnected when live or under load. When used as intended, these connectors must not be connected/disconnected when live or under load. The circuit design should ensure header pins, which can be touched, are not live when unmated.

Variants:

Other pole numbers
 Gold-plated or partially gold-plated contact surfaces

Subject to changes. Please also observe the further product documentation!



Other versions (or variants) can be requested from WAGO Sales or configured at <https://configurator.wago.com/>.

Electrical data

Ratings per IEC/EN

Ratings per	IEC/EN 60664-1
Nominal voltage (III/3)	320 V
Rated impulse voltage (III/3)	4 kV
Rated voltage (III/2)	320 V
Rated impulse voltage (III/2)	4 kV
Nominal voltage (II/2)	630 V
Rated surge voltage (II/2)	4 kV
Rated current	12 A
Legend (ratings)	(III / 2) $\hat{=}$ Overvoltage category III / Pollution degree 2

Ratings per UL

Approvals per	UL 1059
Rated voltage UL (Use Group B)	300 V
Rated current UL (Use Group B)	15 A
Rated voltage UL (Use Group D)	300 V
Rated current UL (Use Group D)	10 A

Ratings per UL 1977

Rated voltage (UL 1977)	600 V
Rated current UL 1977	15 A

Ratings per CSA

Approvals per	CSA
Rated voltage CSA (Use Group B)	300 V
Rated current CSA (Use Group B)	15 A
Rated voltage CSA (Use Group D)	300 V
Rated current CSA (Use Group D)	10 A

Connection data

Connection points	7
-------------------	---

Subject to changes. Please also observe the further product documentation!



Total number of potentials	7
Number of connection types	1
Number of levels	1

Connection 1

Connection technology	CAGE CLAMP®
Actuation type	Operating tool
Actuation direction 1	Operation parallel to conductor entry
Actuation direction 2	Operation perpendicular to conductor entry
Solid conductor	0.08 ... 2.5 mm ² / 28 ... 12 AWG
Fine-stranded conductor	0.08 ... 2.5 mm ² / 28 ... 12 AWG
Fine-stranded conductor; with insulated ferrule	0.25 ... 1.5 mm ²
Fine-stranded conductor; with uninsulated ferrule	0.25 ... 2.5 mm ²
Strip length	8 ... 9 mm / 0.31 ... 0.35 inches
Pole number	7
Conductor entry direction to mating direction	0°

Physical data

Pin spacing	5 mm / 0.197 inches
Width	49.8 mm / 1.961 inches
Height	14.3 mm / 0.563 inches
Depth	27.5 mm / 1.083 inches

Mechanical Data

Variable coding	Yes
Mounting type	Mounting flange
Mounting type	Feed-through mounting Panel mounting
Anti-rotation protection	Yes

Plug-in connection

Contact type (pluggable connector)	Male connector/plug
Connector (connection type)	for conductor
Mismating protection	No
Plugging without loss of pin spacing	No
Locking of plug-in connection	none

Subject to changes. Please also observe the further product documentation!



Material data

Note (material data)

Information on material specifications can be found here

Color	gray
Material group	I
Insulation material	Polyamide (PA66)
Flammability class per UL94	V0
Clamping spring material	Chrome-nickel spring steel (CrNi)
Contact material	Electrolytic copper (E _{Cu})
Contact plating	Tin
Fire load	0.359 MJ
Weight	11.4 g

Environmental requirements

Limit temperature range	-60 ... +100 °C
Processing temperature	-35 ... +60 °C

Commercial data

Product Group	3 (Multi Conn. System)
eCl@ss 10.0	27-44-03-09
eCl@ss 9.0	27-44-03-09
ETIM 8.0	EC002638
ETIM 7.0	EC002638
ECCN	NO DATA
PU (SPU)	50 pcs
Packaging type	box
Country of origin	DE
GTIN	4044918257695
Customs tariff number	85366930000

Environmental Product Compliance

RoHS Compliance Status	Compliant, No Exemption
------------------------	-------------------------

Approvals / Certificates

General approvals

Subject to changes. Please also observe the further product documentation!

WAGO GmbH & Co. KG
 Hansastr. 27
 32423 Minden
 Phone: +49571 887-0 | Fax: +49571 887-169
 Email: info.de@wago.com | Web: www.wago.com



Do you have any questions about our products?
 We are always happy to take your call at +49 (571) 887-44222.

Logo	Approval	Additional Approval Text	Certificate name
	CB DEKRA Certification B.V.	IEC 61984	NL-39756/A1
	CCC CQC	GB/T 13140.1	CQC03003003013
	CSA DEKRA Certification B.V.	C22.2	LR 18677-25
	KEMA/KEUR DEKRA Certification B.V.	EN 61984	71-121453
	UL Underwriters Laboratories Inc.	UL 1977	E45171

Declarations of conformity and manufacturer's declarations

Logo	Approval	Additional Approval Text	Certificate name
	Railway WAGO GmbH & Co. KG	-	Railway Ready

Approvals for marine applications

Logo	Approval	Additional Approval Text	Certificate name
	ABS American Bureau of Shipping	-	19- HG1869876- PDA
	BV Bureau Veritas S.A.	IEC 60998	11915/DO BV
	DNV DNV GL SE	-	TAE000016Z

Subject to changes. Please also observe the further product documentation!

WAGO GmbH & Co. KG
Hansastr. 27
32423 Minden
Phone: +49571 887-0 | Fax: +49571 887-169
Email: info.de@wago.com | Web: www.wago.com

Do you have any questions about our products?
We are always happy to take your call at +49 (571) 887-44222.

Counterpart



Item no.231-107/026-000

1-conductor female connector; CAGE CLAMP®; 2.5 mm²; Pin spacing 5 mm; 7-pole; 2,50 mm²; gray

www.wago.com/231-107/026-000



Item no.232-137

THT female header; straight; Pin spacing 5 mm; 7-pole; 0.6 x 1.0 mm solder pin; gray

www.wago.com/232-137



Item no.232-237

THT female header; angled; Pin spacing 5 mm; 7-pole; 0.6 x 1.0 mm solder pin; gray

www.wago.com/232-237

Optional accessories

Mounting

Mounting accessories



Item no.: 209-147

Self-tapping screw

www.wago.com/209-147



Item no.: 231-194

Self-tapping screw; B 2.2x13, fixing hole 1.8 mm Ø

www.wago.com/231-194



Item no.: 231-195

Screw with nut; M2x12; for fixing element

www.wago.com/231-195



Item no.: 231-295

Screw with nut

www.wago.com/231-295

Coding

Coding



Item no.: 231-129

Coding key; snap-on type; light gray

www.wago.com/231-129

Insulation stop

Insulation stop



Item no.: 231-672

Insulation stop; 0.75 - 1 mm²; dark gray

www.wago.com/231-672



Item no.: 231-670

Insulation stop; 0.08-0.2 mm² / 0.2 mm² "s"; white

www.wago.com/231-670

Subject to changes. Please also observe the further product documentation!

WAGO GmbH & Co. KG

Hansastr. 27

32423 Minden

Phone: +49571 887-0 | Fax: +49571 887-169

Email: info.de@wago.com | Web: www.wago.com

Do you have any questions about our products?

We are always happy to take your call at +49 (571) 887-44222.



Item no.: 231-671
Insulation stop; 0.25 - 0.5 mm²; light gray

www.wago.com/231-671

Cover

Cover



Item no.: 231-668
Lockout caps; for covering unused clamping units; gray

www.wago.com/231-668

Jumpers

Jumper



Item no.: 231-905
Jumper; for conductor entry; 5-way; insulated; gray

www.wago.com/231-905



Item no.: 231-903
Jumper; for conductor entry; 3-way; insulated; gray

www.wago.com/231-903

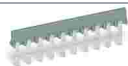

Item no.: 231-907
Jumper; for conductor entry; 7-way; insulated; gray

www.wago.com/231-907











Item no.: 231-902
Jumper; for conductor entry; 2-way; insulated; gray

www.wago.com/231-902

Ferrule

Ferrule

	Item no.: 216-101 Ferrule; Sleeve for 0.5 mm ² / AWG 22; uninsulated; electro-tin plated; silver-colored	www.wago.com/216-101
	Item no.: 216-104 Ferrule; Sleeve for 1.5 mm ² / AWG 16; uninsulated; electro-tin plated; silver-colored	www.wago.com/216-104
	Item no.: 216-106 Ferrule; Sleeve for 2.5 mm ² / AWG 14; uninsulated; electro-tin plated; silver-colored	www.wago.com/216-106
	Item no.: 216-102 Ferrule; Sleeve for 0.75 mm ² / AWG 20; uninsulated; electro-tin plated; silver-colored	www.wago.com/216-102
	Item no.: 216-103 Ferrule; Sleeve for 1 mm ² / AWG 18; uninsulated; electro-tin plated	www.wago.com/216-103
	Item no.: 216-123 Ferrule; Sleeve for 1 mm ² / AWG 18; uninsulated; electro-tin plated; silver-colored	www.wago.com/216-123
	Item no.: 216-122 Ferrule; Sleeve for 0.75 mm ² / AWG 20; uninsulated; electro-tin plated; silver-colored	www.wago.com/216-122
	Item no.: 216-124 Ferrule; Sleeve for 1.5 mm ² / AWG 16; uninsulated; electro-tin plated	www.wago.com/216-124
	Item no.: 216-142 Ferrule; Sleeve for 0.75 mm ² / 18 AWG; uninsulated; electro-tin plated; electrolytic copper; gastight	www.wago.com/216-142











Subject to changes. Please also observe the further product documentation!



crimped; acc. to DIN 46228, Part 1/08.92

	Item no.: 216-132 Ferrule; Sleeve for 0.34 mm ² / AWG 24; uninsulated; electro-tin plated	www.wago.com/216-132
	Item no.: 216-121 Ferrule; Sleeve for 0.5 mm ² / AWG 22; uninsulated; electro-tin plated; silver-colored	www.wago.com/216-121
	Item no.: 216-143 Ferrule; Sleeve for 1 mm ² / AWG 18; uninsulated; electro-tin plated; electrolytic copper; gastight crimped; acc. to DIN 46228, Part 1/08.92	www.wago.com/216-143
	Item no.: 216-131 Ferrule; Sleeve for 0.25 mm ² / AWG 24; uninsulated; electro-tin plated; silver-colored	www.wago.com/216-131
	Item no.: 216-141 Ferrule; Sleeve for 0.5 mm ² / 20 AWG; uninsulated; electro-tin plated; electrolytic copper; gastight crimped; acc. to DIN 46228, Part 1/08.92	www.wago.com/216-141
	Item no.: 216-152 Ferrule; Sleeve for 0.34 mm ² / AWG 24; uninsulated; electro-tin plated	www.wago.com/216-152
	Item no.: 216-203 Ferrule; Sleeve for 1 mm ² / AWG 18; insulated; electro-tin plated; red	www.wago.com/216-203
	Item no.: 216-202 Ferrule; Sleeve for 0.75 mm ² / 18 AWG; insulated; electro-tin plated; gray	www.wago.com/216-202
	Item no.: 216-151 Ferrule; Sleeve for 0.25 mm ² / AWG 24; uninsulated; electro-tin plated	www.wago.com/216-151
	Item no.: 216-204 Ferrule; Sleeve for 1.5 mm ² / AWG 16; insulated; electro-tin plated; black	www.wago.com/216-204
	Item no.: 216-144 Ferrule; Sleeve for 1.5 mm ² / AWG 16; uninsulated; electro-tin plated; electrolytic copper; gastight crimped; acc. to DIN 46228, Part 1/08.92; silver-colored	www.wago.com/216-144
	Item no.: 216-201 Ferrule; Sleeve for 0.5 mm ² / 20 AWG; insulated; electro-tin plated; white	www.wago.com/216-201
	Item no.: 216-223 Ferrule; Sleeve for 1 mm ² / AWG 18; insulated; electro-tin plated; red	www.wago.com/216-223
	Item no.: 216-241 Ferrule; Sleeve for 0.5 mm ² / 20 AWG; insulated; electro-tin plated; electrolytic copper; gastight crimped; acc. to DIN 46228, Part 4/09.90; white	www.wago.com/216-241
	Item no.: 216-242 Ferrule; Sleeve for 0.75 mm ² / 18 AWG; insulated; electro-tin plated; electrolytic copper; gastight crimped; acc. to DIN 46228, Part 4/09.90; gray	www.wago.com/216-242
	Item no.: 216-222 Ferrule; Sleeve for 0.75 mm ² / 18 AWG; insulated; electro-tin plated; gray	www.wago.com/216-222
	Item no.: 216-221 Ferrule; Sleeve for 0.5 mm ² / 20 AWG; insulated; electro-tin plated; white	www.wago.com/216-221

Subject to changes. Please also observe the further product documentation!

	Item no.: 216-224 Ferrule; Sleeve for 1.5 mm ² / AWG 16; insulated; electro-tin plated; black	www.wago.com/216-224
	Item no.: 216-243 Ferrule; Sleeve for 1 mm ² / AWG 18; insulated; electro-tin plated; electrolytic copper; gastight crimped; acc. to DIN 46228, Part 4/09.90; red	www.wago.com/216-243
	Item no.: 216-244 Ferrule; Sleeve for 1.5 mm ² / AWG 16; insulated; electro-tin plated; electrolytic copper; gastight crimped; acc. to DIN 46228, Part 4/09.90; black	www.wago.com/216-244
	Item no.: 216-263 Ferrule; Sleeve for 1 mm ² / AWG 18; insulated; electro-tin plated; electrolytic copper; gastight crimped; acc. to DIN 46228, Part 4/09.90; red	www.wago.com/216-263
	Item no.: 216-264 Ferrule; Sleeve for 1.5 mm ² / AWG 16; insulated; electro-tin plated; electrolytic copper; gastight crimped; acc. to DIN 46228, Part 4/09.90; black	www.wago.com/216-264
	Item no.: 216-262 Ferrule; Sleeve for 0.75 mm ² / 18 AWG; insulated; electro-tin plated; electrolytic copper; gastight crimped; acc. to DIN 46228, Part 4/09.90; gray	www.wago.com/216-262
	Item no.: 216-301 Ferrule; Sleeve for 0.25 mm ² / AWG 24; insulated; electro-tin plated; yellow	www.wago.com/216-301
	Item no.: 216-321 Ferrule; Sleeve for 0.25 mm ² / AWG 24; insulated; electro-tin plated; yellow	www.wago.com/216-321
	Item no.: 216-322 Ferrule; Sleeve for 0.34 mm ² / 22 AWG; insulated; electro-tin plated; light turquoise	www.wago.com/216-322
	Item no.: 216-302 Ferrule; Sleeve for 0.34 mm ² / 22 AWG; insulated; electro-tin plated; light turquoise	www.wago.com/216-302

Marking accessories

Marking strip

	Item no.: 210-331/500-103 Marking strips; as a DIN A4 sheet; MARKED; 1-12 (300x); Height of marker strip: 2.3 mm/0.091 in; Strip length 182 mm; Horizontal marking; Self-adhesive; white	www.wago.com/210-331/500-103
	Item no.: 210-331/500-104 Marking strips; as a DIN A4 sheet; MARKED; 13-24 (300x); Height of marker strip: 2.3 mm/0.091 in; Strip length 182 mm; Horizontal marking; Self-adhesive; white	www.wago.com/210-331/500-104
	Item no.: 210-332/500-202 Marking strips; as a DIN A4 sheet; MARKED; 1-16 (160x); Height of marker strip: 3 mm; Strip length 182 mm; Horizontal marking; Self-adhesive; white	www.wago.com/210-332/500-202
	Item no.: 210-332/500-206 Marking strips; as a DIN A4 sheet; MARKED; 33-48 (160x); Height of marker strip: 3 mm; Strip length 182 mm; Horizontal marking; Self-adhesive; white	www.wago.com/210-332/500-206
	Item no.: 210-332/500-205 Marking strips; as a DIN A4 sheet; MARKED; 1-32 (80x); Height of marker strip: 3 mm; Strip length 182 mm; Horizontal marking; Self-adhesive; white	www.wago.com/210-332/500-205

Subject to changes. Please also observe the further product documentation!



Item no.: 210-332/500-204

Marking strips; as a DIN A4 sheet; MARKED; 17-32 (160x); Height of marker strip: 3 mm; Strip length 182 mm; Horizontal marking; Self-adhesive; white

www.wago.com/210-332/500-204

Tool

Operating tool



Item no.: 209-130

Operating tool; made of insulating material; 1-way; for 264 Series (1-/2-way), 280, 281 Series (up to 3-way); natural

www.wago.com/209-130



Item no.: 209-132

Operating tool; for connecting comb-style jumper bar; made of insulating material; 2-way; natural

www.wago.com/209-132



Item no.: 231-159

Operating tool; natural

www.wago.com/231-159



Item no.: 210-250

Operating tool; for MCS MINI and MIDI with CAGE CLAMP® connection; red

www.wago.com/210-250



Item no.: 231-231

Combination operating tool; red

www.wago.com/231-231



Item no.: 210-657

Operating tool; Blade: 3.5 x 0.5 mm; with a partially insulated shaft; short; multicoloured

www.wago.com/210-657



Item no.: 210-720

Operating tool; Blade: 3.5 x 0.5 mm; with a partially insulated shaft; multicoloured

www.wago.com/210-720



Item no.: 231-131

Operating tool; made of insulating material; 1-way; loose; white

www.wago.com/231-131



Item no.: 231-291

Operating tool; made of insulating material; 1-way; loose; red

www.wago.com/231-291



Item no.: 280-432

Operating tool; made of insulating material; 2-way; white

www.wago.com/280-432



Item no.: 280-434

Operating tool; made of insulating material; 4-way

www.wago.com/280-434



Item no.: 280-437

Operating tool; made of insulating material; 7-way

www.wago.com/280-437



Item no.: 280-435

Operating tool; made of insulating material; 5-way; gray

www.wago.com/280-435

Subject to changes. Please also observe the further product documentation!

WAGO GmbH & Co. KG

Hansastr. 27

32423 Minden

Phone: +49571 887-0 | Fax: +49571 887-169

Email: info.de@wago.com | Web: www.wago.com

Do you have any questions about our products?

We are always happy to take your call at +49 (571) 887-44222.



Item no.: 280-436
Operating tool; made of insulating material; 6-way

www.wago.com/280-436



Item no.: 280-433
Operating tool; made of insulating material; 3-way

www.wago.com/280-433

Downloads

Documentation

Additional Information

Technical Section Technical explanations	2019 Apr 3	pdf 2.1 MB	Download
---	------------	---------------	----------

CAD/CAE-Data

CAE data

EPLAN Data Portal 231-607/019-000	URL	Download
ZUKEN Portal 231-607/019-000	URL	Download
EPLAN Data Portal 231-607/019-000	URL	Download

CAD data

2D/3D Models 231-607/019-000	URL	Download
------------------------------	-----	----------

Asset Administration Shell

Asset Administration Shell 231-607/019-000	URL	Download
--	-----	----------

Environmental Product Compliance

Compliance Search

Environmental Product Compliance 231-607/019-000 1-conductor male connector; CAGE CLAMP®; 2.5 mm ² ; Pin spacing 5 mm; 7-pole; clamping collar; 2,50 mm ² ; gray	URL	Download
--	-----	----------

Installation Notes

Conductor termination

Subject to changes. Please also observe the further product documentation!

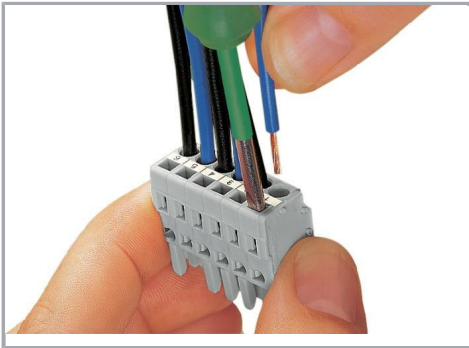

Inserting a conductor via 3.5 mm screwdriver – CAGE CLAMP® actuation parallel to conductor entry.

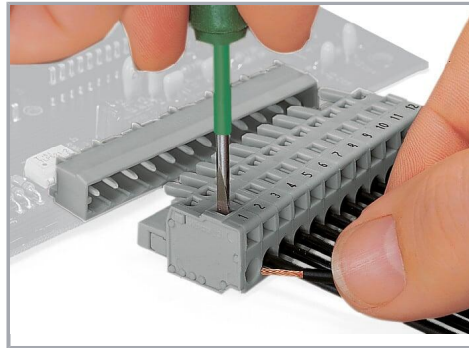

Inserting a conductor via 3.5 mm screwdriver – CAGE CLAMP® actuation perpendicular to conductor entry.

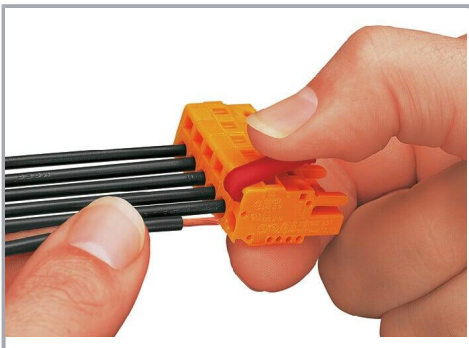

Inserting a conductor into CAGE CLAMP® unit via operating tool (231-291).



Inserting a conductor via operating tool.

Coding

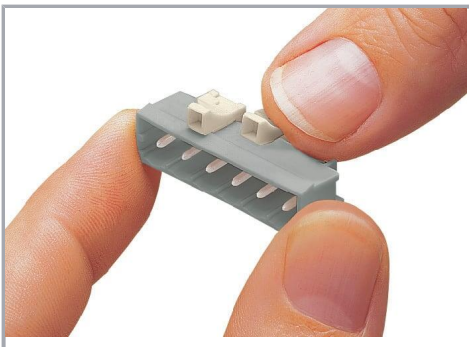

Coding a male header – fitting coding key(s).

Testing

Subject to changes. Please also observe the further product documentation!



Testing – female connector with CAGE CLAMP®

Integrated test ports for testing perpendicular to conductor entry via 2 or 2.3 mm Ø test plug

Installation



Male connector with strain relief plate



Strain relief housing shown with a male connector equipped with CAGE CLAMP®

Marking



Labeling via direct marking or self-adhesive strips.

Product family

Subject to changes. Please also observe the further product documentation!



MCS MIDI Classic

[Show all products from the family](#)

Subject to changes. Please also observe the further product documentation!

WAGO GmbH & Co. KG

Hansastr. 27

32423 Minden

Phone: +49571 887-0 | Fax: +49571 887-169

Email: info.de@wago.com | Web: www.wago.com

Do you have any questions about our products?

We are always happy to take your call at +49 (571) 887-44222.