

Data sheet | Item number: 770-214
Plug; 4-pole; Cod. A; 4,00 mm²; black

www.wago.com/770-214

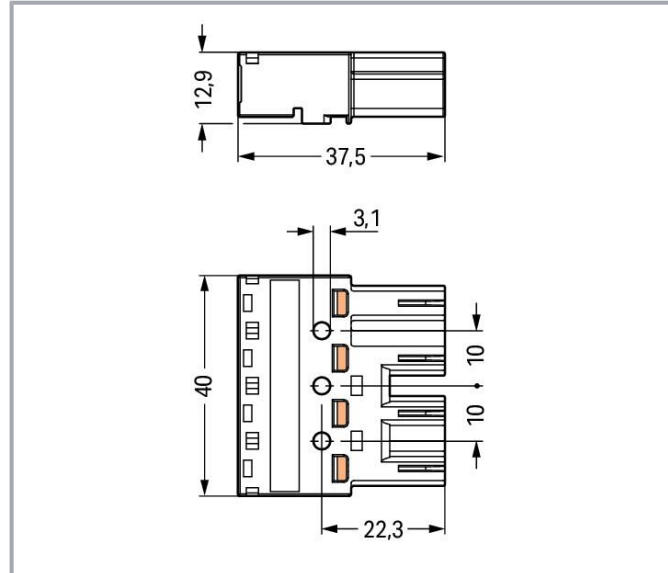

Item description

Male connector/plug *WINSTA*® MIDI with protection type IP20

For signal and power transmission: The *WINSTA*® MIDI male connector/plug rated current 25 A. The pluggable installation connectors with spring pressure connection technology work without screw connections. They allow flexible, error-free installation in a large number of applications. The coding options reduce installation errors, allowing fast, maintenance-free wiring of all components. The pluggable installation connector is protected against ingress by solid objects in accordance with protection type IP20 (When mated and secured with a strain relief housing: IP2xC (These compact connectors are not designed for use in open, easily accessible areas!)). General mains applications for almost any domain of use can be realised with *WINSTA*® MIDI pluggable installation connectors with A coding. This pluggable installation connector is designed for a voltage load of up to 25 A. Thus, it can also be used for high power loads. *WINSTA*® MIDI with Push-in CAGE CLAMP® spring pressure connection technology is found in a broad range of individual products you can use for quick, easy and maximally flexible electrical installation.

Push-in CAGE CLAMP® spring pressure connection technology – pluggable installation instead of laborious screw connections!

The *WINSTA*® Pluggable Connection System is perfectly tailored to the very strict requirements of building installation. It makes electrical installation pluggable, and therefore faster, even more reliable, and error-free. Using this pre-assembled system reduces time spent on assembly

Subject to changes. Please also observe the further product documentation!

WAGO GmbH & Co. KG
Hansastr. 27
32423 Minden
Phone: +49571 887-0 | Fax: +49571 887-169
Email: info.de@wago.com | Web: www.wago.com

Do you have any questions about our products?
We are always happy to take your call at +49 (571) 887-44222.



and errors during installation at the construction site. Enjoy the benefits of the pluggable version of our maintenance-free spring pressure connection technology too! Plan your installation with with protection against mismatching from WAGO.

-
- protection against mismatching eliminates errors
- simple circuits
- suitable for any application
- ready to install and use immediately
- convenient installation and commissioning

Data

Electrical data

Ratings per IEC/EN

Ratings per	IEC/EN 60664-1
Nominal voltage (III/3)	400 V
Rated impulse voltage (III/3)	6 kV
Rated current	25 A
Legend (ratings)	(III / 3) ≙ Overvoltage category III / Pollution degree 3

Ratings per UL 1977

Note for the US market	Some versions may also be used for current interruption in accordance with the UL certificate in select applications with currents below 16 A and voltages up to 600 V. For further information, please contact your local sales office.
Rated voltage (UL 1977)	600 V
Rated current UL 1977	23 A

General information

Note on contact resistance	approx. 1 mΩ of contact resistance approx. 0.25 mΩ contact transition plug/socket
----------------------------	--

Connection data

Connection points	8
Total number of potentials	4
PE function	Preceding PE contact

Subject to changes. Please also observe the further product documentation!



Connection 1

Connection technology	Push-in CAGE CLAMP®
Actuation type	Operating tool Push-in
Nominal cross-section	4 mm ² / 12 AWG
Solid conductor	0.5 ... 4 mm ² / 20 ... 12 AWG
Solid conductor; push-in termination	1.5 ... 4 mm ² / 16 ... 12 AWG
Stranded conductor	0.5 ... 2.5 mm ² / 20 ... 14 AWG
Fine-stranded conductor	0.5 ... 4 mm ² / 20 ... 12 AWG
Fine-stranded conductor; with insulated ferrule	0.25 ... 1.5 mm ² / 20 ... 16 AWG
Fine-stranded conductor; with uninsulated ferrule	0.25 ... 2.5 mm ² / 20 ... 14 AWG
Fine-stranded conductor; with ferrule; push-in termination	1.5 mm ² / 16 AWG
Strip length	9 mm / 0.35 inches
Pole number	4
Conductor entry direction to mating direction	0°

Physical data

Pin spacing	10 mm / 0.394 inches
Width	30 mm / 1.181 inches
Height	12.9 mm / 0.508 inches
Depth	37.5 mm / 1.476 inches

Mechanical Data

Application	General mains applications
Coding	A
Variable coding	Yes
Marking	1/L' 2/L' $\frac{1}{2}$ N
Potential marking	1/L' 2/L' $\frac{1}{2}$ N
Mating force of a plug-in connection	approx. 20 ... 70 N (depending on pole number)
Retention force of a plug-in connection	Locked: > 80 N
Unmating force of a plug-in connection	Unlocked: approx. 20 ... 70 N (depending on pole number)
Number of mating cycles	200, without resistive load
Protection type	IP20; When mated and secured with a strain relief housing: IP2xC (These compact connectors are not designed for use in open, easily accessible areas!)

Subject to changes. Please also observe the further product documentation!



Plug-in connection

Contact type (pluggable connector)	Male connector/plug
Connector (connection type)	for conductor
Mismating protection	Yes
Note on mismating protection	All <i>WINSTA</i> [®] components are 100% protected against mismating when: a.) plugging different numbers of poles b.) plugging while rotated 180 c.) plugging while laterally staggered d.) plugging one pole
Locking lever	Can be retrofitted
Locking of plug-in connection	locking lever
Note on locking system	All connectors for mounted installations (snap-in versions for lighting fixtures or devices, all types of PCB and distribution connectors) are factory-equipped with locking levers to ensure plugs and sockets are securely locked. Additional locking levers are only required for flying leads (plug/socket).

Material data

Note (material data)	Information on material specifications can be found here
Color	black
Cover color	gray
Material group	I
Insulation material	Polyamide (PA66)
Flammability class per UL94	V0
Clamping spring material	Chrome-nickel spring steel (CrNi)
Contact material	Copper or copper alloy; surface-treated
Contact plating	Tin
Fire load	0.258 MJ
Weight	12.9 g

Environmental requirements

Processing temperature	-5 ... +40 °C
Continuous operating temperature	-35 ... +85 °C
Note on continuous operating temperature	Insulating parts for temperatures ≤ 105 °C

Subject to changes. Please also observe the further product documentation!

WAGO GmbH & Co. KG
Hansastr. 27
32423 Minden
Phone: +49571 887-0 | Fax: +49571 887-169
Email: info.de@wago.com | Web: www.wago.com

Do you have any questions about our products?
We are always happy to take your call at +49 (571) 887-44222.

Commercial data



Product Group	20 (Winsta)
eCl@ss 10.0	27-44-06-05
eCl@ss 9.0	27-44-06-05
ETIM 8.0	EC002560
ETIM 7.0	EC002560
ECCN	NO DATA
PU (SPU)	50 pcs
Packaging type	box
Country of origin	DE
GTIN	4044918254519
Customs tariff number	85366990990

Environmental Product Compliance

RoHS Compliance Status	Compliant, No Exemption
------------------------	-------------------------

Approvals / Certificates

General approvals













Logo	Approval	Additional Approval Text	Certificate name
	cURus Underwriters Laboratories Inc.	UL 1977	E45171
	cURus Underwriters Laboratories Inc.	UL 1059	E 45172
	VDE VDE Prüf- und Zertifizierungsinstitut	EN 61984	40002889

Approvals for marine applications

Logo	Approval	Additional Approval Text	Certificate name
	LR Lloyds Register	IEC 61984	LR22429487TA

Subject to changes. Please also observe the further product documentation!

Counterpart

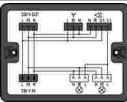
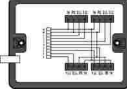
	Item no.770-104 Socket; with strain relief housing; 4-pole; Cod. A; 4,00 mm ² ; black	www.wago.com/770-104
	Item no.770-204 Socket; 4-pole; Cod. A; 4,00 mm ² ; black	www.wago.com/770-204
	Item no.770-627 T-distribution connector; 4-pole; Cod. A; 1 input; 2 outputs; 3 locking levers; for flying leads; black	www.wago.com/770-627
	Item no.770-626 T-distribution connector; 4-pole; Cod. A; 1 input; 2 outputs; 2 locking levers; black	www.wago.com/770-626
	Item no.770-704 Snap-in socket; 4-pole; Cod. A; 4,00 mm ² ; black	www.wago.com/770-704
	Item no.770-704/009-000 Snap-in socket; with protruding mating face; 4-pole; Cod. A; 4,00 mm ² ; black	www.wago.com/770-704/009-000
	Item no.770-804 Socket for PCBs; straight; 4-pole; Cod. A; black	www.wago.com/770-804
	Item no.770-804/011-000 Socket for PCBs; angled; 4-pole; Cod. A; black	www.wago.com/770-804/011-000
	Item no.770-944 h-distribution connector; 4-pole; Cod. A; 1 input; 2 outputs; outputs on one side; 2 locking levers; black	www.wago.com/770-944
	Item no.770-945 h-distribution connector; 4-pole; Cod. A; 1 input; 2 outputs; outputs on one side; 3 locking levers; for flying leads; black	www.wago.com/770-945
	Item no.771-9994/006-101 pre-assembled interconnecting cable; Eca; Socket/plug; 4-pole; Cod. A; H05VV-F 4G 1.5 mm ² ; 1 m; 1,50 mm ² ; black	www.wago.com/771-9994/006-101
	Item no.771-9994/106-101 pre-assembled connecting cable; Eca; Socket/open-ended; 4-pole; Cod. A; H05VV-F 4G 1.5 mm ² ; 1 m; 1,50 mm ² ; black	www.wago.com/771-9994/106-101
	Item no.899-631/180-000 Distribution box; Motion/presence detector; 1 input; 5 outputs; Cod. A; MIDI; black	www.wago.com/899-631/180-000
	Item no.899-631/453-000 Distribution box; supply cable entry; 4 outputs; Cod. A; MIDI; black	www.wago.com/899-631/453-000

Subject to changes. Please also observe the further product documentation!

Required accessories

Strain relief

Strain relief housing



Item no.: 770-504/023-000

Strain relief housing; 4-pole; for 2 cables; 5.0 ... 9.0 mm; 55 mm; black

www.wago.com/770-504/023-000



Item no.: 770-514

Strain relief housing; 4-pole; for 2 cables; 9.0 ... 13.0 mm; 55 mm; white

www.wago.com/770-514



Item no.: 770-504

Strain relief housing; 4-pole; for 2 cables; 9.0 ... 13.0 mm; 55 mm; black

www.wago.com/770-504



Item no.: 770-514/023-000

Strain relief housing; 4-pole; for 2 cables; 5.0 ... 9.0 mm; 55 mm; white

www.wago.com/770-514/023-000

Locking levers

Locking system



Item no.: 770-121

Locking lever; for flying leads; for manual operation; white

www.wago.com/770-121



Item no.: 770-131

Locking lever; for flying leads; for tool operation; white

www.wago.com/770-131



Item no.: 770-101

Locking lever; for flying leads; for manual operation; black

www.wago.com/770-101



Item no.: 770-111

Locking lever; for flying leads; for tool operation; black

www.wago.com/770-111

Optional accessories

Marking accessories

Marker



Item no.: 770-450/000-002

Marker card; Plastic; yellow

www.wago.com/770-450/000-002



Item no.: 770-450/000-001

Marker card; Plastic; green

www.wago.com/770-450/000-001



Item no.: 770-450/000-005

Marker card; Plastic; red

www.wago.com/770-450/000-005

Subject to changes. Please also observe the further product documentation!

WAGO GmbH & Co. KG

Hansastr. 27

32423 Minden

Phone: +49571 887-0 | Fax: +49571 887-169

Email: info.de@wago.com | Web: www.wago.com

Do you have any questions about our products?

We are always happy to take your call at +49 (571) 887-44222.



Item no.: 770-450
Marker card; Plastic; white

www.wago.com/770-450



Item no.: 770-450/000-006
Marker card; Plastic; blue

www.wago.com/770-450/000-006



Item no.: 770-450/000-012
Marker card; Plastic; orange

www.wago.com/770-450/000-012

Mounting

Mounting accessories



Item no.: 770-319
Snap-in frame; 4-pole; 1.0 ... 3.0 mm; black

www.wago.com/770-319



Item no.: 770-339
Snap-in frame; 4-pole; 1.0 ... 3.0 mm; white

www.wago.com/770-339

Cover

Cover



Item no.: 770-360
Lockout cap; for plugs; 5-pole; separable; yellow

www.wago.com/770-360



Item no.: 897-2005
Protective cap; Type4; for sockets and plugs; PVC; red

www.wago.com/897-2005

Tool

Operating tool



Item no.: 210-719
Operating tool; Blade: 2.5 x 0.4 mm; with a partially insulated shaft

www.wago.com/210-719

Strain relief

Strain relief housing



Item no.: 770-504/020-000
Strain relief housing; 4-pole; for 1 cable; 11.5 ... 16.5 mm; 71 mm; black

www.wago.com/770-504/020-000

Downloads

Documentation

Bid Text

770-214	2019 Feb 19	xml	Download
---------	-------------	-----	----------

Subject to changes. Please also observe the further product documentation!



X81 - Datei			3.0 kB	
770-214	2015 Jun 8	doc		Download
doc - Datei		24.1 kB		

CAD/CAE-Data

CAD data

2D/3D Models 770-214		URL		Download
----------------------	--	-----	--	----------

CAE data

EPLAN Data Portal 770-214		URL		Download
---------------------------	--	-----	--	----------

WSCAD Universe 770-214		URL		Download
------------------------	--	-----	--	----------

ZUKEN Portal 770-214		URL		Download
----------------------	--	-----	--	----------

Asset Administration Shell

Asset Administration Shell 770-214		URL		Download
------------------------------------	--	-----	--	----------

Environmental Product Compliance

Compliance Search

Environmental Product Compliance 770-214 Plug; 4-pole; Cod. A; 4,00 mm ² ; black		URL		Download
--	--	-----	--	----------

Installation Notes

Conductor termination

Subject to changes. Please also observe the further product documentation!

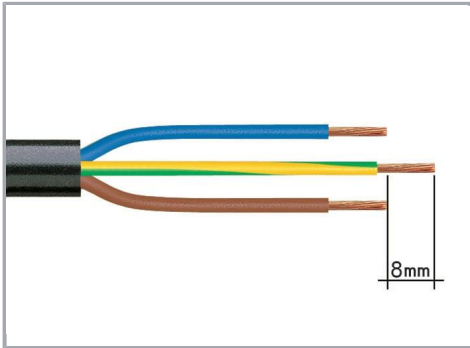

1. Strip length, outer insulation = 35 mm (2-pole), 55 mm (3- to 5-pole)
2. Strip length = 9 mm
3. Extended ground conductor = 8 mm

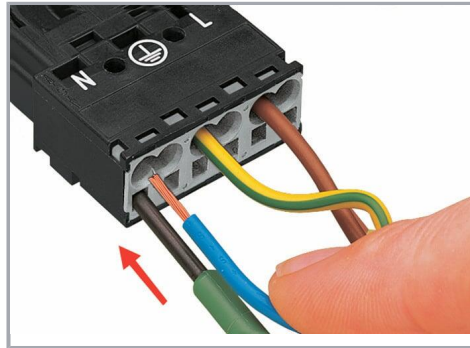

To terminate fine-stranded conductors, open the clamping unit via screwdriver (2.5 mm blade width) and insert a stripped conductor until it hits the backstop.

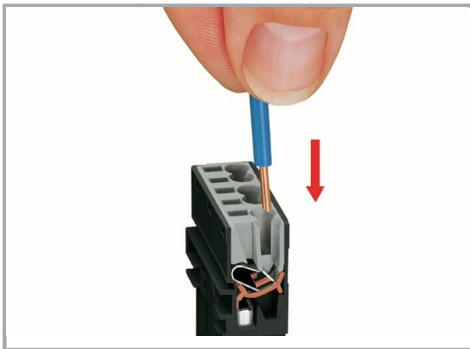

Insert the stripped solid conductor until it hits the backstop.

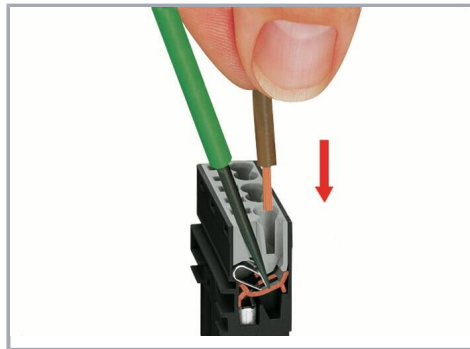

To terminate fine-stranded conductors, open the clamping unit via screwdriver (2.5 mm blade width) and insert a stripped conductor until it hits the backstop.

Conductor removal

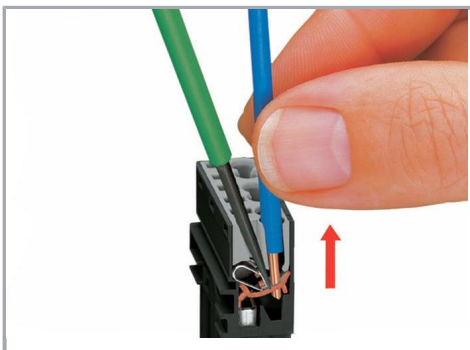

To remove the conductor, actuate the clamp via screwdriver (2.5 mm blade width) and pull out the conductor.

Subject to changes. Please also observe the further product documentation!

Installation

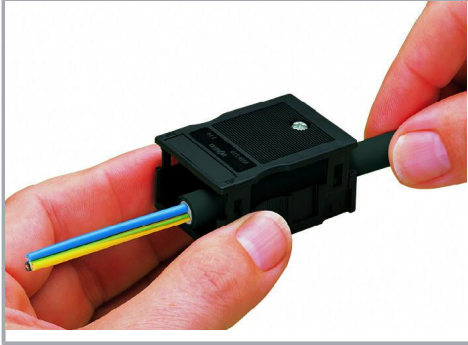

We recommend pulling the pre-latched strain relief housing over the cable prior to termination. However, the strain relief can be mounted at a later time as well.



Latch the strain relief housing onto the plug /socket. Note the "TOP" inscription.



Prepare strain relief housing by snapping together upper and bottom part.



Tighten strain relief screw with screwdriver (2.5 mm blade width).

Product family

WINSTA® MIDI

[Show all products from the family](#)

Subject to changes. Please also observe the further product documentation!