

Data sheet | Item number: 770-1105
Socket; 5-pole; Cod. I; 4,00 mm²; blue

www.wago.com/770-1105

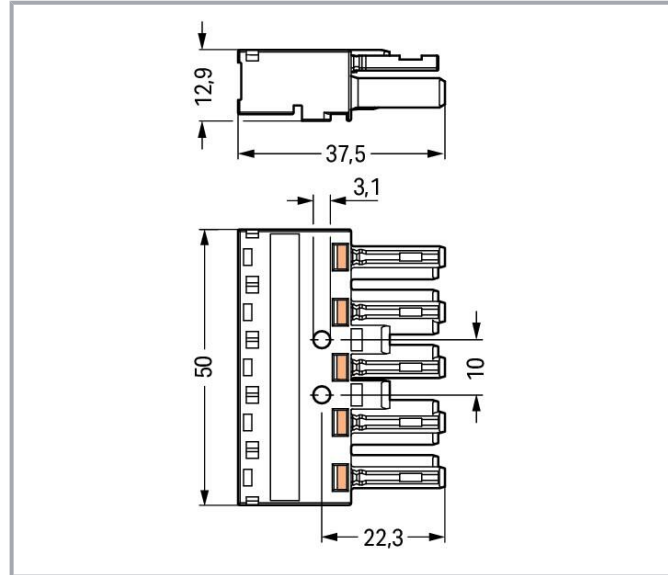
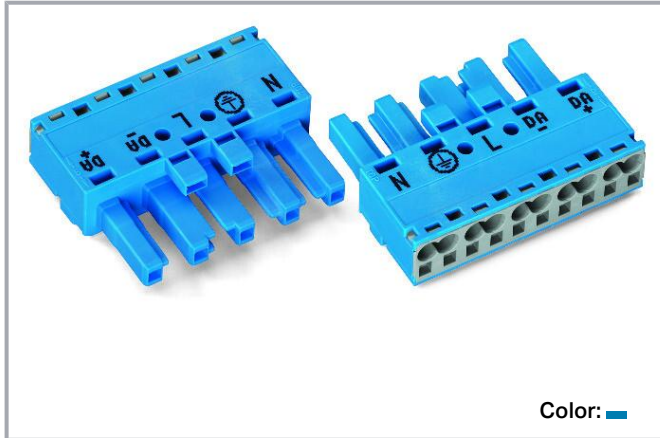

Item description

Female connector/socket *WINSTA*® MIDI I coding

Use effective pluggable connections instead of laborious screw connections: With the *WINSTA*® MIDI female connector/socket with protection type IP20. WAGO pluggable installation connectors are used when specifications repeat or are distributed on a specified pattern, for example for installing grid lighting or flush-mount lighting. The coding options reduce installation errors, allowing fast, secure wiring of all components. The pluggable installation connector is protected in accordance with protection type IP20 (When mated and secured with a strain relief housing: IP2xC (These compact connectors are not designed for use in open, easily accessible areas!)). This means that users' fingers will never come into contact with electrified contact elements. *WINSTA*® MIDI pluggable installation connectors with I coding in blue are above all suitable for lighting management, for example for the dimming of DALI lights. This pluggable installation connector is used for electrical currents up to 25 A. Thus the product is also suitable for high power loads. The *WINSTA*® MIDI Pluggable Connection System with Push-in CAGE CLAMP® spring pressure connection technology facilitates precise electrification. Due to the integrated test slot, connections can be checked even when they are plugged in. This saves time, labor, and money.

Lower costs through fast commissioning and elimination of service expenses – solutions from *WINSTA*® MIDI

WINSTA® is the pluggable connection system that is optimally tailored to the strict requirements of electrical installation. It ensures error-free

Subject to changes. Please also observe the further product documentation!

WAGO GmbH & Co. KG
Hansastr. 27
32423 Minden
Phone: +49571 887-0 | Fax: +49571 887-169
Email: info.de@wago.com | Web: www.wago.com

Do you have any questions about our products?
We are always happy to take your call at +49 (571) 887-44222.



installation of cables and components, quickly and reliably. Choose quality and durability – with marking from WAGO makes the electrical installation of electrical components substantially easier.

- effective protection against mismatching
- simple circuits
- for lighting management
- custom-engineered solutions
- convenient installation and commissioning

Data

Electrical data

Ratings per IEC/EN

Ratings per	IEC/EN 60664-1
Nominal voltage (III/3)	400 V
Rated impulse voltage (III/3)	6 kV
Rated current	25 A
Legend (ratings)	(III / 3) ≙ Overvoltage category III / Pollution degree 3

Ratings per UL 1977

Note for the US market	Some versions may also be used for current interruption in accordance with the UL certificate in select applications with currents below 16 A and voltages up to 600 V. For further information, please contact your local sales office.
Rated voltage (UL 1977)	600 V
Rated current UL 1977	23 A

General information

Note on contact resistance	approx. 1 mΩ of contact resistance approx. 0.25 mΩ contact transition plug/socket
----------------------------	--

Connection data

Connection points	10
Total number of potentials	5

Subject to changes. Please also observe the further product documentation!



Connection 1

Connection technology	Push-in CAGE CLAMP®
Actuation type	Operating tool Push-in
Nominal cross-section	4 mm ² / 12 AWG
Solid conductor	0.5 ... 4 mm ² / 20 ... 12 AWG
Solid conductor; push-in termination	1.5 ... 4 mm ² / 16 ... 12 AWG
Stranded conductor	0.5 ... 2.5 mm ² / 20 ... 14 AWG
Fine-stranded conductor	0.5 ... 4 mm ² / 20 ... 12 AWG
Fine-stranded conductor; with insulated ferrule	0.25 ... 1.5 mm ² / 20 ... 16 AWG
Fine-stranded conductor; with uninsulated ferrule	0.25 ... 2.5 mm ² / 20 ... 14 AWG
Fine-stranded conductor; with ferrule; push-in termination	1.5 mm ² / 16 AWG
Strip length	9 mm / 0.35 inches
Pole number	5
Conductor entry direction to mating direction	0°

Physical data

Pin spacing	10 mm / 0.394 inches
Width	50 mm / 1.969 inches
Height	12.9 mm / 0.508 inches
Depth	37.5 mm / 1.476 inches

Mechanical Data

Application	DALI, Lighting Management
Coding	I
Variable coding	No
Marking	N $\frac{1}{2}$ L DA- DA+
Potential marking	N $\frac{1}{2}$ L DA- DA+
Mating force of a plug-in connection	approx. 20 ... 70 N (depending on pole number)
Retention force of a plug-in connection	Locked: > 80 N
Unmating force of a plug-in connection	Unlocked: approx. 20 ... 70 N (depending on pole number)
Number of mating cycles	200, without resistive load
Protection type	IP20; When mated and secured with a strain relief housing: IP2xC (These compact connectors are not designed for use in open, easily accessible areas!)

Subject to changes. Please also observe the further product documentation!

WAGO GmbH & Co. KG
 Hansastr. 27
 32423 Minden
 Phone: +49571 887-0 | Fax: +49571 887-169
 Email: info.de@wago.com | Web: www.wago.com

Do you have any questions about our products?
 We are always happy to take your call at +49 (571) 887-44222.



Plug-in connection

Contact type (pluggable connector)	Female connector/socket
Connector (connection type)	for conductor
Mismating protection	Yes
Note on mismating protection	All <i>WINSTA</i> [®] components are 100% protected against mismating when: a.) plugging different numbers of poles b.) plugging while rotated 180 c.) plugging while laterally staggered d.) plugging one pole
Locking lever	Can be retrofitted
Locking of plug-in connection	Locking lever
Note on locking system	All connectors for mounted installations (snap-in versions for lighting fixtures or devices, all types of PCB and distribution connectors) are factory-equipped with locking levers to ensure plugs and sockets are securely locked. Additional locking levers are only required for flying leads (plug/socket).

Material data

Note (material data)	Information on material specifications can be found here
Color	blue
Cover color	gray
Material group	I
Insulation material	Polyamide (PA66)
Flammability class per UL94	V0
Clamping spring material	Chrome-nickel spring steel (CrNi)
Contact material	Copper or copper alloy; surface-treated
Contact plating	Tin
Fire load	0.392 MJ
Weight	15.4 g

Environmental requirements

Processing temperature	-5 ... +40 °C
Continuous operating temperature	-35 ... +85 °C
Note on continuous operating temperature	Insulating parts for temperatures ≤ 105 °C

Subject to changes. Please also observe the further product documentation!

WAGO GmbH & Co. KG
Hansastr. 27
32423 Minden
Phone: +49571 887-0 | Fax: +49571 887-169
Email: info.de@wago.com | Web: www.wago.com

Do you have any questions about our products?
We are always happy to take your call at +49 (571) 887-44222.

Commercial data





eCl@ss 10.0	27-44-06-05
eCl@ss 9.0	27-44-06-05
ETIM 8.0	EC002560
ETIM 7.0	EC002560
ECCN	NO DATA
PU (SPU)	50 pcs
Packaging type	Box
Country of origin	DE
GTIN	4044918252706
Customs tariff number	85366990990

Environmental Product Compliance

RoHS Compliance Status	Compliant, No Exemption
------------------------	-------------------------

Approvals / Certificates

General approvals

Logo	Approval	Additional Approval Text	Certificate name
	CCA DEKRA Certification B.V.	EN 61535	71- 123228
	CCA DEKRA Certification B.V.	IEC 61535	NL -84761
	cURus Underwriters Laboratories Inc.	UL 1977	E45171
	cURus Underwriters Laboratories Inc.	UL 1059	E 45172
	VDE VDE Prüf- und Zertifizierungsinstitut	EN 61535	40029808

Declarations of conformity and manufacturer's declarations



Subject to changes. Please also observe the further product documentation!

WAGO GmbH & Co. KG
 Hansastr. 27
 32423 Minden
 Phone: +49571 887-0 | Fax: +49571 887-169
 Email: info.de@wago.com | Web: www.wago.com





Do you have any questions about our products?
 We are always happy to take your call at +49 (571) 887-44222.

Logo	Approval	Additional Approval Text	Certificate name
	EU-Declaration of Conformity WAGO GmbH & Co. KG	-	-

Approvals for marine applications

Logo	Approval	Additional Approval Text	Certificate name
	ABS American Bureau of Shipping	-	19- HG1868589- PDA
	DNV GL Det Norske Veritas, Germanischer Lloyd	-	TAE00001Z6
	LR Lloyds Register	IEC 61984	LR22429487TA

Counterpart

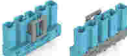
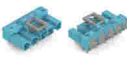
	Item no.770-1115 Plug; 5-pole; 4,00 mm ² ; blue	www.wago.com/770-1115
	Item no.770-1115/022-000 Plug; with strain relief housing; 5-pole; Cod. I; 4,00 mm ² ; blue	www.wago.com/770-1115/022-000
	Item no.770-1947 5-way distribution connector; 5-pole; Cod. I; 1 input; 5 outputs; blue	www.wago.com/770-1947
	Item no.770-2115 Snap-in plug; 5-pole; Cod. I; 4,00 mm ² ; blue	www.wago.com/770-2115
	Item no.770-2115/007-000 Snap-in plug; with direct ground contact; 5-pole; Cod. I; 4,00 mm ² ; blue	www.wago.com/770-2115/007-000
	Item no.770-3115 Plug for PCBs; straight; 5-pole; Cod. I; blue	www.wago.com/770-3115
	Item no.770-3115/011-000 Plug for PCBs; angled; 5-pole; Cod. I; blue	www.wago.com/770-3115/011-000

Subject to changes. Please also observe the further product documentation!



Item no. 770-617
T-distribution connector; 5-pole; Cod. I; 1 input; 2 outputs; 2 locking levers; blue

www.wago.com/770-617



Item no. 770-618
3-way distribution connector; 5-pole; Cod. I; 1 input; 3 outputs; blue

www.wago.com/770-618



Item no. 770-620
T-distribution connector; 5-pole; Cod. I; 1 input; 2 outputs; 3 locking levers; for flying leads; blue

www.wago.com/770-620



Item no. 770-7105
Linect® T-connector; 5-pole; Cod. I; 1 input; 2 outputs; blue

www.wago.com/770-7105



Item no. 770-992
h-distribution connector; 5-pole; Cod. I; 1 input; 2 outputs; outputs on both sides; 2 locking levers; blue

www.wago.com/770-992



Item no. 770-993
h-distribution connector; 5-pole; Cod. I; 1 input; 2 outputs; outputs on both sides; 3 locking levers; for flying leads; blue

www.wago.com/770-993



Item no. 771-9985/006-101
pre-assembled interconnecting cable; Eca; Socket/plug; 5-pole; Cod. I; H05VV-F 5G 1.5 mm²; 1 m; 1,50 mm²; blue

www.wago.com/771-9985/006-101



Item no. 771-9985/206-101
pre-assembled connecting cable; Eca; Plug/open-ended; 5-pole; Cod. I; H05VV-F 5G 1.5 mm²; 1 m; 1,50 mm²; blue

www.wago.com/771-9985/206-101

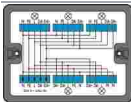

Item no. 899-631/313-000
Distribution box; DALI; 1 input; 5 outputs; Cod. I; MIDI; black

www.wago.com/899-631/313-000

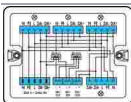

Item no. 899-681/146-000
Distribution box; 230 V + DALI; 1 input; 7 outputs; Cod. I; MINI, MIDI; white

www.wago.com/899-681/146-000

Required accessories

Locking levers

Locking system



Item no.: 770-121
Locking lever; for flying leads; for manual operation; white

www.wago.com/770-121



Item no.: 770-131
Locking lever; for flying leads; for tool operation; white

www.wago.com/770-131

Subject to changes. Please also observe the further product documentation!



Item no.: 770-101

Locking lever; for flying leads; for manual operation; black

www.wago.com/770-101



Item no.: 770-111

Locking lever; for flying leads; for tool operation; black

www.wago.com/770-111

Strain relief

Strain relief housing



Item no.: 770-505/021-000

Strain relief housing; 5-pole; for 1 cable; 11.5 ... 16.5 mm; 71 mm; black

www.wago.com/770-505/021-000



Item no.: 770-505/023-000

Strain relief housing; 5-pole; for 2 cables; 5.0 ... 9.0 mm; 55 mm; black

www.wago.com/770-505/023-000



Item no.: 770-505

Strain relief housing; 5-pole; for 2 cables; 9.0 ... 13.0 mm; 55 mm; black

www.wago.com/770-505



Item no.: 770-515

Strain relief housing; 5-pole; for 2 cables; 9.0 ... 13.0 mm; 55 mm; white

www.wago.com/770-515



Item no.: 770-515/023-000

Strain relief housing; 5-pole; for 2 cables; 5.0 ... 9.0 mm; 55 mm; white

www.wago.com/770-515/023-000



Item no.: 770-515/021-000

Strain relief housing; 5-pole; for 1 cable; 11.5 ... 16.5 mm; 71 mm; white

www.wago.com/770-515/021-000

Optional accessories

Cover

Cover



Item no.: 770-201

Lockout cap; 12-pole, separable; for sockets; Plastic; black

www.wago.com/770-201



Item no.: 770-221

Lockout cap; 12-pole, separable; for sockets; Plastic; white

www.wago.com/770-221



Item no.: 897-2005

Protective cap; Type4; for sockets and plugs; PVC; red

www.wago.com/897-2005

Mounting

Mounting accessories



Item no.: 770-320

Snap-in frame; 5-pole; 1.0 ... 3.0 mm; black

www.wago.com/770-320

Subject to changes. Please also observe the further product documentation!

WAGO GmbH & Co. KG

Hansastr. 27

32423 Minden

Phone: +49571 887-0 | Fax: +49571 887-169

Email: info.de@wago.com | Web: www.wago.com

Do you have any questions about our products?

We are always happy to take your call at +49 (571) 887-44222.



Item no.: 770-321

Snap-in frame; 5-pole; 0.5 ... 2.0 mm; black

www.wago.com/770-321



Item no.: 770-340

Snap-in frame; 5-pole; 1.0 ... 3.0 mm; white

www.wago.com/770-340



Item no.: 770-341

Snap-in frame; 5-pole; 0.5 ... 2.0 mm; white

www.wago.com/770-341

Marking accessories

Marker



Item no.: 770-450/000-002

Marker card; Plastic; yellow

www.wago.com/770-450/000-002



Item no.: 770-450/000-001

Marker card; Plastic; green

www.wago.com/770-450/000-001



Item no.: 770-450/000-005

Marker card; Plastic; red

www.wago.com/770-450/000-005



Item no.: 770-450

Marker card; Plastic; white

www.wago.com/770-450



Item no.: 770-450/000-006

Marker card; Plastic; blue

www.wago.com/770-450/000-006



Item no.: 770-450/000-012

Marker card; Plastic; orange

www.wago.com/770-450/000-012

Tool

Wiring aid



Item no.: 770-100

Wiring aid; 2- to 5-pole; Plastic; orange

www.wago.com/770-100

Operating tool



Item no.: 210-719

Operating tool; Blade: 2.5 x 0.4 mm; with a partially insulated shaft

www.wago.com/210-719

Subject to changes. Please also observe the further product documentation!

WAGO GmbH & Co. KG

Hansastr. 27

32423 Minden

Phone: +49571 887-0 | Fax: +49571 887-169

Email: info.de@wago.com | Web: www.wago.com

Do you have any questions about our products?

We are always happy to take your call at +49 (571) 887-44222.



Downloads

Documentation

Bid Text

770-1105 X81 - Datei	2019 Feb 19	xml 3.0 kB	Download
-------------------------	-------------	---------------	----------

770-1105 doc - Datei	2015 Jun 8	doc 24.1 kB	Download
-------------------------	------------	----------------	----------

ausschreiben.de 770-1105		URL	Download
--------------------------	--	-----	----------

CAD/CAE-Data

CAD data

2D/3D Models 770-1105		URL	Download
-----------------------	--	-----	----------

CAE data

EPLAN Data Portal 770-1105		URL	Download
----------------------------	--	-----	----------

WSCAD Universe 770-1105		URL	Download
-------------------------	--	-----	----------

ZUKEN Portal 770-1105		URL	Download
-----------------------	--	-----	----------

Asset Administration Shell

Asset Administration Shell 770-1105		URL	Download
-------------------------------------	--	-----	----------

Environmental Product Compliance

Compliance Search

Environmental Product Compliance 770-1105 Socket; 5-pole; Cod. I; 4,00 mm ² ; blue		URL	Download
--	--	-----	----------

Installation Notes

Conductor termination

Subject to changes. Please also observe the further product documentation!

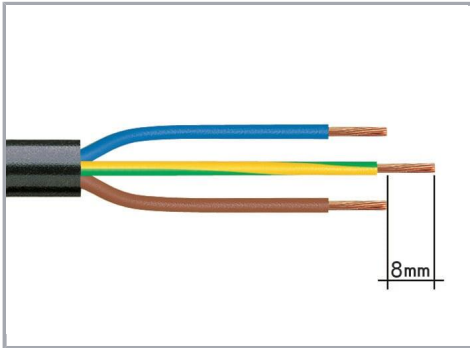

1. Strip length, outer insulation = 35 mm (2-pole), 55 mm (3- to 5-pole)
2. Strip length = 9 mm
3. Extended ground conductor = 8 mm

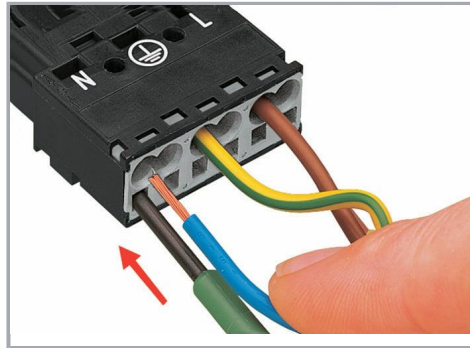

To terminate fine-stranded conductors, open the clamping unit via screwdriver (2.5 mm blade width) and insert a stripped conductor until it hits the backstop.

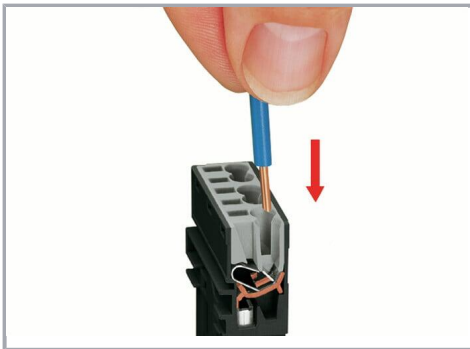

Insert the stripped solid conductor until it hits the backstop.

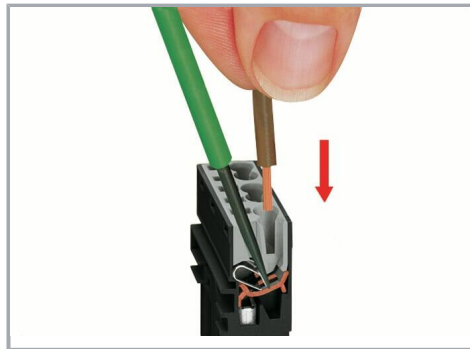

To terminate fine-stranded conductors, open the clamping unit via screwdriver (2.5 mm blade width) and insert a stripped conductor until it hits the backstop.

Conductor removal

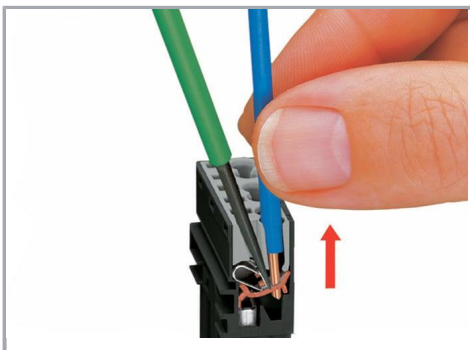

To remove the conductor, actuate the clamp via screwdriver (2.5 mm blade width) and pull out the conductor.

Subject to changes. Please also observe the further product documentation!

Installation

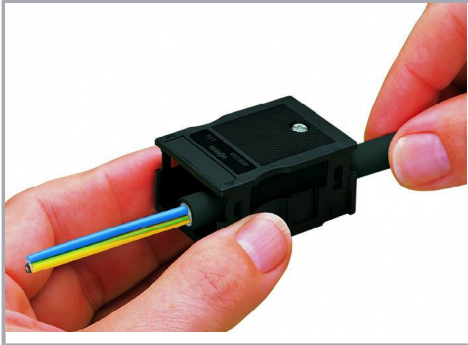

We recommend pulling the pre-latched strain relief housing over the cable prior to termination. However, the strain relief can be mounted at a later time as well.



Latch the strain relief housing onto the plug /socket. Note the "TOP" inscription.

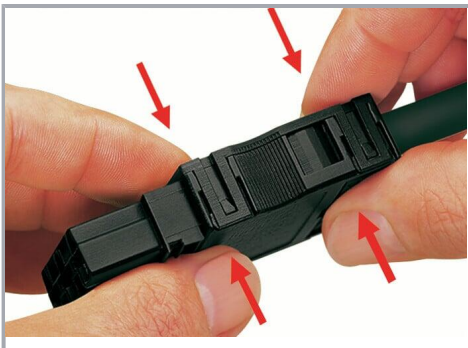

Prepare strain relief housing by snapping together upper and bottom part.



Tighten strain relief screw with screwdriver (2.5 mm blade width).

Product family

WINSTA® MIDI

[Show all products from the family](#)

Subject to changes. Please also observe the further product documentation!