

Data sheet | Item number: 231-364/108-000

THT male header; 1.2 x 1.2 mm solder pin; straight; Threaded flange; Pin spacing 5.08 mm; 4-pole; orange

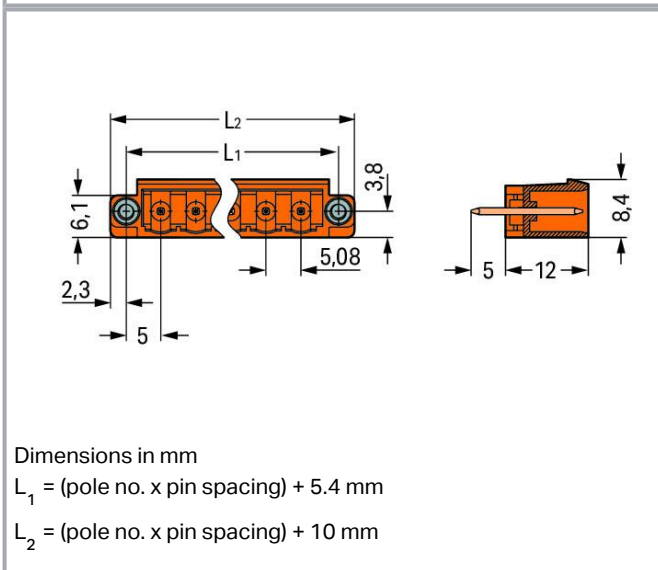

[www.wago.com/231-364/108-000](http://www.wago.com/231-364/108-000)

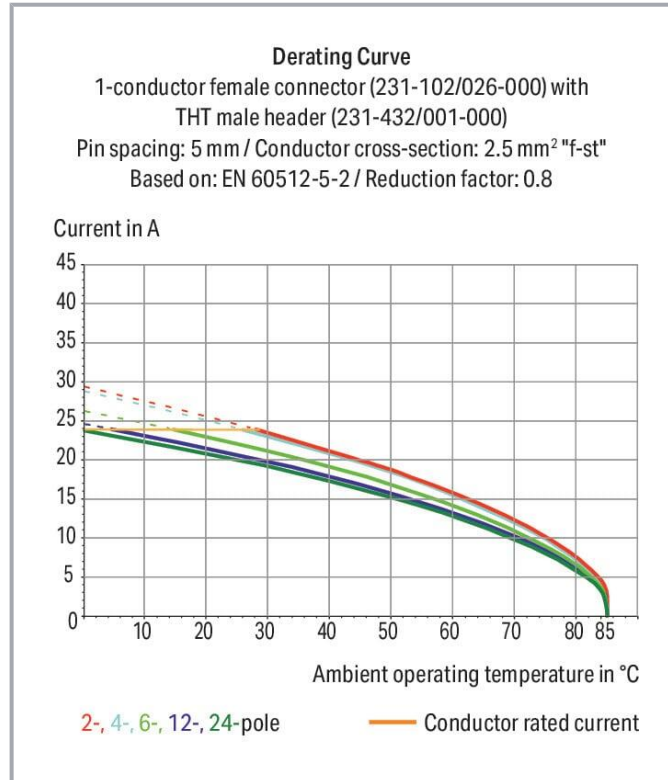
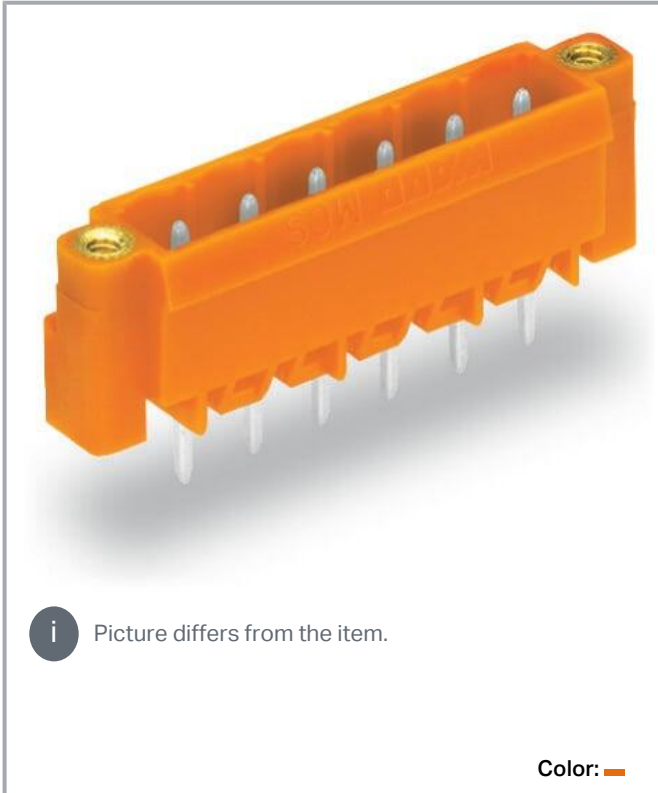

Subject to changes. Please also observe the further product documentation!

WAGO GmbH & Co. KG  
Hansastr. 27  
32423 Minden  
Phone: +49571 887-0 | Fax: +49571 887-169  
Email: [info.de@wago.com](mailto:info.de@wago.com) | Web: [www.wago.com](http://www.wago.com)

Do you have any questions about our products?  
We are always happy to take your call at +49 (571) 887-44222.



## Item description

- Horizontal or vertical PCB mounting via straight or angled solder pins
- 1.2 x 1.2 mm solder pins allow nominal current up to 16 A, enhancing stability of shorter headers
- With coding fingers

## Data

### Notes

#### Safety information

The *MCS – MULTI CONNECTION SYSTEM* includes connectors without breaking capacity in accordance with DIN EN 61984. When used as intended, these connectors must not be connected /disconnected when live or under load. When used as intended, these connectors must not be connected/disconnected when live or under load. The circuit design should ensure header pins, which can be touched, are not live when unmated.

#### Variants:

Other pole numbers  
3.8 mm pin projection for male headers with straight solder pins  
Gold-plated or partially gold-plated contact surfaces  
Other versions (or variants) can be requested from WAGO Sales or configured at <https://configurator.wago.com/>.

## Electrical data

### Ratings per IEC/EN

Ratings per	IEC/EN 60664-1
Nominal voltage (III/3)	250 V
Rated impulse voltage (III/3)	4 kV
Rated voltage (III/2)	320 V
Rated impulse voltage (III/2)	4 kV
Nominal voltage (II/2)	630 V
Rated surge voltage (II/2)	4 kV
Rated current	16 A
Legend (ratings)	(III / 2) ≙ Overvoltage category III / Pollution degree 2

### Ratings per UL

Approvals per	UL 1059
Rated voltage UL (Use Group B)	300 V
Rated current UL (Use Group B)	15 A

Subject to changes. Please also observe the further product documentation!

WAGO GmbH & Co. KG  
Hansastr. 27  
32423 Minden  
Phone: +49571 887-0 | Fax: +49571 887-169  
Email: [info.de@wago.com](mailto:info.de@wago.com) | Web: [www.wago.com](http://www.wago.com)

Do you have any questions about our products?  
We are always happy to take your call at +49 (571) 887-44222.



Rated voltage UL (Use Group D)	300 V
Rated current UL (Use Group D)	10 A

### Ratings per UL 1977

Rated voltage (UL 1977)	600 V
Rated current UL 1977	15 A

### Ratings per CSA

Approvals per	CSA
Rated voltage CSA (Use Group B)	300 V
Rated current CSA (Use Group B)	15 A
Rated voltage CSA (Use Group D)	300 V
Rated current CSA (Use Group D)	10 A

### Connection data

Total number of potentials	4
Number of connection types	1
Number of levels	1

### Connection 1

Pole number	4
-------------	---

### Physical data

Pin spacing	5.08 mm / 0.2 inches
Width	30.32 mm / 1.194 inches
Height	17 mm / 0.669 inches
Height from the surface	12 mm / 0.472 inches
Depth	8.4 mm / 0.331 inches
Solder pin length	5 mm
Solder pin dimensions	1.2 x 1.2 mm
Drilled hole diameter with tolerance	1.7 <sup>(+0.1)</sup> mm

### Mechanical Data

Variable coding	Yes
Anti-rotation protection	Yes

Subject to changes. Please also observe the further product documentation!



## Plug-in connection

Contact type (pluggable connector)	Male connector/plug
Connector (connection type)	for PCB
Mismatching protection	No
Plugging without loss of pin spacing	No
Mating direction to the PCB	90 °
Locking of plug-in connection	Threaded flange

## PCB contact

PCB contact	THT
Solder pin arrangement	over the entire male connector (in-line)
Number of solder pins per potential	1

## Material data

Note (material data)

[Information on material specifications can be found here](#)

Color	orange
Material group	I
Insulation material	Polyamide (PA66)
Flammability class per UL94	V0
Contact material	Electrolytic copper (E <sub>Cu</sub> )
Contact plating	Tin
Fire load	0.037 MJ
Weight	2.3 g

## Environmental requirements

Limit temperature range	-60 ... +100 °C
Processing temperature	-35 ... +60 °C

## Commercial data

Product Group	3 (Multi Conn. System)
eCl@ss 10.0	27-44-04-02
eCl@ss 9.0	27-44-04-02
ETIM 8.0	EC002637
ETIM 7.0	EC002637

Subject to changes. Please also observe the further product documentation!

WAGO GmbH & Co. KG  
 Hansastr. 27  
 32423 Minden  
 Phone: +49571 887-0 | Fax: +49571 887-169  
 Email: [info.de@wago.com](mailto:info.de@wago.com) | Web: [www.wago.com](http://www.wago.com)

Do you have any questions about our products?  
 We are always happy to take your call at +49 (571) 887-44222.



ECCN	NO DATA
PU (SPU)	100 pcs
Packaging type	box
Country of origin	PL
GTIN	4045454845643
Customs tariff number	85366930000

**Environmental Product Compliance**

CAS-No.	7439-92-1
REACH Candidate List Substance	Lead
RoHS Compliance Status	Compliant,With Exemption
RoHS Exemption	6(c)
SCIP notification number (Austria)	d50fefa1-e322-4143-9d6a-717b70421512
SCIP notification number (Belgium)	763e9f60-d76b-4e5f-b2b6-acae082ca266
SCIP notification number (Bulgaria)	171c0d57-1fd2-4dab-8f76-10afab034b61
SCIP notification number (Czech Republic)	5a116de4-e459-498d-97cc-449008318982
SCIP notification number (Denmark)	825ed7fe-c980-44d9-8c48-742861d03ad9
SCIP notification number (Finland)	c4811640-04a3-4e7b-bb1e-e01bcf212438
SCIP notification number (France)	0827e392-fdf5-42a0-842b-8ea73f13d129
SCIP notification number (Germany)	c0d2e051-ce14-4e92-8007-b2fabf50a9af
SCIP notification number (Hungary)	bcc5ba5d-f44a-4c77-90bf-aa8c213ccfbd
SCIP notification number (Italy)	f76c5c04-9fc4-4fd3-b62b-56bace50f55d
SCIP notification number (Netherlands)	48282b5e-6ecb-4fb7-8220-a0e27ce94c6e
SCIP notification number (Poland)	07632257-6161-48c3-8aa9-81b3b624a00b
SCIP notification number (Romania)	32d6deb0-e842-4c58-837c-58614721f81b
SCIP notification number (Sweden)	1b4f17ce-f8a6-4ea3-a2a4-9b7eca7f985c

**Approvals / Certificates****General approvals**

Logo	Approval	Additional Approval Text	Certificate name
	<b>CB</b> DEKRA Certification B.V.	IEC 61984	NL-39756 /A1
	<b>CSA</b> DEKRA Certification B.V.	C22.2	1466354
	<b>KEMA/KEUR</b> DEKRA Certification B.V.	EN 61984	71- 121453

Subject to changes. Please also observe the further product documentation!



	UR Underwriters Laboratories Inc.	UL 1059	E45172
--	--------------------------------------	---------	--------

**Declarations of conformity and manufacturer's declarations**

Logo	Approval	Additional Approval Text	Certificate name
	Railway WAGO GmbH & Co. KG	-	Railway Ready

**Counterpart**





Item no.231-304/107-000

1-conductor female connector; CAGE CLAMP®; 2.5 mm²; Pin spacing 5.08 mm; 4-pole; Screw flange; 2,50 mm²; orange

[www.wago.com/231-304/107-000](http://www.wago.com/231-304/107-000)

**Optional accessories**

Coding			
Intermediate plate			
	Item no.: 231-500 Spacer; for formation of groups; light gray		<a href="http://www.wago.com/231-500">www.wago.com/231-500</a>
Coding			
	Item no.: 231-129 Coding key; snap-on type; light gray		<a href="http://www.wago.com/231-129">www.wago.com/231-129</a>

**Downloads**

**Documentation**

**Additional Information**

Technical Section Technical explanations	2019 Apr 3	pdf 2.1 MB	Download
---	------------	---------------	----------

Subject to changes. Please also observe the further product documentation!

WAGO GmbH & Co. KG  
Hansastr. 27  
32423 Minden  
Phone: +49571 887-0 | Fax: +49571 887-169  
Email: [info.de@wago.com](mailto:info.de@wago.com) | Web: [www.wago.com](http://www.wago.com)

Do you have any questions about our products?  
We are always happy to take your call at +49 (571) 887-44222.



## CAD/CAE-Data

### CAD data

2D/3D Models 231-364/108-000	URL	Download
------------------------------	-----	----------

---

### PCB Design

Symbol and Footprint via Ultra Librarian 231-364/108-000	URL	Download
--	-----	----------

CAX data for your PCB design, consisting of "schematic symbols and PCB footprints", allow easy integration of the WAGO component into your development environment.

### Supported formats:

- Accel EDA 14 & 15
- Altair
- Altium 6 to current version
- Autodesk Fusion 360
- Cadence Allegro
- DesignSpark
- Eagle Libraries
- KiCad
- Mentor Graphics
- BoardStation
- Mentor Graphics Design Architect
- Mentor Graphics Design
- Expedition 99 and 2000
- OrCAD 9.X PCB and Capture
- PADS PowerPCB 3, 3.5, 4.X, and 5.X
- PADS PowerPCB and PowerLogic 3.0
- PCAD 2000, 2001, 2002, 2004, and 2006
- Pulsonix 8.5 or newer
- STL
- 3D STEP
- TARGET 3001!
- View Logic ViewDraw
- Quadcept
- Zuken CadStar 3 and 4
- Zuken CR-5000 and CR-8000
- Zuken eCADSTAR 2020 and 2021 Zuken CR-5000 and CR-8000

Subject to changes. Please also observe the further product documentation!

WAGO GmbH & Co. KG  
Hansastr. 27  
32423 Minden  
Phone: +49571 887-0 | Fax: +49571 887-169  
Email: [info.de@wago.com](mailto:info.de@wago.com) | Web: [www.wago.com](http://www.wago.com)

Do you have any questions about our products?  
We are always happy to take your call at +49 (571) 887-44222.



PCB Component Libraries (EDA), PCB CAD Library Ultra Librarian

---

Symbol and Footprint via SamacSys 231-364/108-000

URL

Download

CAX data for your PCB design, consisting of "schematic symbols and PCB footprints", allow easy integration of the WAGO component into your development environment.

Supported formats:

- 3D (stp)
- Altium
- CADSTAR
- Capture
- CircuitStudio
- CR-5000
- CR-8000
- DEHDL
- DesignSpark PCB
- DesignSpark PCB PRO
- DipTrace
- EAGLE
- Easy-PC
- EasyEDA
- eCADSTAR
- KiCad
- OrCAD\_Allegro16
- PADS
- Proteus
- Pulsonix
- Quadcept
- SOLIDWORKS PCB
- TARGET 3001!
- xDX Designer
- Xpedition

PCB Component Libraries (EDA), PCB CAD Library SamacSys Electronic Component Search Engine

---

**CAE data**

ZUKEN Portal 231-364/108-000

Subject to changes. Please also observe the further product documentation!

---

WAGO GmbH & Co. KG  
Hansastr. 27  
32423 Minden  
Phone: +49571 887-0 | Fax: +49571 887-169  
Email: [info.de@wago.com](mailto:info.de@wago.com) | Web: [www.wago.com](http://www.wago.com)

Do you have any questions about our products?  
We are always happy to take your call at +49 (571) 887-44222.



[URL](#) [Download](#)

### Asset Administration Shell

Asset Administration Shell 231-364/108-000

[URL](#) [Download](#)

### Environmental Product Compliance

#### Compliance Search

Environmental Product Compliance 231-364/108-000

[URL](#) [Download](#)

THT male header; 1.2 x 1.2 mm solder pin; straight; Threaded flange; Pin spacing 5.08 mm; 4-pole; orange

### Installation Notes

#### Coding

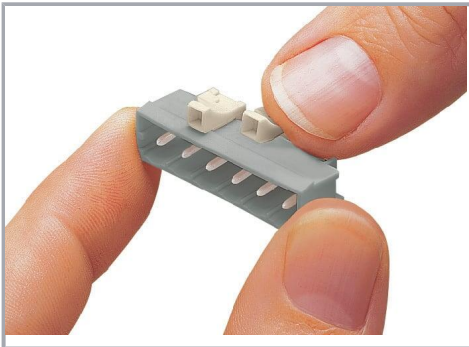

Coding a male header – fitting coding key(s).

### Product family

**MCS MIDI Classic**

[Show all products from the family](#)

Subject to changes. Please also observe the further product documentation!

WAGO GmbH & Co. KG

Hansastr. 27

32423 Minden

Phone: +49571 887-0 | Fax: +49571 887-169

Email: [info.de@wago.com](mailto:info.de@wago.com) | Web: [www.wago.com](http://www.wago.com)

Do you have any questions about our products?

We are always happy to take your call at +49 (571) 887-44222.