

Data sheet | Item number: 890-222

Socket; 2-pole; Cod. A; 1,50 mm<sup>2</sup>; white

[www.wago.com/890-222](http://www.wago.com/890-222)

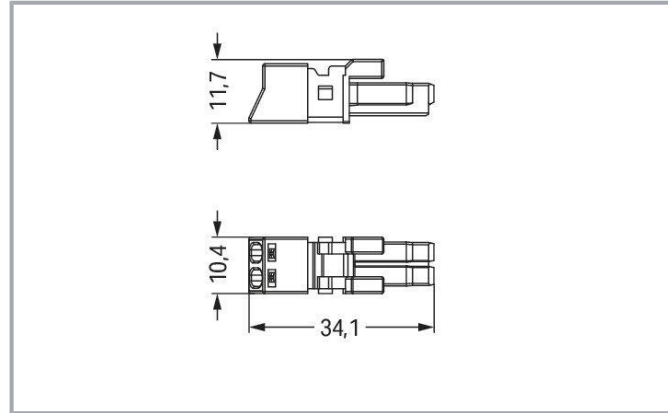
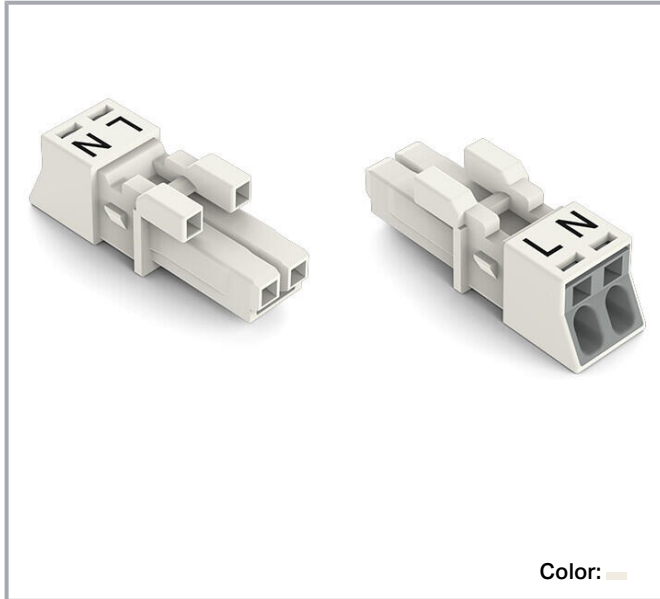

## Item description

### Female connector/socket *WINSTA*® MINI with protection against mismatching

Use effective pluggable connections instead of laborious screw connections: With the *WINSTA*® MINI female connector/socket 2-pole. WAGO pluggable installation connectors are useful when specifications repeat or are distributed on a specific grid, for example for installing grid lighting or flush-mount lighting. The mechanical coding and color coding of the pluggable installation connector ensure error-free installation of the individual components – including protection against mismatching. Thanks to the color coding and mechanical A coding of *WINSTA*® MINI pluggable installation connectors, you can clearly distinguish different circuits. *WINSTA*® MINI satisfies the demand for miniaturisation. Our smallest pluggable connection system is very good for lights, for instance, since as a result of LED technology; due to complex systems, these offer less and less space for the connection technology.

### Push-in *CAGE CLAMP*® spring pressure connection technology – pluggable installation instead of laborious screw connections!

The *WINSTA*® Pluggable Connection System is ideally tailored to the very strict requirements of building installation. It makes electrical installation pluggable, and consequently faster, even more reliable, and error-free. Using this pre-assembled system decreases time spent on assembly and

Subject to changes. Please also observe the further product documentation!

WAGO GmbH & Co. KG  
Hansastr. 27  
32423 Minden  
Phone: +49571 887-0 | Fax: +49571 887-169  
Email: [info.de@wago.com](mailto:info.de@wago.com) | Web: [www.wago.com](http://www.wago.com)

Do you have any questions about our products?  
We are always happy to take your call at +49 (571) 887-44222.



errors during installation at the construction site. Now you can also reduce installation expenses without compromising safety and quality: with marking eliminates the need for servicing and prevents unnecessary downtime.

- effective protection against mismatching
- compact design for conductors with a cross-section up to 1.5 mm<sup>2</sup>
- suitable for any application
- exact dimensions
- convenient installation and commissioning

## Data

### Electrical data

#### Ratings per IEC/EN

Ratings per	IEC/EN 60664-1
Nominal voltage (III/3)	250 V
Rated impulse voltage (III/3)	4 kV
Rated current	16 A
Legend (ratings)	(III / 3) ≙ Overvoltage category III / Pollution degree 3

#### Ratings per UL 1977

Note for the US market	Some versions may also be used for current interruption in accordance with the UL certificate in select applications with currents below 5 A and voltages up to 600 V. For further information, please contact your local sales office.
Rated voltage (UL 1977)	600 V
Rated current UL 1977	14 A

#### General information

Note on contact resistance	approx. 1 mΩ of contact resistance approx. 0.25 mΩ contact transition plug/socket
----------------------------	--

#### Connection data

Connection points	2
Total number of potentials	2

Subject to changes. Please also observe the further product documentation!

## Connection 1

Connection technology	Push-in CAGE CLAMP®
Actuation type	Operating tool Push-in
Nominal cross-section	1.5 mm <sup>2</sup> / 16 AWG
Solid conductor	0.25 ... 1.5 mm <sup>2</sup> / 22 ... 16 AWG
Solid conductor; push-in termination	0.75 ... 1.5 mm <sup>2</sup> / 20 ... 16 AWG
Stranded conductor	0.25 ... 1 mm <sup>2</sup> / 22 ... 18 AWG
Fine-stranded conductor	0.25 ... 1.5 mm <sup>2</sup> / 22 ... 16 AWG
Fine-stranded conductor; with insulated ferrule	0.25 ... 0.75 mm <sup>2</sup> / 22 ... 20 AWG
Fine-stranded conductor; with uninsulated ferrule	0.25 ... 0.75 mm <sup>2</sup> / 22 ... 20 AWG
Fine-stranded conductor; with ferrule; push-in termination	0.75 mm <sup>2</sup> / 20 AWG
Strip length	9 mm / 0.35 inches
Pole number	2
Conductor entry direction to mating direction	0°

## Physical data

Pin spacing	4.4 mm / 0.173 inches
Width	10.4 mm / 0.409 inches
Height	11.7 mm / 0.461 inches
Depth	34.1 mm / 1.343 inches

## Mechanical Data

Application	General mains applications
Coding	A
Variable coding	No
Marking	L N
Potential marking	L N
Mating force of a plug-in connection	approx. 20 ... 70 N (depending on pole number)
Retention force of a plug-in connection	Locked: > 80 N
Unmating force of a plug-in connection	Unlocked: approx. 20 ... 70 N (depending on pole number)
Number of mating cycles	200, without resistive load
Protection type	IP20; IP40 with strain relief housing

Subject to changes. Please also observe the further product documentation!



## Plug-in connection

Contact type (pluggable connector)	Female connector/socket
Connector (connection type)	for conductor
Mismating protection	Yes
Note on mismating protection	All <i>WINSTA</i> <sup>®</sup> components are 100% protected against mismating when: a.) plugging different numbers of poles b.) plugging while rotated 180 c.) plugging while laterally staggered d.) plugging one pole
Locking lever	Can be retrofitted
Locking of plug-in connection	locking lever
Note on locking system	All connectors for mounted installations (snap-in versions for lighting fixtures or devices, all types of PCB and distribution connectors) are factory-equipped with locking levers to ensure plugs and sockets are securely locked. Additional locking levers are only required for flying leads (plug/socket).

## Material data

Note (material data)	Information on material specifications can be found here
Color	white
Cover color	gray
Material group	I
Insulation material	Polyamide (PA66)
Flammability class per UL94	V0
Clamping spring material	Chrome-nickel spring steel (CrNi)
Contact material	Copper or copper alloy; surface-treated
Contact plating	Tin
Fire load	0.058 MJ
Weight	2.6 g

## Environmental requirements

Processing temperature	-5 ... +40 °C
Continuous operating temperature	-35 ... +85 °C
Note on continuous operating temperature	Insulating parts for temperatures ≤ 105 °C

Subject to changes. Please also observe the further product documentation!

WAGO GmbH & Co. KG  
Hansastr. 27  
32423 Minden  
Phone: +49571 887-0 | Fax: +49571 887-169  
Email: [info.de@wago.com](mailto:info.de@wago.com) | Web: [www.wago.com](http://www.wago.com)

Do you have any questions about our products?  
We are always happy to take your call at +49 (571) 887-44222.

## Commercial data



Product Group	20 (Winsta)
eCl@ss 10.0	27-44-06-05
eCl@ss 9.0	27-44-06-05
ETIM 8.0	EC002560
ETIM 7.0	EC002560
ECCN	NO DATA
PU (SPU)	50 pcs
Packaging type	box
Country of origin	PL
GTIN	4055143548465
Customs tariff number	85366990990

## Environmental Product Compliance

RoHS Compliance Status	Compliant, No Exemption
------------------------	-------------------------

## Approvals / Certificates

### General approvals

Logo	Approval	Additional Approval Text	Certificate name
	CCA DEKRA Certification B.V.	EN 61535	71-123231
	CCA DEKRA Certification B.V.	IEC 61535	NL-85020
	cURus Underwriters Laboratories Inc.	UL 1977	E45171

### Declarations of conformity and manufacturer's declarations

Logo	Approval	Additional Approval Text	Certificate name
	EU-Declaration of Conformity WAGO GmbH & Co. KG	-	-
	UK-Declaration of Conformity WAGO GmbH & Co. KG	-	-



Subject to changes. Please also observe the further product documentation!

WAGO GmbH & Co. KG  
 Hansastr. 27  
 32423 Minden  
 Phone: +49571 887-0 | Fax: +49571 887-169  
 Email: [info.de@wago.com](mailto:info.de@wago.com) | Web: [www.wago.com](http://www.wago.com)







Do you have any questions about our products?  
 We are always happy to take your call at +49 (571) 887-44222.



## Approvals for marine applications

Logo	Approval	Additional Approval Text	Certificate name
	<b>ABS</b> American Bureau of Shipping	Steel Vessel Rules	19- HG1869855- PDA
	<b>DNV GL</b> Det Norske Veritas, Germanischer Lloyd	-	TAE00001Z6
	<b>LR</b> Lloyds Register	EN 61535	08/20047 (E2)

## Counterpart

	<b>Item no.890-132</b> Plug; with strain relief housing; 2-pole; 1,50 mm <sup>2</sup> ; white	<a href="http://www.wago.com/890-132">www.wago.com/890-132</a>
	<b>Item no.890-1665</b> T-distribution connector; 2-pole; Cod. A; 1 input; 2 outputs; 3 locking levers; for flying leads; white	<a href="http://www.wago.com/890-1665">www.wago.com/890-1665</a>
	<b>Item no.890-1656</b> T-distribution connector; 2-pole; Cod. A; 1 input; 2 outputs; 2 locking levers; white	<a href="http://www.wago.com/890-1656">www.wago.com/890-1656</a>
	<b>Item no.890-1684</b> h-distribution connector; 2-pole; Cod. A; 1 input; 2 outputs; outputs on one side; 2 locking levers; white	<a href="http://www.wago.com/890-1684">www.wago.com/890-1684</a>
	<b>Item no.890-232</b> Plug; 2-pole; 1,50 mm <sup>2</sup> ; white	<a href="http://www.wago.com/890-232">www.wago.com/890-232</a>
	<b>Item no.890-1686</b> h-distribution connector; 2-pole; Cod. A; 1 input; 2 outputs; outputs on one side; 3 locking levers; for flying leads; white	<a href="http://www.wago.com/890-1686">www.wago.com/890-1686</a>

Subject to changes. Please also observe the further product documentation!



**Item no.890-732**  
Snap-in plug; 2-pole; Cod. A; 1,50 mm<sup>2</sup>; white

[www.wago.com/890-732](http://www.wago.com/890-732)



**Item no.890-832**  
Plug for PCBs; straight; 2-pole; Cod. A; white

[www.wago.com/890-832](http://www.wago.com/890-832)



**Item no.890-832/011-000**  
Plug for PCBs; angled; 2-pole; Cod. A; white

[www.wago.com/890-832/011-000](http://www.wago.com/890-832/011-000)



**Item no.891-8992/005-102**  
pre-assembled interconnecting cable; Eca; Socket/plug; 2-pole; Cod. A; H05VV-F 2 x 1.0 mm<sup>2</sup>; 1 m; 1,00 mm<sup>2</sup>; white

[www.wago.com/891-8992/005-102](http://www.wago.com/891-8992/005-102)



**Item no.891-8992/205-102**  
pre-assembled connecting cable; Eca; Plug/open-ended; 2-pole; Cod. A; H05VV-F 2 x 1.0 mm<sup>2</sup>; 1 m; 1,00 mm<sup>2</sup>; white

[www.wago.com/891-8992/205-102](http://www.wago.com/891-8992/205-102)

## Required accessories

### Strain relief

#### Strain relief housing



**Item no.: 890-502**  
Strain relief housing; 2-pole; with locking clip; for 1 cable; 3.8 ... 8.2 mm; 30 mm; black

[www.wago.com/890-502](http://www.wago.com/890-502)



**Item no.: 890-502/342-000**  
Strain relief housing; 2-pole; with locking clip; for 1 cable; 3.8 ... 8.2 mm; 17.5 mm; black

[www.wago.com/890-502/342-000](http://www.wago.com/890-502/342-000)



**Item no.: 890-512**  
Strain relief housing; 2-pole; with locking clip; for 1 cable; 3.8 ... 8.2 mm; 30 mm; white

[www.wago.com/890-512](http://www.wago.com/890-512)



**Item no.: 890-512/342-000**  
Strain relief housing; 2-pole; with locking clip; for 1 cable; 3.8 ... 8.2 mm; 17.5 mm; white

[www.wago.com/890-512/342-000](http://www.wago.com/890-512/342-000)

### Locking levers

#### Locking system



**Item no.: 890-111**  
Locking lever; for flying leads; for tool operation; black

[www.wago.com/890-111](http://www.wago.com/890-111)



**Item no.: 890-101**  
Locking lever; for manual operation; black

[www.wago.com/890-101](http://www.wago.com/890-101)



**Item no.: 890-121**  
Locking lever; for manual operation; white

[www.wago.com/890-121](http://www.wago.com/890-121)

Subject to changes. Please also observe the further product documentation!



**Item no.: 890-131**  
Locking lever; for flying leads; for tool operation; white

[www.wago.com/890-131](http://www.wago.com/890-131)

## Optional accessories

### Mounting

#### Mounting accessories



**Item no.: 890-310**  
Mounting carrier; 2- to 5-pole; for flying leads; black

[www.wago.com/890-310](http://www.wago.com/890-310)



**Item no.: 890-311**  
Mounting carrier; 2- to 5-pole; for flying leads; white

[www.wago.com/890-311](http://www.wago.com/890-311)

### Cover

#### Cover



**Item no.: 897-2001**  
Protective cap; Type1; for sockets and plugs; PVC; red

[www.wago.com/897-2001](http://www.wago.com/897-2001)

### Tool

#### Operating tool



**Item no.: 210-719**  
Operating tool; Blade: 2.5 x 0.4 mm; with a partially insulated shaft

[www.wago.com/210-719](http://www.wago.com/210-719)



**Item no.: 890-382**  
Operating tool; 2-way; green

[www.wago.com/890-382](http://www.wago.com/890-382)

## Downloads

### Documentation

#### Bid Text

890-222 X81 - Datei	2019 Feb 19	xml 3.0 kB	Download
890-222 doc - Datei	2015 Jun 8	doc 23.0 kB	Download

Subject to changes. Please also observe the further product documentation!

WAGO GmbH & Co. KG  
Hansastr. 27  
32423 Minden  
Phone: +49571 887-0 | Fax: +49571 887-169  
Email: [info.de@wago.com](mailto:info.de@wago.com) | Web: [www.wago.com](http://www.wago.com)

Do you have any questions about our products?  
We are always happy to take your call at +49 (571) 887-44222.



## CAD/CAE-Data

### CAD data

2D/3D Models 890-222	URL	Download

### CAE data

EPLAN Data Portal 890-222	URL	Download

WSCAD Universe 890-222	URL	Download

ZUKEN Portal 890-222	URL	Download

### Asset Administration Shell

Asset Administration Shell 890-222	URL	Download

## Environmental Product Compliance

### Compliance Search

Environmental Product Compliance 890-222	URL	Download
Socket; 2-pole; Cod. A; 1,50 mm <sup>2</sup> ; white		

## Installation Notes

### Conductor termination

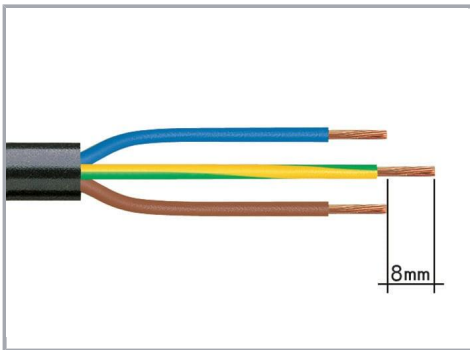

1. Strip length, outer insulation = 30 mm (2-pole), 37 mm (3-pole), 45 mm (4- and 5-pole)
2. Strip length = 9 mm
3. Extended ground conductor = 8 mm

Subject to changes. Please also observe the further product documentation!

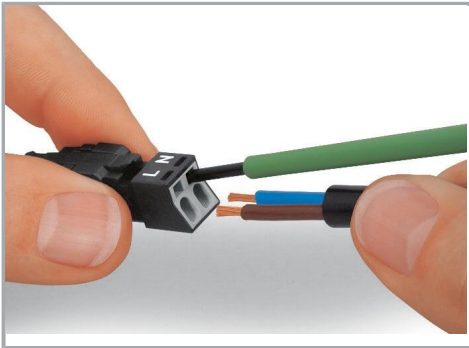

To terminate fine-stranded conductors, open the clamping unit via screwdriver – 2.5 mm blade width – and insert a stripped conductor until it hits the backstop.  
Terminate solid conductors by simply pushing them in.

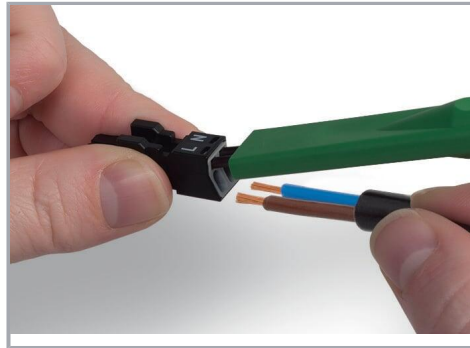

To terminate fine-stranded conductors, open clamping units via operating tool (890-382) and insert stripped conductors until they hit backstop.  
Terminate solid conductors by simply pushing them in.

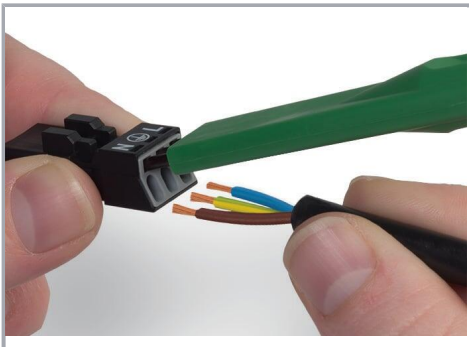

To terminate fine-stranded conductors, open clamping units via operating tool (890-383) and insert stripped conductors until they hit backstop.  
Terminate solid conductors by simply pushing them in.

## Installation

Subject to changes. Please also observe the further product documentation!

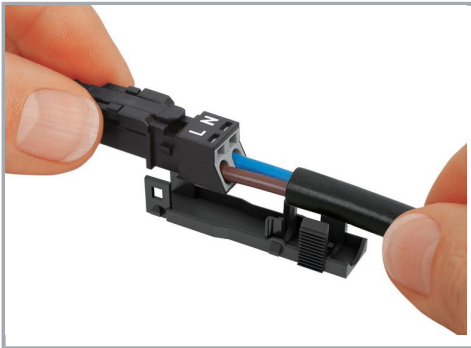

Latch the wired connector into the base of the strain relief housing.

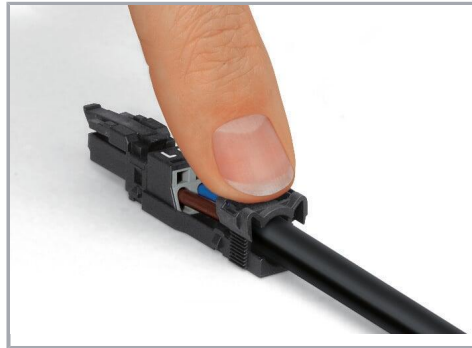

Push down strain relief clamp by hand.



Push down strain relief clamp with 2.5 mm screwdriver alternately on both sides.

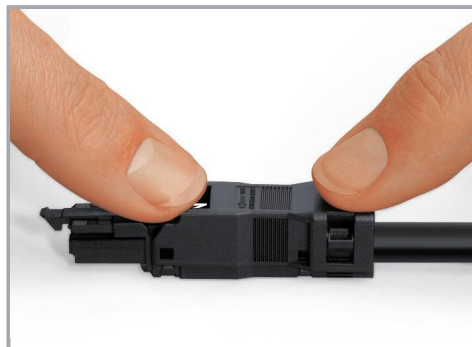

Latch the top of the strain relief housing.

Subject to changes. Please also observe the further product documentation!



The printed marking of the connector is clearly visible in the openings of the strain relief housing.

### Product family

**WINSTA® MINI**

[Show all products from the family](#)

Subject to changes. Please also observe the further product documentation!