

Data sheet | Item number: 770-1324  
Socket; 4-pole; Cod. Q; 4,00 mm<sup>2</sup>; green

[www.wago.com/770-1324](http://www.wago.com/770-1324)

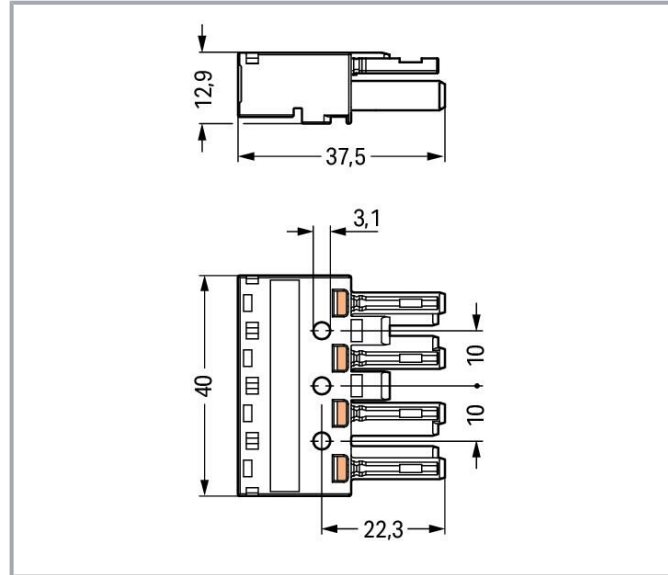
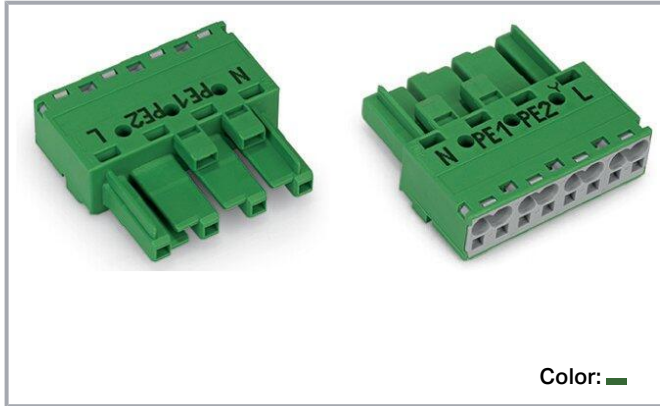

## Item description

### Female connector/socket *WINSTA*® MIDI 4-pole

Use effective pluggable connections instead of laborious screw connections: With the *WINSTA*® MIDI female connector/socket with protection type IP20. The pluggable installation connectors with spring pressure connection technology work without screw connections. They allow resource-efficient, error-free installation in a large number of applications. The color coding and mechanical coding of the pluggable installation connector ensure error-free installation of the individual components – including protection against mismatching. The pluggable installation connector is protected in accordance with protection type IP20 (When mated and secured with a strain relief housing: IP2x0 (These compact connectors are not designed for use in open, easily accessible areas!)). This means that users' fingers will never come into contact with energised elements. This pluggable installation connector can be used for a current load of up to 32 A. As a result, it can also be used for high power loads. The *WINSTA*® MIDI Pluggable Connection System with Push-in CAGE CLAMP® spring pressure connection technology facilitates exemplary electrification. Due to the included test slot, it is possible to check connections even when they are plugged in. That saves time and reduces installation labor and costs.

### Lower costs through fast commissioning and elimination of service expenses – solutions from *WINSTA*® MIDI

*WINSTA*® is the pluggable connection system that is optimally tailored to the strict requirements of electrical installation. It allows fast, secure and, above all, error-free installation of components and cables. Take advantage of the pluggable version of our maintenance-free spring pressure

Subject to changes. Please also observe the further product documentation!

WAGO GmbH & Co. KG  
Hansastr. 27  
32423 Minden  
Phone: +49571 887-0 | Fax: +49571 887-169  
Email: [info.de@wago.com](mailto:info.de@wago.com) | Web: [www.wago.com](http://www.wago.com)

Do you have any questions about our products?  
We are always happy to take your call at +49 (571) 887-44222.



connection technology too! Plan your installation with with protection type IP20 from WAGO.

- 
- effective protection against mismatching
- for automation controllers
- exact dimensions
- quick replacement of defective units during ongoing operation

## Data

### Electrical data

#### Ratings per IEC/EN

Ratings per	IEC/EN 60664-1
Nominal voltage (III/3)	400 V
Rated impulse voltage (III/3)	6 kV
Rated current	32 A
Legend (ratings)	(III / 3) ≙ Overvoltage category III / Pollution degree 3

#### Ratings per UL 1977

Note for the US market	Some versions may also be used for current interruption in accordance with the UL certificate in select applications with currents below 16 A and voltages up to 600 V. For further information, please contact your local sales office.
Rated voltage (UL 1977)	600 V
Rated current UL 1977	23 A

### General information

Note on contact resistance	approx. 1 mΩ of contact resistance approx. 0.25 mΩ contact transition plug/socket
----------------------------	--

### Connection data

Connection points	4
Total number of potentials	4

### Connection 1

Connection technology	Push-in CAGE CLAMP®
-----------------------	---------------------

Subject to changes. Please also observe the further product documentation!



Actuation type	Operating tool Push-in
Nominal cross-section	4 mm <sup>2</sup> / 12 AWG
Solid conductor	0.5 ... 4 mm <sup>2</sup> / 20 ... 12 AWG
Solid conductor; push-in termination	1.5 ... 4 mm <sup>2</sup> / 16 ... 12 AWG
Stranded conductor	0.5 ... 2.5 mm <sup>2</sup> / 20 ... 14 AWG
Fine-stranded conductor	0.5 ... 4 mm <sup>2</sup> / 20 ... 12 AWG
Fine-stranded conductor; with insulated ferrule	0.25 ... 1.5 mm <sup>2</sup> / 20 ... 16 AWG
Fine-stranded conductor; with uninsulated ferrule	0.25 ... 2.5 mm <sup>2</sup> / 20 ... 14 AWG
Fine-stranded conductor; with ferrule; push-in termination	1.5 mm <sup>2</sup> / 16 AWG
Strip length	9 mm / 0.35 inches
Pole number	4
Conductor entry direction to mating direction	0 °

### Physical data

Pin spacing	10 mm / 0.394 inches
Width	40 mm / 1.575 inches
Height	12.9 mm / 0.508 inches
Depth	37.5 mm / 1.476 inches

### Mechanical Data

Application	for "Clean Ground" applications
Coding	Q
Variable coding	No
Marking	N PE1 PE2 L
Potential marking	N PE1 PE2 L
Mating force of a plug-in connection	approx. 20 ... 70 N (depending on pole number)
Retention force of a plug-in connection	Locked: > 80 N
Unmating force of a plug-in connection	Unlocked: approx. 20 ... 70 N (depending on pole number)
Number of mating cycles	200, without resistive load
Protection type	IP20; When mated and secured with a strain relief housing: IP2xC (These compact connectors are not designed for use in open, easily accessible areas!)

### Plug-in connection

Contact type (pluggable connector)	Female connector/socket
Connector (connection type)	for conductor

Subject to changes. Please also observe the further product documentation!



Mismating protection	Yes
Note on mismating protection	All WINSTA <sup>®</sup> components are 100% protected against mismating when: a.) plugging different numbers of poles b.) plugging while rotated 180 c.) plugging while laterally staggered d.) plugging one pole
Locking lever	Can be retrofitted
Locking of plug-in connection	locking lever
Note on locking system	All connectors for mounted installations (snap-in versions for lighting fixtures or devices, all types of PCB and distribution connectors) are factory-equipped with locking levers to ensure plugs and sockets are securely locked. Additional locking levers are only required for flying leads (plug/socket).

## Material data

Note (material data)	Information on material specifications can be found here
Color	green
Cover color	gray
Material group	I
Insulation material	Polyamide (PA66)
Flammability class per UL94	V0
Clamping spring material	Chrome-nickel spring steel (CrNi)
Contact material	Copper or copper alloy; surface-treated
Contact plating	Tin
Fire load	0.221 MJ
Weight	12.6 g

## Environmental requirements

Processing temperature	-5 ... +40 °C
Continuous operating temperature	-35 ... +85 °C
Note on continuous operating temperature	Insulating parts for temperatures ≤ 105 °C

## Commercial data

eCl@ss 10.0	27-44-06-05
eCl@ss 9.0	27-44-06-05
ETIM 8.0	EC002560

Subject to changes. Please also observe the further product documentation!

WAGO GmbH & Co. KG  
Hansastr. 27  
32423 Minden  
Phone: +49571 887-0 | Fax: +49571 887-169  
Email: [info.de@wago.com](mailto:info.de@wago.com) | Web: [www.wago.com](http://www.wago.com)

Do you have any questions about our products?  
We are always happy to take your call at +49 (571) 887-44222.



ETIM 7.0	EC002560
ECCN	NO DATA
PU (SPU)	50 pcs
Packaging type	box
Country of origin	DE
GTIN	4045454299156
Customs tariff number	85366990990

## Environmental Product Compliance

RoHS Compliance Status	Compliant, No Exemption
------------------------	-------------------------

## Approvals / Certificates

### General approvals

Logo	Approval	Additional Approval Text	Certificate name
	CCA DEKRA Certification B.V.	EN 61535	71-123228
	CCA DEKRA Certification B.V.	IEC 61535	NL -84761
	cURus Underwriters Laboratories Inc.	UL 1977	E45171
	cURus Underwriters Laboratories Inc.	UL 1059	E 45172

### Declarations of conformity and manufacturer's declarations

Logo	Approval	Additional Approval Text	Certificate name
	EU-Declaration of Conformity WAGO GmbH & Co. KG	-	-

### Approvals for marine applications

Logo	Approval	Additional Approval Text	Certificate name
------	----------	--------------------------	------------------

Subject to changes. Please also observe the further product documentation!

WAGO GmbH & Co. KG  
Hansastr. 27  
32423 Minden  
Phone: +49571 887-0 | Fax: +49571 887-169  
Email: [info.de@wago.com](mailto:info.de@wago.com) | Web: [www.wago.com](http://www.wago.com)

Do you have any questions about our products?  
We are always happy to take your call at +49 (571) 887-44222.



ABS  
American Bureau of Shipping

-

19-  
HG1868589-  
PDA



DNV GL  
Det Norske Veritas, Germanischer Lloyd

-

TAE00001Z6



LR  
Lloyds Register

IEC 61984

LR22429487TA

## Counterpart



Item no.770-1334  
Plug; 4-pole; Cod. Q; 4,00 mm<sup>2</sup>; green

[www.wago.com/770-1334](http://www.wago.com/770-1334)



Item no.770-2334  
Snap-in plug; 4-pole; Cod. Q; 4,00 mm<sup>2</sup>; green

[www.wago.com/770-2334](http://www.wago.com/770-2334)



Item no.770-2334/007-000  
Snap-in plug; with direct ground contact; 4-pole; Cod. Q; 4,00 mm<sup>2</sup>; green

[www.wago.com/770-2334/007-000](http://www.wago.com/770-2334/007-000)

## Required accessories

### Strain relief

Strain relief housing



Item no.: 770-504/023-000  
Strain relief housing; 4-pole; for 2 cables; 5.0 ... 9.0 mm; 55 mm; black

[www.wago.com/770-504/023-000](http://www.wago.com/770-504/023-000)



Item no.: 770-514  
Strain relief housing; 4-pole; for 2 cables; 9.0 ... 13.0 mm; 55 mm; white

[www.wago.com/770-514](http://www.wago.com/770-514)



Item no.: 770-504  
Strain relief housing; 4-pole; for 2 cables; 9.0 ... 13.0 mm; 55 mm; black

[www.wago.com/770-504](http://www.wago.com/770-504)



Item no.: 770-514/023-000  
Strain relief housing; 4-pole; for 2 cables; 5.0 ... 9.0 mm; 55 mm; white

[www.wago.com/770-514/023-000](http://www.wago.com/770-514/023-000)

### Locking levers

Locking system



Item no.: 770-121  
Locking lever; for flying leads; for manual operation; white

[www.wago.com/770-121](http://www.wago.com/770-121)

Subject to changes. Please also observe the further product documentation!



**Item no.: 770-131**  
Locking lever; for flying leads; for tool operation; white

[www.wago.com/770-131](http://www.wago.com/770-131)



**Item no.: 770-101**  
Locking lever; for flying leads; for manual operation; black

[www.wago.com/770-101](http://www.wago.com/770-101)



**Item no.: 770-111**  
Locking lever; for flying leads; for tool operation; black

[www.wago.com/770-111](http://www.wago.com/770-111)

## Cover

Cover



**Item no.: 770-201**  
Lockout cap; 12-pole, separable; for sockets; Plastic; black

[www.wago.com/770-201](http://www.wago.com/770-201)



**Item no.: 770-221**  
Lockout cap; 12-pole, separable; for sockets; Plastic; white

[www.wago.com/770-221](http://www.wago.com/770-221)

## Optional accessories

### Strain relief

Strain relief housing



**Item no.: 770-504/020-000**  
Strain relief housing; 4-pole; for 1 cable; 11.5 ... 16.5 mm; 71 mm; black

[www.wago.com/770-504/020-000](http://www.wago.com/770-504/020-000)

### Cover

Cover



**Item no.: 897-2005**  
Protective cap; Type4; for sockets and plugs; PVC; red

[www.wago.com/897-2005](http://www.wago.com/897-2005)

### Mounting

Mounting accessories



**Item no.: 770-319**  
Snap-in frame; 4-pole; 1.0 ... 3.0 mm; black

[www.wago.com/770-319](http://www.wago.com/770-319)



**Item no.: 770-339**  
Snap-in frame; 4-pole; 1.0 ... 3.0 mm; white

[www.wago.com/770-339](http://www.wago.com/770-339)

### Tool

Operating tool

Subject to changes. Please also observe the further product documentation!



Item no.: 210-719

Operating tool; Blade: 2.5 x 0.4 mm; with a partially insulated shaft

### Marking accessories

#### Marker



Item no.: 770-450/000-002  
Marker card; Plastic; yellow

[www.wago.com/770-450/000-002](http://www.wago.com/770-450/000-002)



Item no.: 770-450/000-001  
Marker card; Plastic; green

[www.wago.com/770-450/000-001](http://www.wago.com/770-450/000-001)



Item no.: 770-450/000-005  
Marker card; Plastic; red

[www.wago.com/770-450/000-005](http://www.wago.com/770-450/000-005)



Item no.: 770-450  
Marker card; Plastic; white

[www.wago.com/770-450](http://www.wago.com/770-450)



Item no.: 770-450/000-006  
Marker card; Plastic; blue

[www.wago.com/770-450/000-006](http://www.wago.com/770-450/000-006)



Item no.: 770-450/000-012  
Marker card; Plastic; orange

[www.wago.com/770-450/000-012](http://www.wago.com/770-450/000-012)

### Downloads

#### Documentation

##### Bid Text

770-1324 X81 - Datei	2019 Feb 19	xml 3.1 kB	Download
770-1324 doc - Datei	2015 Jun 8	doc 24.1 kB	Download

#### CAD/CAE-Data

##### CAE data

EPLAN Data Portal 770-1324	URL	Download
----------------------------	-----	----------

Subject to changes. Please also observe the further product documentation!



WSCAD Universe 770-1324

[URL](#) [Download](#)

ZUKEN Portal 770-1324

[URL](#) [Download](#)

### CAD data

2D/3D Models 770-1324

[URL](#) [Download](#)

### Asset Administration Shell

Asset Administration Shell 770-1324

[URL](#) [Download](#)

## Environmental Product Compliance

### Compliance Search

Environmental Product Compliance 770-1324

[URL](#) [Download](#)

Socket; 4-pole; Cod. Q; 4,00 mm<sup>2</sup>; green

## Installation Notes

### Conductor termination

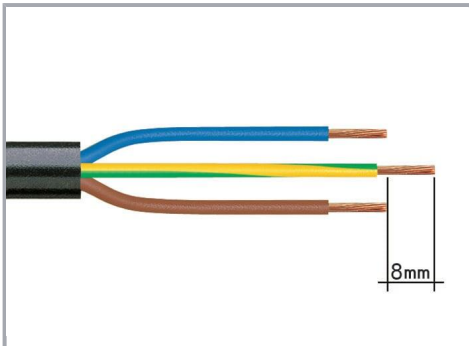

1. Strip length, outer insulation = 35 mm (2-pole), 55 mm (3- to 5-pole)
2. Strip length = 9 mm
3. Extended ground conductor = 8 mm

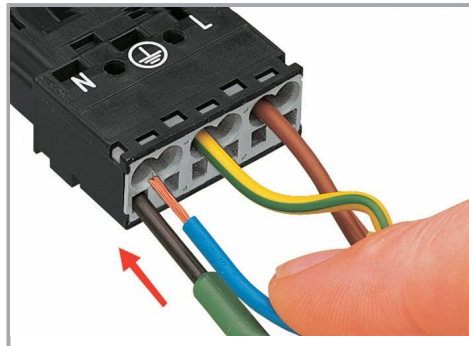

To terminate fine-stranded conductors, open the clamping unit via screwdriver (2.5 mm blade width) and insert a stripped conductor until it hits the backstop.

Subject to changes. Please also observe the further product documentation!

WAGO GmbH & Co. KG

Hansastr. 27

32423 Minden

Phone: +49571 887-0 | Fax: +49571 887-169

Email: [info.de@wago.com](mailto:info.de@wago.com) | Web: [www.wago.com](http://www.wago.com)

Do you have any questions about our products?

We are always happy to take your call at +49 (571) 887-44222.

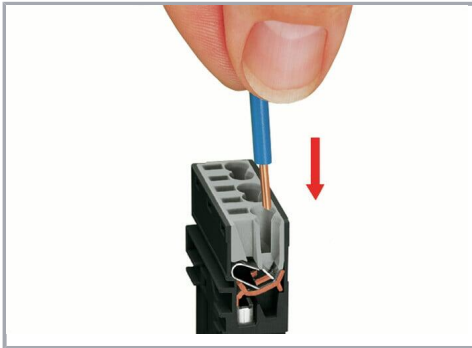

Insert the stripped solid conductor until it hits the backstop.

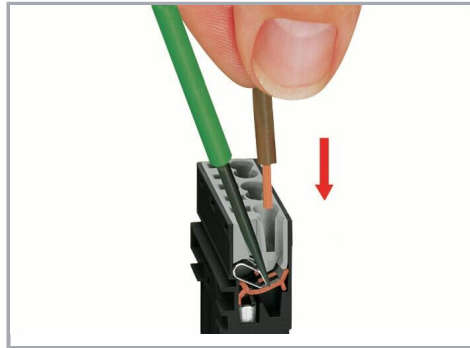

To terminate fine-stranded conductors, open the clamping unit via screwdriver (2.5 mm blade width) and insert a stripped conductor until it hits the backstop.

#### Conductor removal

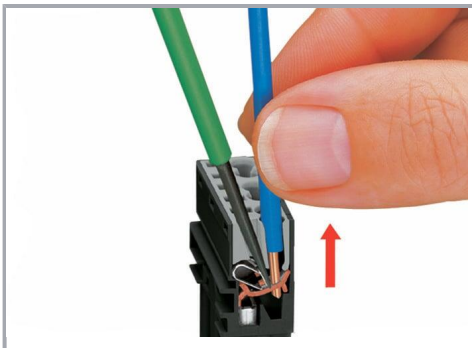

To remove the conductor, actuate the clamp via screwdriver (2.5 mm blade width) and pull out the conductor.

#### Installation

Subject to changes. Please also observe the further product documentation!

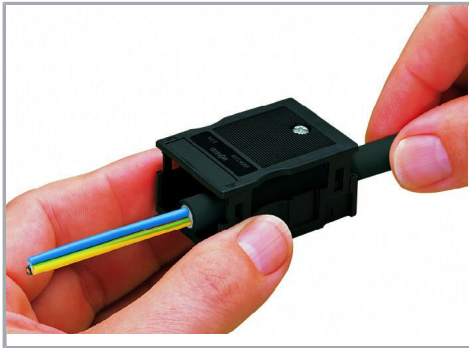

We recommend pulling the pre-latched strain relief housing over the cable prior to termination. However, the strain relief can be mounted at a later time as well.

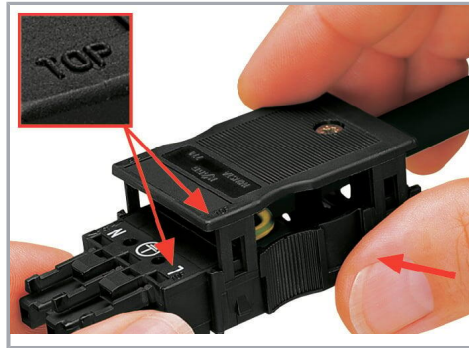

Latch the strain relief housing onto the plug /socket. Note the "TOP" inscription.

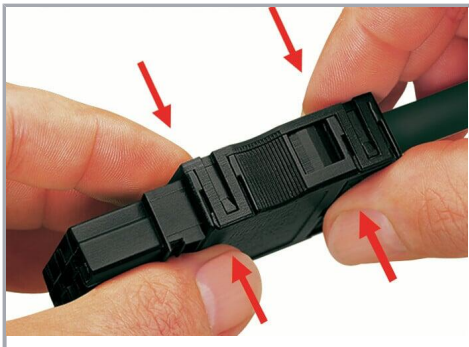

Prepare strain relief housing by snapping together upper and bottom part.



Tighten strain relief screw with screwdriver (2.5 mm blade width).

## Product family

**WINSTA® MIDI**

[Show all products from the family](#)

Subject to changes. Please also observe the further product documentation!