

Data sheet | Item number: 890-2115

Snap-in plug; 5-pole; Cod. I; 1,50 mm²; blue

www.wago.com/890-2115

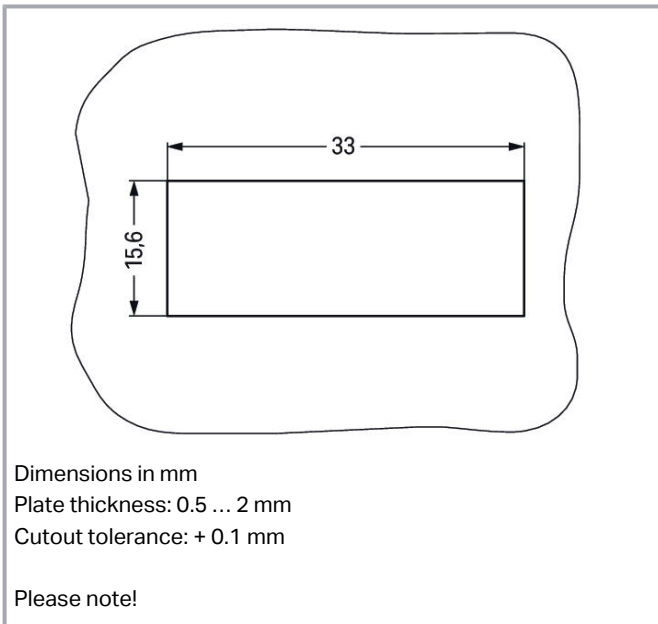
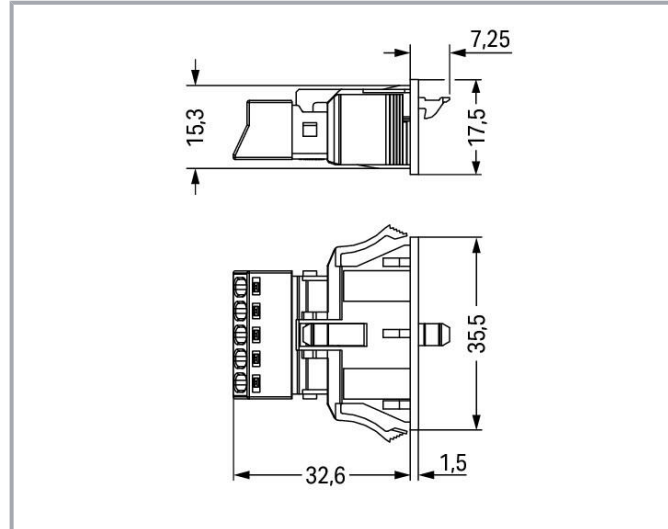
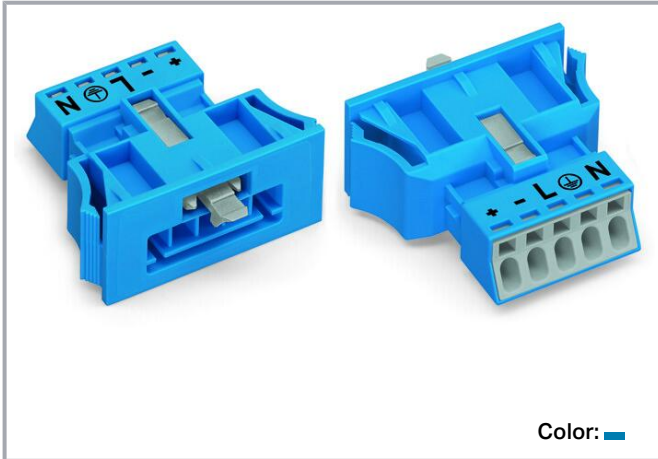

Subject to changes. Please also observe the further product documentation!

WAGO GmbH & Co. KG
Hansastr. 27
32423 Minden
Phone: +49571 887-0 | Fax: +49571 887-169
Email: info.de@wago.com | Web: www.wago.com

Do you have any questions about our products?
We are always happy to take your call at +49 (571) 887-44222.



Item description

Male connector/plug *WINSTA*® MINI I coding

Use effective pluggable connections instead of laborious screw connections: With the *WINSTA*® MINI male connector/plug 5-pole. WAGO pluggable installation connectors are used when specifications repeat or are planned on a defined pattern, for example for installing grid lighting or flush-mount lighting. The coding options reduce installation errors, allowing fast, maintenance-free wiring of all components. I coding in blue is used to mark *WINSTA*® MINI pluggable installation connectors, which are used primarily in automation of buildings for controlling lighting. Thanks to its particularly compact dimensions, our *WINSTA*® MINI Pluggable Connection System with Push-in CAGE CLAMP® spring pressure connection technology is very suitable in very tight spaces, i.e., for installations when very little room is available.

Push-in CAGE CLAMP® spring pressure connection technology – pluggable installation instead of laborious screw connections!

WINSTA® is the pluggable connection system that is optimally tailored to the strict requirements of electrical installation. It allows error-free installation of cables and components, quickly and reliably. Now you can also cut installation costs without compromising quality and safety: with marking reduces the need for servicing and prevents unnecessary downtime.

-
- pluggable installation connectors with protection against mismatching
- easy tool-free operation, a wide range of coding options
- with I coding for controlling light (DALI standard)
- exact dimensions
- rapid, structured electrical installation

Data

Notes

Note	<p>The snap-in connectors must be relieved of tensile and transverse forces.</p> <p>A surface finish can influence the edge radius of the cutouts. This may affect the snap-in socket fit, so ensure an adequate fit before use. In addition, the punched edge should be on the inside for punched cutouts.</p> <p>The wings of the snap-in connectors must not be mechanically stressed for a long period before use (e.g., due to a pre-locking position).</p>
------	--

Subject to changes. Please also observe the further product documentation!



Electrical data

Ratings per IEC/EN

Ratings per	IEC/EN 60664-1
Nominal voltage (III/3)	400 V
Rated impulse voltage (III/3)	6 kV
Rated current	16 A
Legend (ratings)	(III / 3) $\hat{=}$ Overvoltage category III / Pollution degree 3

Ratings per UL 1977

Note for the US market	Some versions may also be used for current interruption in accordance with the UL certificate in select applications with currents below 5 A and voltages up to 600 V. For further information, please contact your local sales office.
Rated voltage (UL 1977)	600 V
Rated current UL 1977	12 A

General information

Note on contact resistance	approx. 1 m Ω of contact resistance approx. 0.25 m Ω contact transition plug/socket
----------------------------	--

Connection data

Connection points	5
Total number of potentials	5
PE function	Preceding PE contact

Connection 1

Connection technology	Push-in CAGE CLAMP [®]
Actuation type	Operating tool Push-in
Nominal cross-section	1.5 mm ² / 16 AWG
Solid conductor	0.25 ... 1.5 mm ² / 22 ... 16 AWG
Solid conductor; push-in termination	0.75 ... 1.5 mm ² / 20 ... 16 AWG
Stranded conductor	0.25 ... 1 mm ² / 22 ... 18 AWG
Fine-stranded conductor	0.25 ... 1.5 mm ² / 22 ... 16 AWG
Fine-stranded conductor; with insulated ferrule	0.25 ... 0.75 mm ² / 22 ... 20 AWG
Fine-stranded conductor; with uninsulated ferrule	0.25 ... 0.75 mm ² / 22 ... 20 AWG

Subject to changes. Please also observe the further product documentation!



Fine-stranded conductor; with ferrule; push-in termination	0.75 mm ² / 20 AWG
Strip length	9 mm / 0.35 inches
Pole number	5
Conductor entry direction to mating direction	0°

Physical data

Pin spacing	4.4 mm / 0.173 inches
Width	35.5 mm / 1.398 inches
Height	17.5 mm / 0.689 inches
Depth	39.85 mm / 1.569 inches

Mechanical Data

Application	DALI, Lighting Management
Coding	I
Variable coding	No
Marking	+ - L $\frac{1}{3}$ N
Potential marking	+ - L $\frac{1}{3}$ N
Mating force of a plug-in connection	approx. 20 ... 70 N (depending on pole number)
Retention force of a plug-in connection	Locked: > 80 N
Unmating force of a plug-in connection	Unlocked: approx. 20 ... 70 N (depending on pole number)
Number of mating cycles	200, without resistive load
Housing sheet thickness	0.5 ... 2 mm / 0.02 ... 0.079 inches
Mounting type	Snap-in flange
Protection type	IP20; IP40 when mated

Plug-in connection

Contact type (pluggable connector)	Male connector/plug
Connector (connection type)	for conductor
Mismating protection	Yes
Note on mismating protection	All <i>WINSTA</i> [®] components are 100% protected against mismating when: a.) plugging different numbers of poles b.) plugging while rotated 180 c.) plugging while laterally staggered d.) plugging one pole
Locking lever	yes
Locking of plug-in connection	locking lever

Subject to changes. Please also observe the further product documentation!



Note on locking system

All connectors for mounted installations (snap-in versions for lighting fixtures or devices, all types of PCB and distribution connectors) are factory-equipped with locking levers to ensure plugs and sockets are securely locked. Additional locking levers are only required for flying leads (plug/socket).

Material data

Note (material data)

Information on material specifications can be found here

Color	blue
Cover color	gray
Material group	I
Insulation material	Polyamide (PA66)
Flammability class per UL94	V0
Clamping spring material	Chrome-nickel spring steel (CrNi)
Contact material	Copper or copper alloy; surface-treated
Contact plating	Tin
Fire load	0.252 MJ
Weight	8 g

Environmental requirements

Processing temperature	-5 ... +40 °C
Continuous operating temperature	-35 ... +85 °C
Note on continuous operating temperature	Insulating parts for temperatures \leq 105 °C

Commercial data

Product Group	20 (Winsta)
eCl@ss 10.0	27-44-06-02
eCl@ss 9.0	27-44-06-02
ETIM 8.0	EC002566
ETIM 7.0	EC002566
ECCN	NO DATA
PU (SPU)	50 (50) pcs
Packaging type	box
Country of origin	PL
GTIN	4045454885311
Customs tariff number	85366990990

Subject to changes. Please also observe the further product documentation!

WAGO GmbH & Co. KG
 Hansastr. 27
 32423 Minden
 Phone: +49571 887-0 | Fax: +49571 887-169
 Email: info.de@wago.com | Web: www.wago.com

Do you have any questions about our products?
 We are always happy to take your call at +49 (571) 887-44222.



Environmental Product Compliance

RoHS Compliance Status



Compliant, No Exemption

Approvals / Certificates



General approvals

Logo	Approval	Additional Approval Text	Certificate name
	CCA DEKRA Certification B.V.	EN 61535	71-123231
	CCA DEKRA Certification B.V.	IEC 61535	NL-85020
	cURus Underwriters Laboratories Inc.	UL 1977	E45171

Declarations of conformity and manufacturer's declarations

Logo	Approval	Additional Approval Text	Certificate name
	EU-Declaration of Conformity WAGO GmbH & Co. KG	-	-
	UK-Declaration of Conformity WAGO GmbH & Co. KG	-	-

Approvals for marine applications

Logo	Approval	Additional Approval Text	Certificate name
	ABS American Bureau of Shipping	Steel Vessel Rules	19-HG1869855-PDA
	DNV GL Det Norske Veritas, Germanischer Lloyd	-	TAE00001Z6
	LR	EN 61535	08/20047

Subject to changes. Please also observe the further product documentation!

WAGO GmbH & Co. KG
 Hansastr. 27
 32423 Minden
 Phone: +49571 887-0 | Fax: +49571 887-169
 Email: info.de@wago.com | Web: www.wago.com



Do you have any questions about our products?
 We are always happy to take your call at +49 (571) 887-44222.



Lloyds Register

(E2)



Counterpart

	Item no.890-1105 Socket; 5-pole; Cod. I; 1,50 mm ² ; blue	www.wago.com/890-1105
	Item no.891-8985/006-101 pre-assembled interconnecting cable; Eca; Socket/plug; 5-pole; Cod. I; H05VV-F 5G 1.5 mm ² ; 1 m; 1,50 mm ² ; blue	www.wago.com/891-8985/006-101
	Item no.891-8985/106-101 pre-assembled connecting cable; Eca; Socket/open-ended; 5-pole; Cod. I; H05VV-F 5G 1.5 mm ² ; 1 m; 1,50 mm ² ; blue	www.wago.com/891-8985/106-101

Optional accessories



Cover

Cover

	Item no.: 770-693 Lockout cap; 3-pole; for cutouts; Plastic; white	www.wago.com/770-693
	Item no.: 770-643 Lockout cap; 3-pole; for cutouts; Plastic; black	www.wago.com/770-643

Tool

Operating tool

	Item no.: 210-719 Operating tool; Blade: 2.5 x 0.4 mm; with a partially insulated shaft	www.wago.com/210-719
	Item no.: 890-385 Operating tool; 5-way; green	www.wago.com/890-385

Downloads

Documentation

Bid Text

890-2115 X81 - Datei	2019 Feb 19	xml 3.0 kB	Download
890-2115	2015 Jun 8	doc	Download

Subject to changes. Please also observe the further product documentation!

WAGO GmbH & Co. KG
Hansastr. 27
32423 Minden
Phone: +49571 887-0 | Fax: +49571 887-169
Email: info.de@wago.com | Web: www.wago.com

Do you have any questions about our products?
We are always happy to take your call at +49 (571) 887-44222.



doc - Datei

23.6 kB

CAD/CAE-Data

CAE data

EPLAN Data Portal 890-2115	URL	Download
----------------------------	---------------------	--------------------------

WSCAD Universe 890-2115	URL	Download
-------------------------	---------------------	--------------------------

ZUKEN Portal 890-2115	URL	Download
-----------------------	---------------------	--------------------------

CAD data

2D/3D Models 890-2115	URL	Download
-----------------------	---------------------	--------------------------

Asset Administration Shell

Asset Administration Shell 890-2115	URL	Download
-------------------------------------	---------------------	--------------------------

Environmental Product Compliance

Compliance Search

Environmental Product Compliance 890-2115	URL	Download
---	---------------------	--------------------------

Snap-in plug; 5-pole; Cod. I; 1,50 mm²; blue

Installation Notes

Conductor termination

Subject to changes. Please also observe the further product documentation!

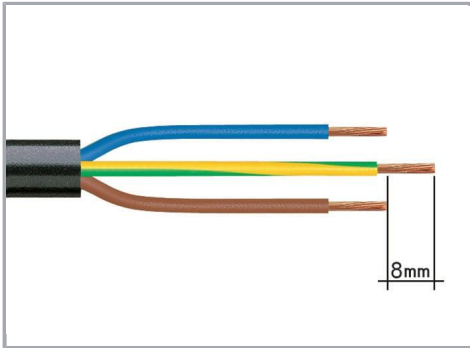

1. Strip length, outer insulation = 30 mm (2-pole), 37 mm (3-pole), 45 mm (4- and 5-pole)
2. Strip length = 9 mm
3. Extended ground conductor = 8 mm

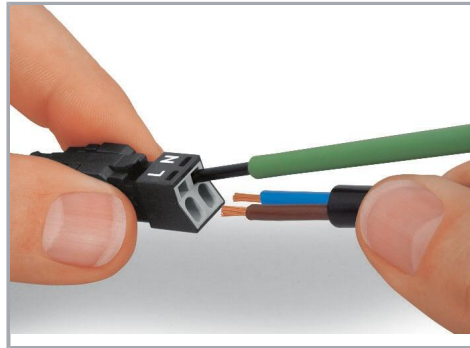

To terminate fine-stranded conductors, open the clamping unit via screwdriver – 2.5 mm blade width – and insert a stripped conductor until it hits the backstop. Terminate solid conductors by simply pushing them in.

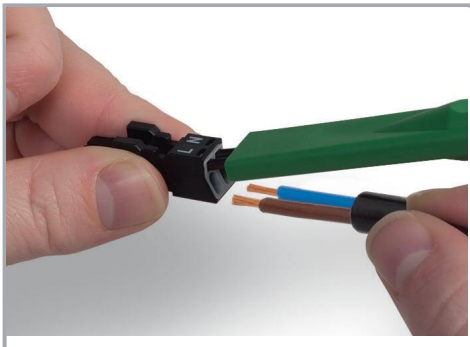

To terminate fine-stranded conductors, open clamping units via operating tool (890-382) and insert stripped conductors until they hit backstop. Terminate solid conductors by simply pushing them in.

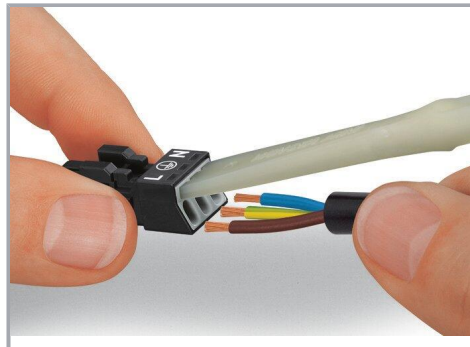

Product family

WINSTA® MINI

[Show all products from the family](#)

Subject to changes. Please also observe the further product documentation!