

Item description

Male connector/plug *WINSTA*® MINI with protection type IP20

The *WINSTA*® MINI male connector/plug with protection against mismatching supports fast, reliable installation. Whether on PCBs, in control cabinets or for connecting lights – pluggable installation connectors from WAGO allow you to establish connections according to various requirements in no time flat. For greater protection in electrical installations, the pluggable installation connector is provided with mechanical protection against mismatching. Pluggable installation connectors with B coding from the *WINSTA*® MINI line are available in gray, light green, or pink, allowing you to distinguish different circuits, for example for light, pumps or, sun blinds. Usage-specific pole marking is possible in addition. *WINSTA*® MINI is our response to the trend toward miniaturisation. Our smallest pluggable connection system is primarily suited for lights, for instance, since due to LED technology, these offer less and less space for the connection technology.

Push-in *CAGE CLAMP*® spring pressure connection technology – pluggable installation instead of laborious screw connections!

WINSTA® is the pluggable connection system that is perfectly tailored to the strict requirements of electrical installation. It ensures error-free installation of cables and components, quickly and reliably. Take advantage of the pluggable version of our maintenance-free spring pressure

Subject to changes. Please also observe the further product documentation!



connection technology too! Plan your installation with with marking from WAGO.

- protection against mismatching eliminates errors
- compact design for conductors with a cross-section up to 1.5 mm²
- with B coding for controllers such as sun blinds and lighting fixtures
- flexible installation to save space
- quick replacement of defective units during ongoing operation

Data

Notes

Variants: Other pole markings
Other versions (or variants) can be requested from WAGO Sales or configured at <https://configurator.wago.com/>.

Electrical data

Ratings per IEC/EN

Ratings per	IEC/EN 60664-1
Nominal voltage (III/3)	250 V
Rated impulse voltage (III/3)	4 kV
Rated current	16 A
Legend (ratings)	(III / 3) ≙ Overvoltage category III / Pollution degree 3

Ratings per UL 1977

Note for the US market	Some versions may also be used for current interruption in accordance with the UL certificate in select applications with currents below 5 A and voltages up to 600 V. For further information, please contact your local sales office.
Rated voltage (UL 1977)	600 V
Rated current UL 1977	14 A

General information

Note on contact resistance	approx. 1 mΩ of contact resistance approx. 0.25 mΩ contact transition plug/socket
----------------------------	--

Subject to changes. Please also observe the further product documentation!



Connection data

Connection points	2
Total number of potentials	2

Connection 1

Connection technology	Push-in CAGE CLAMP®
Actuation type	Operating tool Push-in
Nominal cross-section	1.5 mm ² / 16 AWG
Solid conductor	0.25 ... 1.5 mm ² / 22 ... 16 AWG
Solid conductor; push-in termination	0.75 ... 1.5 mm ² / 20 ... 16 AWG
Stranded conductor	0.25 ... 1 mm ² / 22 ... 18 AWG
Fine-stranded conductor	0.25 ... 1.5 mm ² / 22 ... 16 AWG
Fine-stranded conductor; with insulated ferrule	0.25 ... 0.75 mm ² / 22 ... 20 AWG
Fine-stranded conductor; with uninsulated ferrule	0.25 ... 0.75 mm ² / 22 ... 20 AWG
Fine-stranded conductor; with ferrule; push-in termination	0.75 mm ² / 20 AWG
Strip length	9 mm / 0.35 inches
Pole number	2
Conductor entry direction to mating direction	0°

Physical data

Pin spacing	4.4 mm / 0.173 inches
Width	10.4 mm / 0.409 inches
Height	11.7 mm / 0.461 inches
Depth	34.1 mm / 1.343 inches

Mechanical Data

Application	Control technology
Coding	B
Variable coding	No
Marking	N L
Potential marking	N L
Mating force of a plug-in connection	approx. 20 ... 70 N (depending on pole number)
Retention force of a plug-in connection	Locked: > 80 N
Unmating force of a plug-in connection	Unlocked: approx. 20 ... 70 N (depending on pole number)

Subject to changes. Please also observe the further product documentation!



Number of mating cycles	200, without resistive load
Protection type	IP20; IP40 when mated with strain relief housing

Plug-in connection

Contact type (pluggable connector)	Male connector/plug
Connector (connection type)	for conductor
Mismating protection	Yes
Note on mismating protection	All <i>WINSTA</i> [®] components are 100% protected against mismating when: a.) plugging different numbers of poles b.) plugging while rotated 180 c.) plugging while laterally staggered d.) plugging one pole
Locking lever	Can be retrofitted
Locking of plug-in connection	locking lever
Note on locking system	All connectors for mounted installations (snap-in versions for lighting fixtures or devices, all types of PCB and distribution connectors) are factory-equipped with locking levers to ensure plugs and sockets are securely locked. Additional locking levers are only required for flying leads (plug/socket).

Material data

Note (material data)	Information on material specifications can be found here
Color	gray
Cover color	gray
Material group	I
Insulation material	Polyamide (PA66)
Flammability class per UL94	V0
Clamping spring material	Chrome-nickel spring steel (CrNi)
Contact material	Copper or copper alloy; surface-treated
Contact plating	Tin
Fire load	0.08 MJ
Weight	2.5 g

Environmental requirements

Processing temperature	-5 ... +40 °C
Continuous operating temperature	-35 ... +85 °C

Subject to changes. Please also observe the further product documentation!

WAGO GmbH & Co. KG
Hansastr. 27
32423 Minden
Phone: +49571 887-0 | Fax: +49571 887-169
Email: info.de@wago.com | Web: www.wago.com

Do you have any questions about our products?
We are always happy to take your call at +49 (571) 887-44222.

Note on continuous operating temperature

Insulating parts for temperatures $\leq 105\text{ }^{\circ}\text{C}$

Commercial data

eCl@ss 10.0	27-44-06-05
eCl@ss 9.0	27-44-06-05
ETIM 8.0	EC002560
ETIM 7.0	EC002560
ECCN	NO DATA
PU (SPU)	50 pcs
Packaging type	box
Country of origin	PL
GTIN	4055143499644
Customs tariff number	85366990990

Environmental Product Compliance

RoHS Compliance Status



Compliant, No Exemption

Approvals / Certificates

General approvals

Logo	Approval	Additional Approval Text	Certificate name
	CB DEKRA Certification B.V.	IEC 61984	NL-64351
	CB DEKRA Certification B.V.	EN 61984	71- 112993

Declarations of conformity and manufacturer's declarations

Logo	Approval	Additional Approval Text	Certificate name
	EU-Declaration of Conformity WAGO GmbH & Co. KG	-	-
	UK-Declaration of Conformity WAGO GmbH & Co. KG	-	-

Subject to changes. Please also observe the further product documentation!

WAGO GmbH & Co. KG

Hansastr. 27

32423 Minden

Phone: +49571 887-0 | Fax: +49571 887-169

Email: info.de@wago.com | Web: www.wago.com

Do you have any questions about our products?

We are always happy to take your call at +49 (571) 887-44222.

Approvals for marine applications





Logo	Approval	Additional Approval Text	Certificate name
	LR Lloyds Register	EN 61535	08/20047 (E2)

Counterpart



	Item no.890-242/060-000 Socket; 2-pole; Cod. B; 1,50 mm ² ; gray	www.wago.com/890-242/060-000
	Item no.890-742/060-000 Snap-in socket; 2-pole; Cod. B; 1,50 mm ² ; gray	www.wago.com/890-742/060-000

Required accessories

Locking levers

Locking system		
	Item no.: 890-111 Locking lever; for flying leads; for tool operation; black	www.wago.com/890-111
	Item no.: 890-101 Locking lever; for manual operation; black	www.wago.com/890-101
	Item no.: 890-121 Locking lever; for manual operation; white	www.wago.com/890-121
	Item no.: 890-131 Locking lever; for flying leads; for tool operation; white	www.wago.com/890-131

Strain relief

Strain relief housing		
	Item no.: 890-502 Strain relief housing; 2-pole; with locking clip; for 1 cable; 3.8 ... 8.2 mm; 30 mm; black	www.wago.com/890-502
	Item no.: 890-502/342-000 Strain relief housing; 2-pole; with locking clip; for 1 cable; 3.8 ... 8.2 mm; 17.5 mm; black	www.wago.com/890-502/342-000

Subject to changes. Please also observe the further product documentation!



Item no.: 890-512

Strain relief housing; 2-pole; with locking clip; for 1 cable; 3.8 ... 8.2 mm; 30 mm; white

www.wago.com/890-512



Item no.: 890-512/342-000

Strain relief housing; 2-pole; with locking clip; for 1 cable; 3.8 ... 8.2 mm; 17.5 mm; white

www.wago.com/890-512/342-000

Optional accessories

Mounting

Mounting accessories



Item no.: 890-310

Mounting carrier; 2- to 5-pole; for flying leads; black

www.wago.com/890-310



Item no.: 890-311

Mounting carrier; 2- to 5-pole; for flying leads; white

www.wago.com/890-311

Cover

Cover



Item no.: 897-2001

Protective cap; Type1; for sockets and plugs; PVC; red

www.wago.com/897-2001

Tool

Operating tool



Item no.: 210-719

Operating tool; Blade: 2.5 x 0.4 mm; with a partially insulated shaft

www.wago.com/210-719



Item no.: 890-382

Operating tool; 2-way; green

www.wago.com/890-382

Downloads

Documentation

Bid Text

890-252/060-000 X81 - Datei	2019 Feb 19	xml 3.1 kB	Download
890-252/060-000	2015 Jun 8	doc 24.1 kB	Download

Subject to changes. Please also observe the further product documentation!

doc - Datei

CAD/CAE-Data

CAD data

2D/3D Models 890-252/060-000	URL	Download
------------------------------	---------------------	--------------------------

CAE data

ZUKEN Portal 890-252/060-000	URL	Download
------------------------------	---------------------	--------------------------

Asset Administration Shell

Asset Administration Shell 890-252/060-000	URL	Download
--	---------------------	--------------------------

Environmental Product Compliance

Compliance Search

Environmental Product Compliance 890-252/060-000	URL	Download
--	---------------------	--------------------------

Plug; 2-pole; 1,50 mm²; gray

Installation Notes

Conductor termination

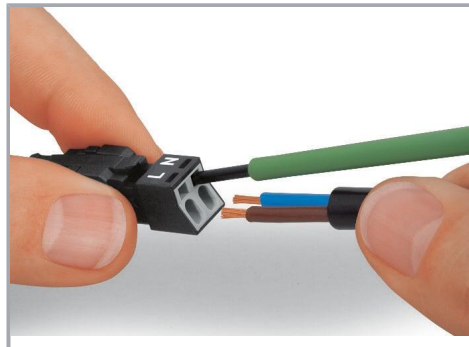
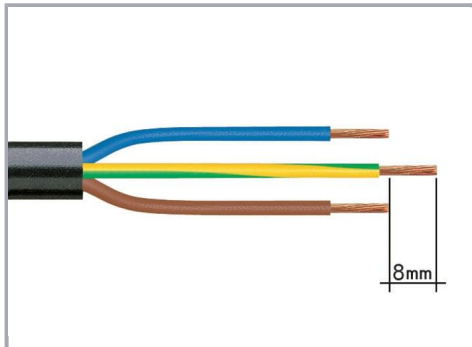

1. Strip length, outer insulation = 30 mm (2-pole), 37 mm (3-pole), 45 mm (4- and 5-pole)
2. Strip length = 9 mm
3. Extended ground conductor = 8 mm

To terminate fine-stranded conductors, open the clamping unit via screwdriver – 2.5 mm blade width – and insert a stripped conductor until it hits the backstop. Terminate solid conductors by simply pushing them in.

Subject to changes. Please also observe the further product documentation!

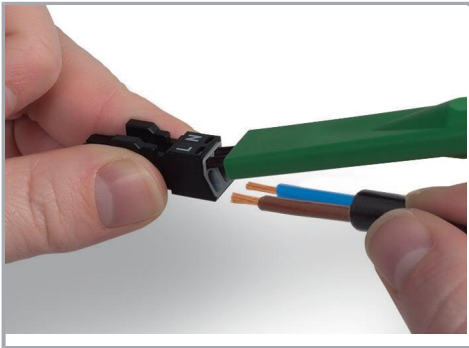

To terminate fine-stranded conductors, open clamping units via operating tool (890-382) and insert stripped conductors until they hit backstop. Terminate solid conductors by simply pushing them in.

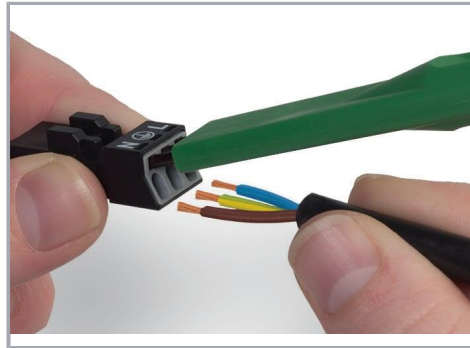

To terminate fine-stranded conductors, open clamping units via operating tool (890-383) and insert stripped conductors until they hit backstop. Terminate solid conductors by simply pushing them in.

Installation



Latch the wired connector into the base of the strain relief housing.

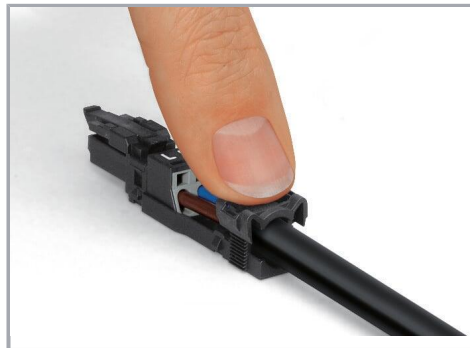

Push down strain relief clamp by hand.



Push down strain relief clamp with 2.5 mm screwdriver alternately on both sides.

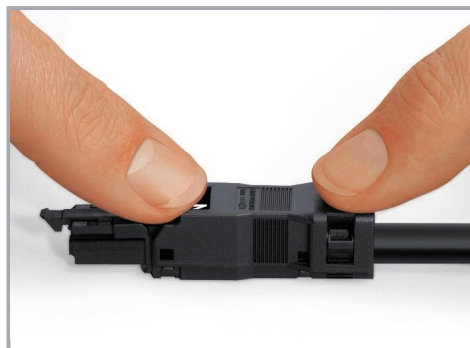

Latch the top of the strain relief housing.

Subject to changes. Please also observe the further product documentation!



The printed marking of the connector is clearly visible in the openings of the strain relief housing.

Mismatching protection

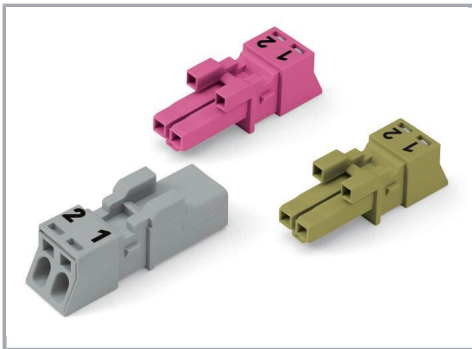

B-coded connectors with different colors can be plugged together.

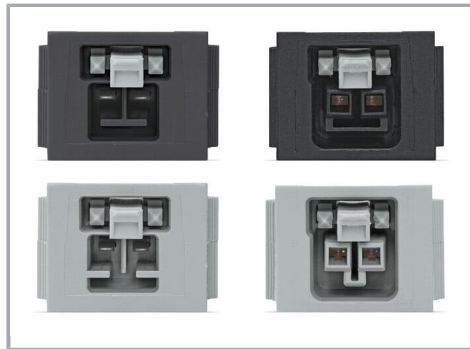

B-coded connectors (shown in gray) not only differ in color, but also in their design, making them incompatible with other coded connectors.

Important note:

Different colors and/or pole markings are used for circuit identification.

Only connectors of the same color and same pole marking must be plugged together.



Subject to changes. Please also observe the further product documentation!



Product family

WINSTA® MINI

[Show all products from the family](#)

Subject to changes. Please also observe the further product documentation!

WAGO GmbH & Co. KG

Hansastr. 27

32423 Minden

Phone: +49571 887-0 | Fax: +49571 887-169

Email: info.de@wago.com | Web: www.wago.com

Do you have any questions about our products?

We are always happy to take your call at +49 (571) 887-44222.