

Data sheet | Item number: 890-725/006-000

Snap-in socket; without locking lever; 5-pole; Cod. A; 1,50 mm²; white

www.wago.com/890-725/006-000

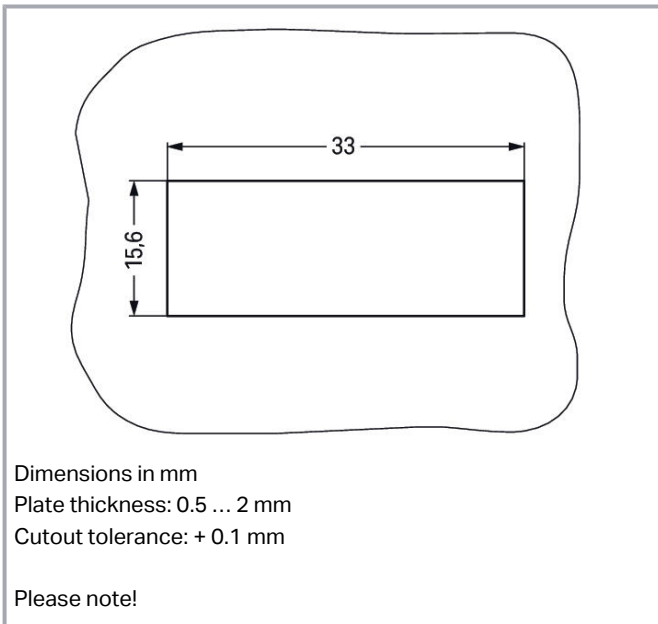
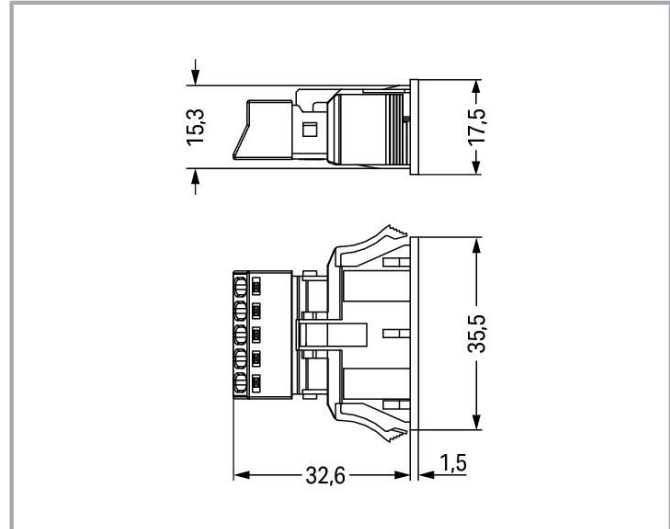
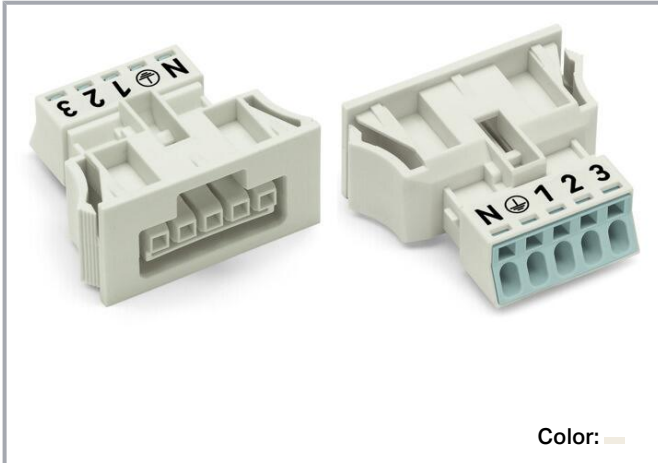

Subject to changes. Please also observe the further product documentation!

WAGO GmbH & Co. KG
Hansastr. 27
32423 Minden
Phone: +49571 887-0 | Fax: +49571 887-169
Email: info.de@wago.com | Web: www.wago.com

Do you have any questions about our products?
We are always happy to take your call at +49 (571) 887-44222.



Item description

Female connector/socket WINSTA® MINI A coding

The WINSTA® MINI female connector/socket with protection against mismatching is the pluggable solution for your use in control cabinets, on PCBs or for lighting connections. WAGO pluggable installation connectors are useful when criteria repeat or are distributed on a defined pattern, for example for installing grid lighting or flush-mount lighting. For greater security in electrical installations, the pluggable installation connector is equipped with mechanical protection against mismatching. The pluggable installation connector offers protection against contact with wires or tools if they are smaller than 1 mm in accordance with protection type IP40. The WINSTA® MINI pluggable installation connector with A coding in black or white is normally used for general mains applications in power distribution. WINSTA® MINI follows the trend towards miniaturisation. Our smallest pluggable connection system is primarily suited for lights, for example, since due to LED technology, these offer much less space for the connection technology.

Lower costs through fast commissioning and elimination of service expenses – solutions from WINSTA® MINI

The WINSTA® Pluggable Connection System is ideally tailored to the very strict requirements of building installation. It makes electrical installation pluggable, and consequently faster, more reliable, and error-free. Use of this pre-assembled system reduces time spent on assembly and installation errors at the construction site. Now you can also reduce installation costs without compromising safety and quality: with marking reduces the need for servicing and prevents unnecessary downtime.

-
- pluggable installation connectors with protection against mismatching
- consistent IP40 protection
- for any mains application
- custom-engineered solutions
- rapid, structured electrical installation

Data

Notes

Note	<p>The snap-in connectors must be relieved of tensile and transverse forces.</p> <p>A surface finish can influence the edge radius of the cutouts. This may affect the snap-in socket fit, so ensure an adequate fit before use. In addition, the punched edge should be on the inside for punched cutouts.</p> <p>The wings of the snap-in connectors must not be mechanically stressed for a long period before use (e.g., due to a pre-locking position).</p>
------	--

Subject to changes. Please also observe the further product documentation!



Electrical data

Ratings per IEC/EN

Ratings per	IEC/EN 60664-1
Nominal voltage (III/3)	400 V
Rated impulse voltage (III/3)	6 kV
Rated current	13 A
Legend (ratings)	(III / 3) $\hat{=}$ Overvoltage category III / Pollution degree 3

Ratings per UL 1977

Note for the US market	Some versions may also be used for current interruption in accordance with the UL certificate in select applications with currents below 5 A and voltages up to 600 V. For further information, please contact your local sales office.
Rated voltage (UL 1977)	600 V
Rated current UL 1977	12 A

General information

Note on contact resistance	approx. 1 m Ω of contact resistance approx. 0.25 m Ω contact transition plug/socket
----------------------------	--

Connection data

Connection points	5
Total number of potentials	5

Connection 1

Connection technology	Push-in CAGE CLAMP [®]
Actuation type	Operating tool Push-in
Nominal cross-section	1.5 mm ² / 16 AWG
Solid conductor	0.25 ... 1.5 mm ² / 22 ... 16 AWG
Solid conductor; push-in termination	0.75 ... 1.5 mm ² / 20 ... 16 AWG
Stranded conductor	0.25 ... 1 mm ² / 22 ... 18 AWG
Fine-stranded conductor	0.25 ... 1.5 mm ² / 22 ... 16 AWG
Fine-stranded conductor; with insulated ferrule	0.25 ... 0.75 mm ² / 22 ... 20 AWG
Fine-stranded conductor; with uninsulated ferrule	0.25 ... 0.75 mm ² / 22 ... 20 AWG

Subject to changes. Please also observe the further product documentation!



Fine-stranded conductor; with ferrule; push-in termination	0.75 mm ² / 20 AWG
Strip length	9 mm / 0.35 inches
Pole number	5
Conductor entry direction to mating direction	0°

Physical data

Pin spacing	4.4 mm / 0.173 inches
Width	35.5 mm / 1.398 inches
Height	17.5 mm / 0.689 inches
Depth	34.1 mm / 1.343 inches

Mechanical Data

Application	General mains applications
Coding	A
Variable coding	No
Marking	N $\frac{1}{2}$ 1 2 3
Potential marking	N $\frac{1}{2}$ 1 2 3
Mating force of a plug-in connection	approx. 20 ... 70 N (depending on pole number)
Retention force of a plug-in connection	Locked: > 80 N
Unmating force of a plug-in connection	Unlocked: approx. 20 ... 70 N (depending on pole number)
Number of mating cycles	200, without resistive load
Housing sheet thickness	0.5 ... 2 mm / 0.02 ... 0.079 inches
Mounting type	Snap-in flange
Protection type	IP40
Suitable	for lighting installation with intermediate coupler

Plug-in connection

Contact type (pluggable connector)	Female connector/socket
Connector (connection type)	for conductor
Mismating protection	Yes
Note on mismating protection	All WINSTA [®] components are 100% protected against mismating when: a.) plugging different numbers of poles b.) plugging while rotated 180 c.) plugging while laterally staggered d.) plugging one pole
Locking lever	no

Subject to changes. Please also observe the further product documentation!



Locking of plug-in connection	none
Note on locking system	All connectors for mounted installations (snap-in versions for lighting fixtures or devices, all types of PCB and distribution connectors) are factory-equipped with locking levers to ensure plugs and sockets are securely locked. Additional locking levers are only required for flying leads (plug/socket).

Material data

Note (material data)	Information on material specifications can be found here
Color	white
Cover color	gray
Material group	I
Insulation material	Polyamide (PA66)
Flammability class per UL94	V0
Clamping spring material	Chrome-nickel spring steel (CrNi)
Contact material	Copper or copper alloy; surface-treated
Contact plating	Tin
Fire load	0.247 MJ
Weight	8.6 g

Environmental requirements

Processing temperature	-5 ... +40 °C
Continuous operating temperature	-35 ... +85 °C
Note on continuous operating temperature	Insulating parts for temperatures ≤ 105 °C

Commercial data

eCl@ss 10.0	27-44-06-02
eCl@ss 9.0	27-44-06-02
ETIM 8.0	EC002566
ETIM 7.0	EC002566
ECCN	NO DATA
PU (SPU)	50 (25) pcs
Packaging type	box
Country of origin	PL
GTIN	4050821312277
Customs tariff number	85366990990

Subject to changes. Please also observe the further product documentation!

WAGO GmbH & Co. KG
Hansastr. 27
32423 Minden
Phone: +49571 887-0 | Fax: +49571 887-169
Email: info.de@wago.com | Web: www.wago.com

Do you have any questions about our products?
We are always happy to take your call at +49 (571) 887-44222.

Environmental Product Compliance

RoHS Compliance Status



Compliant, No Exemption

Approvals / Certificates



General approvals

Logo	Approval	Additional Approval Text	Certificate name
	CCA DEKRA Certification B.V.	EN 61535	71-123231
	CCA DEKRA Certification B.V.	IEC 61535	NL-85020

Declarations of conformity and manufacturer's declarations

Logo	Approval	Additional Approval Text	Certificate name
	EU-Declaration of Conformity WAGO GmbH & Co. KG	-	-
	UK-Declaration of Conformity WAGO GmbH & Co. KG	-	-

Approvals for marine applications





Logo	Approval	Additional Approval Text	Certificate name
	ABS American Bureau of Shipping	Steel Vessel Rules	19-HG1869855-PDA
	DNV GL Det Norske Veritas, Germanischer Lloyd	-	TAE00001Z6
	LR Lloyds Register	EN 61535	08/20047 (E2)

Subject to changes. Please also observe the further product documentation!

WAGO GmbH & Co. KG
Hansastr. 27
32423 Minden
Phone: +49571 887-0 | Fax: +49571 887-169
Email: info.de@wago.com | Web: www.wago.com

Do you have any questions about our products?
We are always happy to take your call at +49 (571) 887-44222.



Counterpart

	Item no. 890-135 Plug; with strain relief housing; 5-pole; 1,50 mm ² ; white	www.wago.com/890-135
	Item no. 890-235 Plug; 5-pole; Cod. A; 1,50 mm ² ; white	www.wago.com/890-235
	Item no. 891-8995/006-102 pre-assembled interconnecting cable; Eca; Socket/plug; 5-pole; Cod. A; H05VV-F 5G 1.5 mm ² ; 1 m; 1,50 mm ² ; white	www.wago.com/891-8995/006-102
	Item no. 890-655 Intermediate coupler; 5-pole; Cod. A; for sockets and plugs; white	www.wago.com/890-655
	Item no. 891-8995/206-102 pre-assembled connecting cable; Eca; Plug/open-ended; 5-pole; Cod. A; H05VV-F 5G 1.5 mm ² ; 1 m; 1,50 mm ² ; white	www.wago.com/891-8995/206-102

Optional accessories



Tool

Operating tool

	Item no.: 210-719 Operating tool; Blade: 2.5 x 0.4 mm; with a partially insulated shaft	www.wago.com/210-719
	Item no.: 890-385 Operating tool; 5-way; green	www.wago.com/890-385

Cover

Cover

	Item no.: 770-693 Lockout cap; 3-pole; for cutouts; Plastic; white	www.wago.com/770-693
	Item no.: 770-643 Lockout cap; 3-pole; for cutouts; Plastic; black	www.wago.com/770-643

Downloads

Documentation

Bid Text

890-725/006-000	2019 Feb 19	xml	Download
X81 - Datei		3.1 kB	

Subject to changes. Please also observe the further product documentation!



890-725/006-000

2015 Jun 8

doc
24.1 kB

[Download](#)

doc - Datei

CAD/CAE-Data

CAD data

2D/3D Models 890-725/006-000

[URL](#)

[Download](#)

CAE data

WSCAD Universe 890-725/006-000

[URL](#)

[Download](#)

ZUKEN Portal 890-725/006-000

[URL](#)

[Download](#)

WSCAD Universe 890-725/006-000

[URL](#)

[Download](#)

Asset Administration Shell

Asset Administration Shell 890-725/006-000

[URL](#)

[Download](#)

Environmental Product Compliance

Compliance Search

Environmental Product Compliance 890-725/006-000

[URL](#)

[Download](#)

Snap-in socket; without locking lever; 5-pole; Cod. A; 1,50 mm²; white

Installation Notes

Conductor termination

Subject to changes. Please also observe the further product documentation!

WAGO GmbH & Co. KG

Hansastr. 27

32423 Minden

Phone: +49571 887-0 | Fax: +49571 887-169

Email: info.de@wago.com | Web: www.wago.com

Do you have any questions about our products?

We are always happy to take your call at +49 (571) 887-44222.

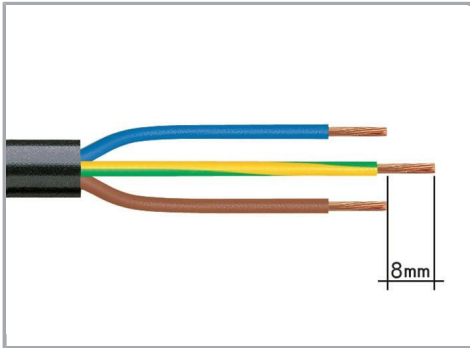

1. Strip length, outer insulation = 30 mm (2-pole), 37 mm (3-pole), 45 mm (4- and 5-pole)
2. Strip length = 9 mm
3. Extended ground conductor = 8 mm

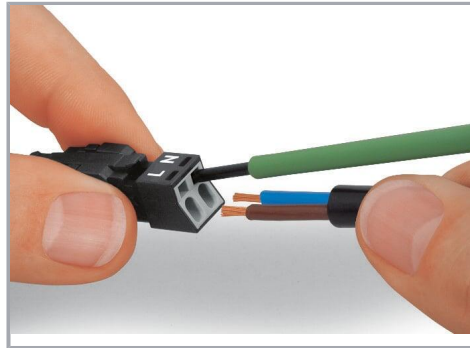

To terminate fine-stranded conductors, open the clamping unit via screwdriver – 2.5 mm blade width – and insert a stripped conductor until it hits the backstop. Terminate solid conductors by simply pushing them in.

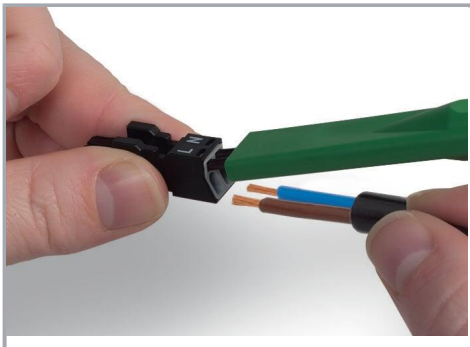

To terminate fine-stranded conductors, open clamping units via operating tool (890-382) and insert stripped conductors until they hit backstop. Terminate solid conductors by simply pushing them in.

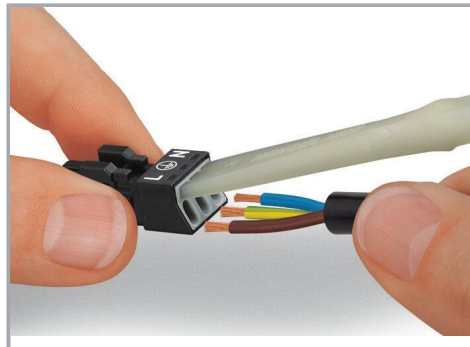

Product family

WINSTA® MINI

[Show all products from the family](#)

Subject to changes. Please also observe the further product documentation!