

Data sheet | Item number: 890-272

Plug; 2-pole; 1,50 mm²; light green

www.wago.com/890-272

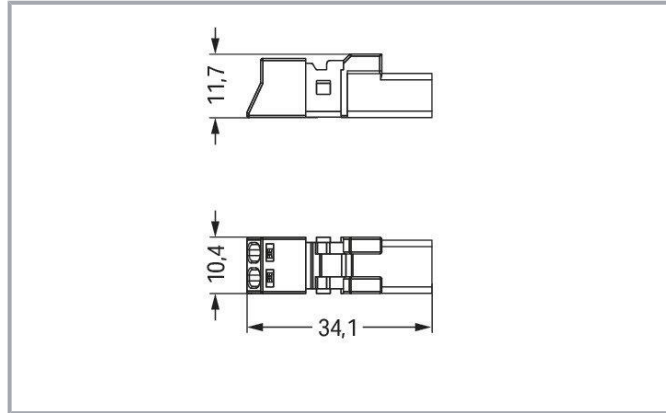
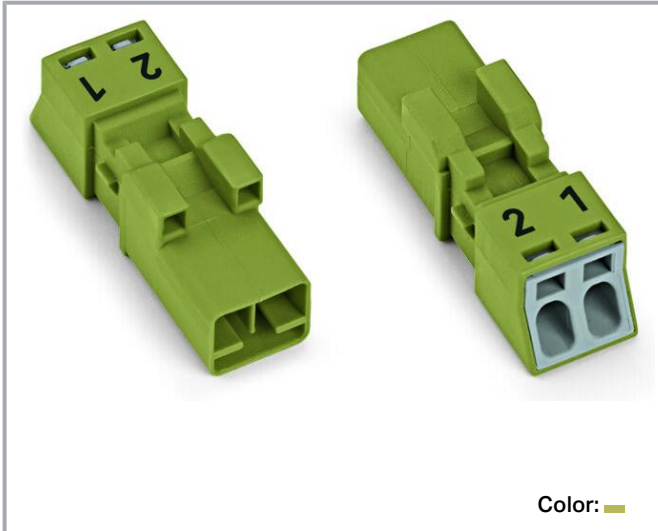

Item description

Male connector/plug *WINSTA*® MINI with protection against mismatching

The *WINSTA*® MINI male connector/plug B coding supports fast, reliable installation. Whether on PCBs, in control cabinets or for connecting lights – pluggable installation connectors from WAGO allow you to establish connections according to many different requirements in next to no time. The color coding and mechanical coding of the pluggable installation connector ensure error-free installation of the individual components – including protection against mismatching. Pluggable installation connectors with B coding from the *WINSTA*® MINI line are available in gray, light green, or pink, allowing you to distinguish different circuits, for example for light, pumps or, sun blinds. Customer-specific pole marking is possible in addition. Particularly if only limited space is available, our smallest pluggable connection system, *WINSTA*® MINI, conveniently displays its advantageous properties. It saves space, and, thanks to Push-in CAGE CLAMP® spring pressure connection technology, it additionally can be installed quickly, since the installation is low-maintenance and requires no screw connections.

Push-in CAGE CLAMP® spring pressure connection technology – pluggable installation instead of laborious screw connections!

The *WINSTA*® Pluggable Connection System allows pluggable electrical installation. This significantly reduces the need for servicing and lowers costs. Now you can also lower installation expenses without compromising quality and safety: with marking eliminates the need for servicing and

Subject to changes. Please also observe the further product documentation!

WAGO GmbH & Co. KG
Hansastr. 27
32423 Minden
Phone: +49571 887-0 | Fax: +49571 887-169
Email: info.de@wago.com | Web: www.wago.com

Do you have any questions about our products?
We are always happy to take your call at +49 (571) 887-44222.



prevents unnecessary downtime.

-
- pluggable installation connectors with protection against mismatching
- easy tool-free operation, a wide range of coding options
- with B coding for controllers such as sun blinds and lighting fixtures
- ready for immediate use
- rapid, structured electrical installation

Data

Notes

Variants:

Other pole markings

Other versions (or variants) can be requested from WAGO Sales or configured at <https://configurator.wago.com/>.

Electrical data

Ratings per IEC/EN

Ratings per	IEC/EN 60664-1
Nominal voltage (III/3)	250 V
Rated impulse voltage (III/3)	4 kV
Rated current	16 A
Legend (ratings)	(III / 3) ≙ Overvoltage category III / Pollution degree 3

Ratings per UL 1977

Note for the US market	Some versions may also be used for current interruption in accordance with the UL certificate in select applications with currents below 5 A and voltages up to 600 V. For further information, please contact your local sales office.
Rated voltage (UL 1977)	600 V
Rated current UL 1977	14 A

General information

Note on contact resistance	approx. 1 mΩ of contact resistance approx. 0.25 mΩ contact transition plug/socket
----------------------------	--

Subject to changes. Please also observe the further product documentation!



Connection data

Connection points	2
Total number of potentials	2

Connection 1

Connection technology	Push-in CAGE CLAMP®
Actuation type	Operating tool Push-in
Nominal cross-section	1.5 mm ² / 16 AWG
Solid conductor	0.25 ... 1.5 mm ² / 22 ... 16 AWG
Solid conductor; push-in termination	0.75 ... 1.5 mm ² / 20 ... 16 AWG
Stranded conductor	0.25 ... 1 mm ² / 22 ... 18 AWG
Fine-stranded conductor	0.25 ... 1.5 mm ² / 22 ... 16 AWG
Fine-stranded conductor; with insulated ferrule	0.25 ... 0.75 mm ² / 22 ... 20 AWG
Fine-stranded conductor; with uninsulated ferrule	0.25 ... 0.75 mm ² / 22 ... 20 AWG
Fine-stranded conductor; with ferrule; push-in termination	0.75 mm ² / 20 AWG
Strip length	9 mm / 0.35 inches
Pole number	2
Conductor entry direction to mating direction	0°

Physical data

Pin spacing	4.4 mm / 0.173 inches
Width	10.4 mm / 0.409 inches
Height	11.7 mm / 0.461 inches
Depth	34.1 mm / 1.343 inches

Mechanical Data

Application	Control technology
Coding	B
Variable coding	No
Marking	2 1
Potential marking	2 1
Mating force of a plug-in connection	approx. 20 ... 70 N (depending on pole number)
Retention force of a plug-in connection	Locked: > 80 N
Unmating force of a plug-in connection	Unlocked: approx. 20 ... 70 N (depending on pole number)

Subject to changes. Please also observe the further product documentation!



Number of mating cycles	200, without resistive load
Protection type	IP20; IP40 when mated with strain relief housing

Plug-in connection

Contact type (pluggable connector)	Male connector/plug
Connector (connection type)	for conductor
Mismating protection	Yes
Note on mismating protection	All <i>WINSTA</i> [®] components are 100% protected against mismating when: a.) plugging different numbers of poles b.) plugging while rotated 180 c.) plugging while laterally staggered d.) plugging one pole
Locking lever	Can be retrofitted
Locking of plug-in connection	locking lever
Note on locking system	All connectors for mounted installations (snap-in versions for lighting fixtures or devices, all types of PCB and distribution connectors) are factory-equipped with locking levers to ensure plugs and sockets are securely locked. Additional locking levers are only required for flying leads (plug/socket).

Material data

Note (material data)	Information on material specifications can be found here
Color	light green
Cover color	gray
Material group	I
Insulation material	Polyamide (PA66)
Flammability class per UL94	V0
Clamping spring material	Chrome-nickel spring steel (CrNi)
Contact material	Copper or copper alloy; surface-treated
Contact plating	Tin
Fire load	0.062 MJ
Weight	2.5 g

Environmental requirements

Processing temperature	-5 ... +40 °C
Continuous operating temperature	-35 ... +85 °C

Subject to changes. Please also observe the further product documentation!

Note on continuous operating temperature

Insulating parts for temperatures $\leq 105\text{ }^{\circ}\text{C}$

Commercial data



Product Group	20 (Winsta)
eCl@ss 10.0	27-44-06-05
eCl@ss 9.0	27-44-06-05
ETIM 8.0	EC002560
ETIM 7.0	EC002560
ECCN	NO DATA
PU (SPU)	50 pcs
Packaging type	box
Country of origin	PL
GTIN	4055143499637
Customs tariff number	85366990990

Environmental Product Compliance

RoHS Compliance Status	Compliant, No Exemption
------------------------	-------------------------

Approvals / Certificates

General approvals

Logo	Approval	Additional Approval Text	Certificate name
	CB DEKRA Certification B.V.	IEC 61984	NL-64351
	CB DEKRA Certification B.V.	EN 61984	71-112993
	cURus Underwriters Laboratories Inc.	UL 1977	E45171
	KEMA/KEUR DEKRA Certification B.V.	EN 60320	2148952.04

Declarations of conformity and manufacturer's declarations

Logo	Approval	Additional Approval Text	Certificate name
------	----------	--------------------------	------------------

Subject to changes. Please also observe the further product documentation!

WAGO GmbH & Co. KG
 Hansastr. 27
 32423 Minden
 Phone: +49571 887-0 | Fax: +49571 887-169
 Email: info.de@wago.com | Web: www.wago.com

Do you have any questions about our products?
 We are always happy to take your call at +49 (571) 887-44222.



EU-Declaration of Conformity
WAGO GmbH & Co. KG

-

-





UK-Declaration of Conformity
WAGO GmbH & Co. KG

-

-

Approvals for marine applications

Logo	Approval	Additional Approval Text	Certificate name
	DNV GL Det Norske Veritas, Germanischer Lloyd	-	TAE00001Z6
	LR Lloyds Register	EN 61535	08/20047 (E2)

Counterpart

	Item no.890-1602 T-distribution connector; 2-pole; Cod. B; 1 input; 2 outputs; 2 locking levers; light green	www.wago.com/890-1602
	Item no.890-1702 T-distribution connector; 2-pole; Cod. B; 1 input; 2 outputs; 3 locking levers; for flying leads; light green	www.wago.com/890-1702
	Item no.890-262 Socket; 2-pole; Cod. B; 1,50 mm ² ; light green	www.wago.com/890-262
	Item no.890-762 Snap-in socket; 2-pole; Cod. B; 1,50 mm ² ; light green	www.wago.com/890-762
	Item no.890-862 Socket for PCBs; straight; 2-pole; Cod. B; light green	www.wago.com/890-862
	Item no.890-862/011-000 Socket for PCBs; angled; 2-pole; Cod. B; light green	www.wago.com/890-862/011-000
	Item no.891-8992/005-105 pre-assembled interconnecting cable; Eca; Socket/plug; 2-pole; Cod. B; Control cable 2 x 1.0 mm ² ; 1 m; 1,00 mm ² ; light green	www.wago.com/891-8992/005-105
	Item no.891-8992/105-105	

Subject to changes. Please also observe the further product documentation!

pre-assembled connecting cable; Eca; Socket/open-ended; 2-pole; Cod. B; Control cable 2 x 1.0 mm²; 1 m; 1,00 mm²; light green www.wago.com/891-8992/105-105

Required accessories

Locking levers

Locking system



Item no.: 890-111
Locking lever; for flying leads; for tool operation; black

www.wago.com/890-111



Item no.: 890-101
Locking lever; for manual operation; black

www.wago.com/890-101



Item no.: 890-121
Locking lever; for manual operation; white

www.wago.com/890-121



Item no.: 890-131
Locking lever; for flying leads; for tool operation; white

www.wago.com/890-131

Strain relief

Strain relief housing



Item no.: 890-502
Strain relief housing; 2-pole; with locking clip; for 1 cable; 3.8 ... 8.2 mm; 30 mm; black

www.wago.com/890-502



Item no.: 890-502/342-000
Strain relief housing; 2-pole; with locking clip; for 1 cable; 3.8 ... 8.2 mm; 17.5 mm; black

www.wago.com/890-502/342-000



Item no.: 890-512
Strain relief housing; 2-pole; with locking clip; for 1 cable; 3.8 ... 8.2 mm; 30 mm; white

www.wago.com/890-512



Item no.: 890-512/342-000
Strain relief housing; 2-pole; with locking clip; for 1 cable; 3.8 ... 8.2 mm; 17.5 mm; white

www.wago.com/890-512/342-000

Optional accessories

Tool

Operating tool



Item no.: 210-719
Operating tool; Blade: 2.5 x 0.4 mm; with a partially insulated shaft

www.wago.com/210-719

Subject to changes. Please also observe the further product documentation!



Item no.: 890-382
Operating tool; 2-way; green

www.wago.com/890-382

Cover

Cover



Item no.: 897-2001
Protective cap; Type1; for sockets and plugs; PVC; red

www.wago.com/897-2001

Mounting

Mounting accessories



Item no.: 890-310
Mounting carrier; 2- to 5-pole; for flying leads; black

www.wago.com/890-310



Item no.: 890-311
Mounting carrier; 2- to 5-pole; for flying leads; white

www.wago.com/890-311

Downloads

Documentation

Bid Text

890-272 X81 - Datei	2019 Feb 19	xml 3.1 kB	Download
890-272 doc - Datei	2015 Jun 8	doc 24.1 kB	Download

CAD/CAE-Data

CAD data

2D/3D Models 890-272	URL	Download
----------------------	-----	----------

CAE data

ZUKEN Portal 890-272	URL	Download
WSCAD Universe 890-272	URL	Download

Asset Administration Shell

Subject to changes. Please also observe the further product documentation!

WAGO GmbH & Co. KG
Hansastr. 27
32423 Minden
Phone: +49571 887-0 | Fax: +49571 887-169
Email: info.de@wago.com | Web: www.wago.com

Do you have any questions about our products?
We are always happy to take your call at +49 (571) 887-44222.

Environmental Product Compliance

Compliance Search

Environmental Product Compliance 890-272

[URL](#)

[Download](#)

Plug; 2-pole; 1,50 mm²; light green

Installation Notes

Conductor termination

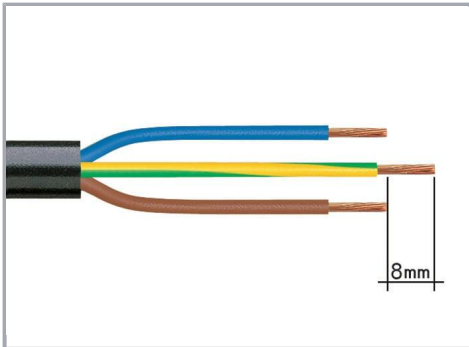

1. Strip length, outer insulation = 30 mm (2-pole), 37 mm (3-pole), 45 mm (4- and 5-pole)
2. Strip length = 9 mm
3. Extended ground conductor = 8 mm

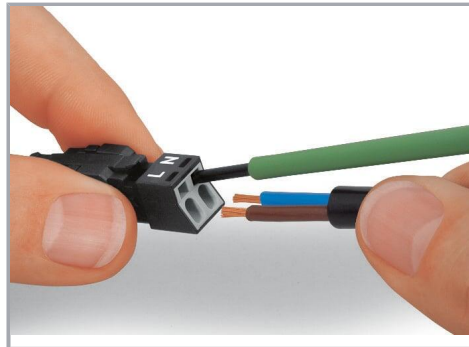

To terminate fine-stranded conductors, open the clamping unit via screwdriver – 2.5 mm blade width – and insert a stripped conductor until it hits the backstop.

Terminate solid conductors by simply pushing them in.

Subject to changes. Please also observe the further product documentation!

WAGO GmbH & Co. KG

Hansastr. 27

32423 Minden

Phone: +49571 887-0 | Fax: +49571 887-169

Email: info.de@wago.com | Web: www.wago.com

Do you have any questions about our products?

We are always happy to take your call at +49 (571) 887-44222.

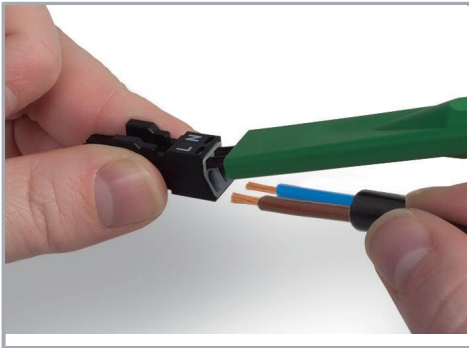

To terminate fine-stranded conductors, open clamping units via operating tool (890-382) and insert stripped conductors until they hit backstop. Terminate solid conductors by simply pushing them in.

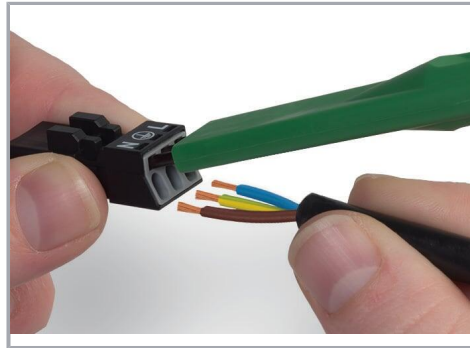

To terminate fine-stranded conductors, open clamping units via operating tool (890-383) and insert stripped conductors until they hit backstop. Terminate solid conductors by simply pushing them in.

Installation



Latch the wired connector into the base of the strain relief housing.



Push down strain relief clamp by hand.



Push down strain relief clamp with 2.5 mm screwdriver alternately on both sides.

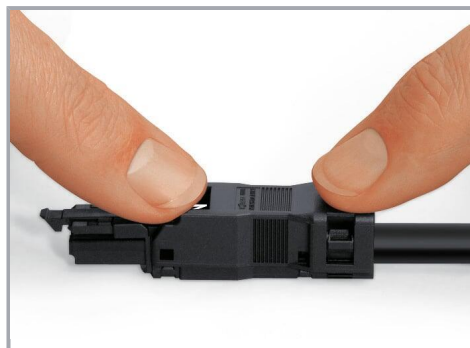

Latch the top of the strain relief housing.

Subject to changes. Please also observe the further product documentation!



The printed marking of the connector is clearly visible in the openings of the strain relief housing.

Mismatching protection

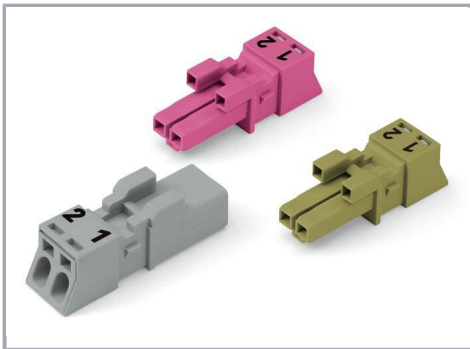

B-coded connectors with different colors can be plugged together.

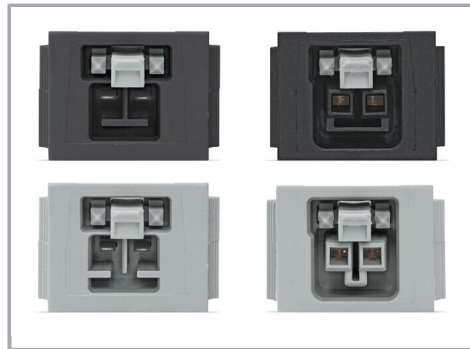

B-coded connectors (shown in gray) not only differ in color, but also in their design, making them incompatible with other coded connectors.

Important note:

Different colors and/or pole markings are used for circuit identification.

Only connectors of the same color and same pole marking must be plugged together.

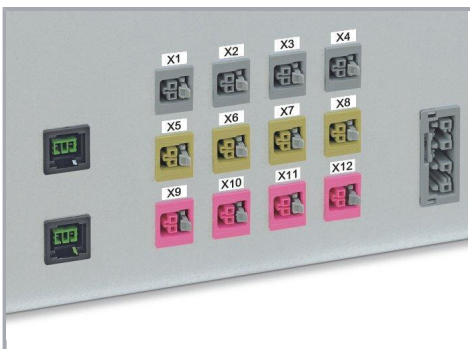

Subject to changes. Please also observe the further product documentation!

Data sheet | Item number: 890-272

www.wago.com/890-272



Product family

WINSTA® MINI

[Show all products from the family](#)

Subject to changes. Please also observe the further product documentation!

WAGO GmbH & Co. KG

Hansastr. 27

32423 Minden

Phone: +49571 887-0 | Fax: +49571 887-169

Email: info.de@wago.com | Web: www.wago.com

Do you have any questions about our products?

We are always happy to take your call at +49 (571) 887-44222.