

**Data sheet | Item number: 769-110/000-037**

1-conductor female connector; CAGE CLAMP®; 4 mm<sup>2</sup>; Pin spacing 5 mm;  
10-pole; coding finger; 4,00 mm<sup>2</sup>; gray, green-yellow

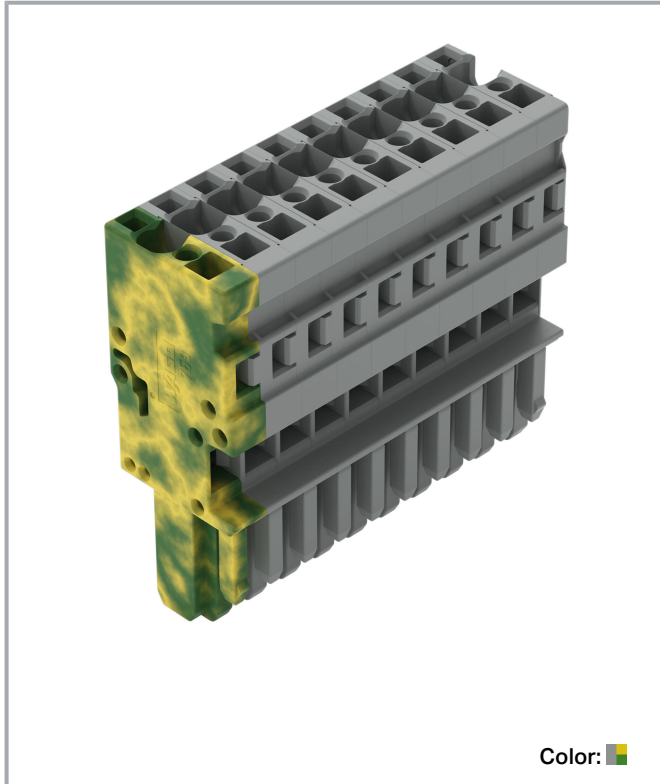

[www.wago.com/769-110/000-037](http://www.wago.com/769-110/000-037)



Color:

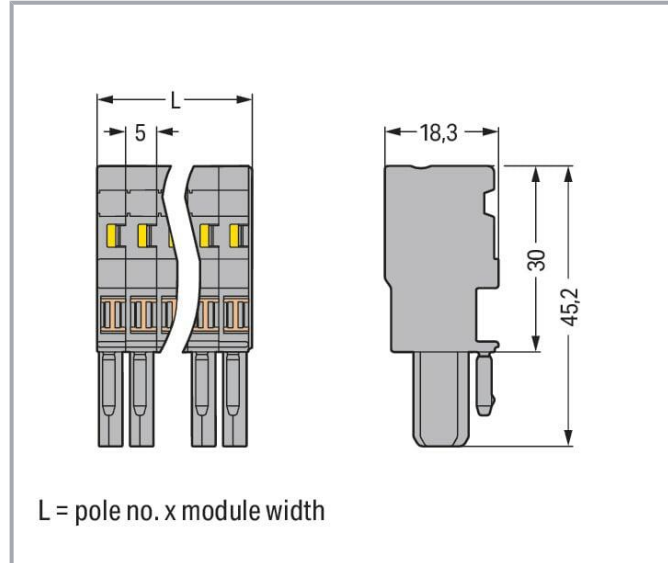

**Data**

**Notes**

Safety information

According to EN 61984, pluggable connectors without current interrupting capacity must not be mated or unmated when live or under load.

**Electrical data**

**Ratings per IEC/EN**

Ratings per	IEC/EN 61984
Nominal voltage (III/3)	500 V
Rated impulse voltage (III/3)	6 kV
Rated current	32 A

Subject to changes. Please also observe the further product documentation!

WAGO GmbH & Co. KG  
Hansastr. 27  
32423 Minden  
Phone: +49571 887-0 | Fax: +49571 887-169  
Email: [info.de@wago.com](mailto:info.de@wago.com) | Web: [www.wago.com](http://www.wago.com)

Do you have any questions about our products?  
We are always happy to take your call at +49 (571) 887-44222.

Legend (ratings)

(III / 3) ≙ Overvoltage category III / Pollution degree 3

## Connection data

Connection points	10
Total number of potentials	10

## Connection 1

Connection technology	CAGE CLAMP®
Actuation type	Operating tool
Connectable conductor materials	Copper
Nominal cross-section	4 mm <sup>2</sup> / 12 AWG
Solid conductor	0.08 ... 4 mm <sup>2</sup> / 28 ... 12 AWG
Fine-stranded conductor	0.08 ... 4 mm <sup>2</sup> / 28 ... 12 AWG
Strip length	8 ... 9 mm / 0.31 ... 0.35 inches
Pole number	10
Wiring direction	Front-entry wiring

## Physical data

Width	50 mm / 1.969 inches
Height	45.2 mm / 1.78 inches
Depth	18.3 mm / 0.72 inches
Module width	5 mm / 0.197 inches

## Mechanical Data

Variable coding	Yes
Direct ground contact to DIN-rail/drilled hole/housing	No
Marking level	Side marking
Anti-rotation protection	Yes

## Plug-in connection

Contact type (pluggable connector)	Female connector/socket
Connector (connection type)	for conductor
Mismating protection	No
Plugging without loss of pin spacing	Yes

Subject to changes. Please also observe the further product documentation!



## Material data

Note (material data)

Information on material specifications can be found here

Color	gray/green-yellow
Material group	I
Insulation material	Polyamide (PA66)
Flammability class per UL94	V0
Fire load	0.617 MJ
Halogen-free	Yes
Weight	31.5 g

## Environmental requirements

Processing temperature	-35 ... +85 °C
Continuous operating temperature	-60 ... +105 °C

## Commercial data

eCl@ss 10.0	27-14-11-06
eCl@ss 9.0	27-14-11-06
ETIM 8.0	EC001284
ETIM 7.0	EC001284
ECCN	NO DATA
PU (SPU)	25 pcs
Packaging type	box
Country of origin	DE
GTIN	4045454329310
Customs tariff number	85366990990

## Environmental Product Compliance

RoHS Compliance Status	Compliant, No Exemption
------------------------	-------------------------

## Approvals / Certificates

### General approvals

Logo	Approval	Additional Approval Text	Certificate name
	CSA	C22.2	1101144

Subject to changes. Please also observe the further product documentation!



CSA Group



UL  
Underwriters Laboratories Inc.

UL 1977

E 45171



UR  
Underwriters Laboratories Inc.

UL 1059

E45172

## Optional accessories

### Cover

Cover



Item no.: 769-436

Jumper cover; for 1-conductor female plugs; for 5 poles; gray

[www.wago.com/769-436](http://www.wago.com/769-436)

### Protective warning marker

Cover



Item no.: 280-415

Protective warning marker; for 5 terminal blocks; with high-voltage symbol, black; yellow

[www.wago.com/280-415](http://www.wago.com/280-415)

### Locking levers

Locking system



Item no.: 769-430

Locking lever; for female connectors; 1 part; Pin spacing 5 mm; 2-pole; gray

[www.wago.com/769-430](http://www.wago.com/769-430)



Item no.: 769-431

Locking lever; for female connectors; 1 part; Pin spacing 5 mm; 2-pole; orange

[www.wago.com/769-431](http://www.wago.com/769-431)

### Marking accessories

Marking strip



Item no.: 210-831

Marking strips; on reel; 2.3 mm wide; plain; Self-adhesive; white

[www.wago.com/210-831](http://www.wago.com/210-831)



Item no.: 210-834

Marking strips; on reel; 5 mm wide; plain; Self-adhesive; white

[www.wago.com/210-834](http://www.wago.com/210-834)



Item no.: 210-832

Marking strips; on reel; 3 mm wide; plain; Self-adhesive; white

[www.wago.com/210-832](http://www.wago.com/210-832)

Subject to changes. Please also observe the further product documentation!

WAGO GmbH & Co. KG

Hansastr. 27











32423 Minden

Phone: +49571 887-0 | Fax: +49571 887-169

Email: [info.de@wago.com](mailto:info.de@wago.com) | Web: [www.wago.com](http://www.wago.com)

Do you have any questions about our products?

We are always happy to take your call at +49 (571) 887-44222.

Label		
	<b>Item no.: 210-805</b> Labels; for Smart Printer; permanent adhesive; 6 x 15 mm; white	<a href="http://www.wago.com/210-805">www.wago.com/210-805</a>
	<b>Item no.: 210-805/000-002</b> Labels; for Smart Printer; permanent adhesive; 6 x 15 mm; yellow	<a href="http://www.wago.com/210-805/000-002">www.wago.com/210-805/000-002</a>
Marker		
	<b>Item no.: 2009-145</b> Mini-WSB Inline; for Smart Printer; 1700 pieces on roll; stretchable 5 - 5.2 mm; plain; snap-on type; white	<a href="http://www.wago.com/2009-145">www.wago.com/2009-145</a>
	<b>Item no.: 248-501</b> Mini-WSB marking card; as card; not stretchable; plain; snap-on type; white	<a href="http://www.wago.com/248-501">www.wago.com/248-501</a>
Jumpers		
Jumper		
	<b>Item no.: 769-402</b> Jumper; insulated; gray	<a href="http://www.wago.com/769-402">www.wago.com/769-402</a>
Ferrule		
Ferrule		
	<b>Item no.: 216-101</b> Ferrule; Sleeve for 0.5 mm <sup>2</sup> / AWG 22; uninsulated; electro-tin plated; silver-colored	<a href="http://www.wago.com/216-101">www.wago.com/216-101</a>
	<b>Item no.: 216-104</b> Ferrule; Sleeve for 1.5 mm <sup>2</sup> / AWG 16; uninsulated; electro-tin plated; silver-colored	<a href="http://www.wago.com/216-104">www.wago.com/216-104</a>
	<b>Item no.: 216-102</b> Ferrule; Sleeve for 0.75 mm <sup>2</sup> / AWG 20; uninsulated; electro-tin plated; silver-colored	<a href="http://www.wago.com/216-102">www.wago.com/216-102</a>
	<b>Item no.: 216-103</b> Ferrule; Sleeve for 1 mm <sup>2</sup> / AWG 18; uninsulated; electro-tin plated	<a href="http://www.wago.com/216-103">www.wago.com/216-103</a>
	<b>Item no.: 216-203</b> Ferrule; Sleeve for 1 mm <sup>2</sup> / AWG 18; insulated; electro-tin plated; red	<a href="http://www.wago.com/216-203">www.wago.com/216-203</a>
	<b>Item no.: 216-206</b> Ferrule; Sleeve for 2.5 mm <sup>2</sup> / AWG 14; insulated; electro-tin plated; blue	<a href="http://www.wago.com/216-206">www.wago.com/216-206</a>
	<b>Item no.: 216-202</b> Ferrule; Sleeve for 0.75 mm <sup>2</sup> / 18 AWG; insulated; electro-tin plated; gray	<a href="http://www.wago.com/216-202">www.wago.com/216-202</a>
	<b>Item no.: 216-204</b> Ferrule; Sleeve for 1.5 mm <sup>2</sup> / AWG 16; insulated; electro-tin plated; black	<a href="http://www.wago.com/216-204">www.wago.com/216-204</a>
	<b>Item no.: 216-201</b> Ferrule; Sleeve for 0.5 mm <sup>2</sup> / 20 AWG; insulated; electro-tin plated; white	<a href="http://www.wago.com/216-201">www.wago.com/216-201</a>
	<b>Item no.: 216-301</b>	

Subject to changes. Please also observe the further product documentation!

Ferrule; Sleeve for 0.25 mm<sup>2</sup> / AWG 24; insulated; electro-tin plated; yellow

[www.wago.com/216-301](http://www.wago.com/216-301)

**Item no.: 216-302**

Ferrule; Sleeve for 0.34 mm<sup>2</sup> / 22 AWG; insulated; electro-tin plated; light turquoise

[www.wago.com/216-302](http://www.wago.com/216-302)

## Tool

Operating tool



**Item no.: 210-490**

Operating tool

[www.wago.com/210-490](http://www.wago.com/210-490)



**Item no.: 769-434**

Operating tool; made of insulating material; 1-way; loose; white

[www.wago.com/769-434](http://www.wago.com/769-434)

## Strain relief

Strain relief



**Item no.: 769-1610**

Strain relief housing; for female and male connectors; 2 parts; Pin spacing 5 mm; 10-pole; gray

[www.wago.com/769-1610](http://www.wago.com/769-1610)

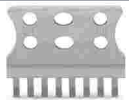

**Item no.: 769-414**

Strain relief plate; for female and male connectors; 1 part; Pin spacing 5 mm; 10- to 15-pole; gray

[www.wago.com/769-414](http://www.wago.com/769-414)

## Insulation stop

Insulation stop



**Item no.: 769-470**

Insulation stop; 0.08 - 0.2 mm<sup>2</sup> "s" (0.14 mm<sup>2</sup> "f-st"); 5 pieces/strip; white

[www.wago.com/769-470](http://www.wago.com/769-470)



**Item no.: 769-471**

Insulation stop; 0.25 - 0.5 mm<sup>2</sup>; 5 pieces/strip; light gray

[www.wago.com/769-471](http://www.wago.com/769-471)



**Item no.: 769-472**

Insulation stop; 0.75 - 1 mm<sup>2</sup>; 5 pieces/strip; dark gray

[www.wago.com/769-472](http://www.wago.com/769-472)

## Testing and measuring

Testing accessories



**Item no.: 210-136**

Test plug; 2 mm Ø; with 500 mm cable; red

[www.wago.com/210-136](http://www.wago.com/210-136)

## Downloads

### Documentation

### Bid Text

769-110/000-037

Subject to changes. Please also observe the further product documentation!

WAGO GmbH & Co. KG

Hansastr. 27

32423 Minden

Phone: +49571 887-0 | Fax: +49571 887-169

Email: [info.de@wago.com](mailto:info.de@wago.com) | Web: [www.wago.com](http://www.wago.com)

Do you have any questions about our products?

We are always happy to take your call at +49 (571) 887-44222.



X81 - Datei	2019 Feb 19	xml 3.3 kB	Download
769-110/000-037 doc - Datei	2017 Oct 4	doc 26.6 kB	Download
<b>Additional Information</b>		pdf 2.3 MB	Download

## CAD/CAE-Data

### CAE data

EPLAN Data Portal 769-110/000-037	URL	Download
WSCAD Universe 769-110/000-037	URL	Download
EPLAN Data Portal 769-110/000-037	URL	Download
WSCAD Universe 769-110/000-037	URL	Download

## Environmental Product Compliance

### Compliance Search

Environmental Product Compliance 769-110/000-037 1-conductor female connector; CAGE CLAMP®; 4 mm²; Pin spacing 5 mm; 10-pole; coding finger; 4,00 mm²; gray, green-yellow	URL	Download
---	-----	----------

## Installation Notes

### Conductor termination

Subject to changes. Please also observe the further product documentation!

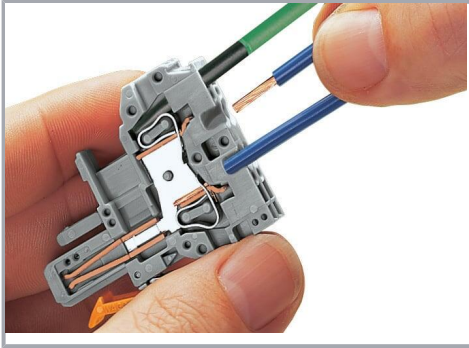

**CAGE CLAMP® connection**

Female plug: Inserting/removing a conductor via operating tool.

Operation 90° to conductor is also possible. With ferruled conductors, it is necessary to use a terminal block one size smaller than the conductor's nominal cross-section.

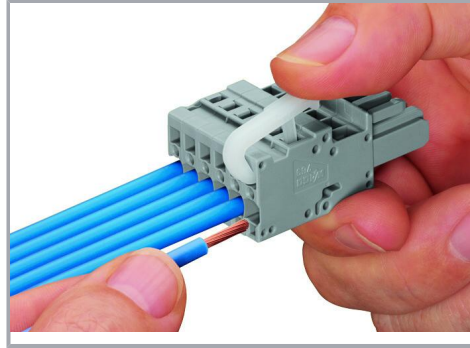

**Operating lever**

Inserting a conductor – side-entry wiring (example shows a female plug).

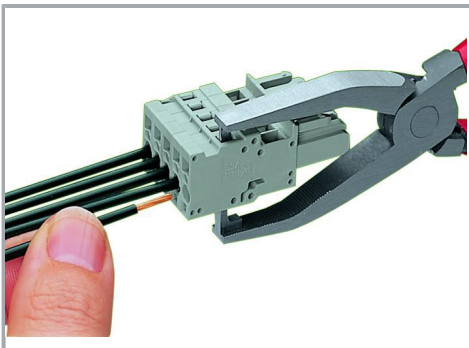

**Operating tool**

Inserting a conductor – side-entry wiring (example shows a female plug).

With ferruled conductors, it is necessary to use a terminal block one size smaller than the conductor's nominal cross-section.

**Commoning**

Subject to changes. Please also observe the further product documentation!



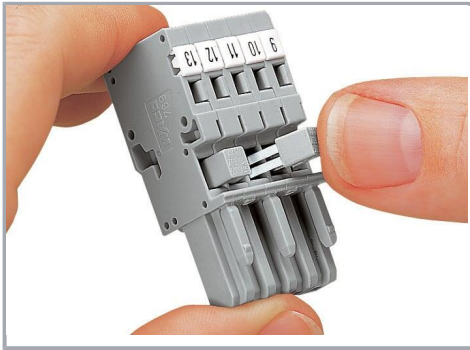

Commoning 1-conductor female plugs via miniature adjacent jumpers.

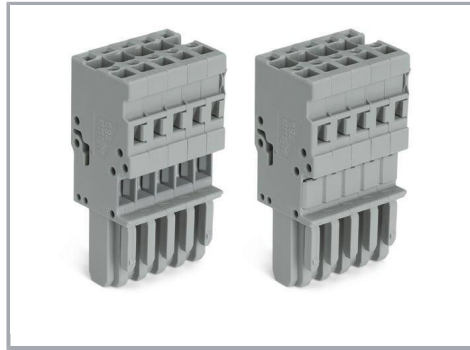

Jumper cover for 1-conductor female plugs

### Coding



Coding a female plug by removing coding finger(s) via cutting tool. Do not remove the first and last coding fingers or use an additional locking lever.

### Locking system

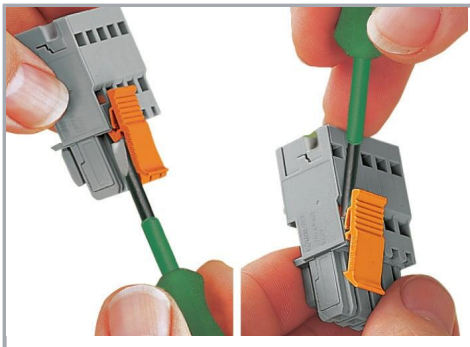

Locking/releasing a lever.

### Strain relief

Subject to changes. Please also observe the further product documentation!

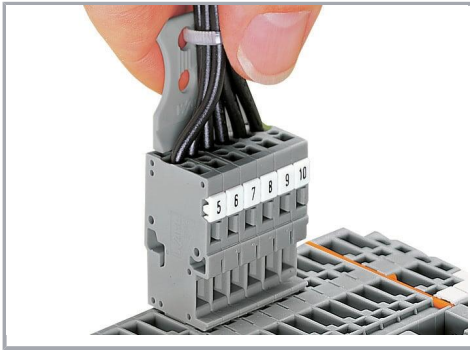

Removing a female plug via conductor bundle provided with strain relief plate.

### Marking

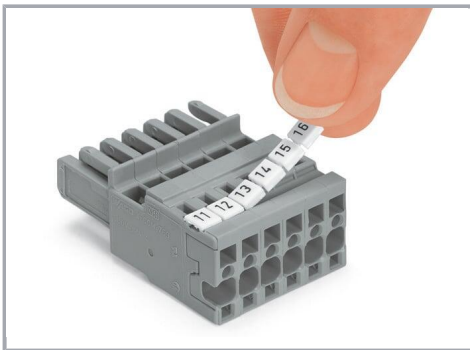

Labeling a female plug with CAGE CLAMP® connection via Mini-WSB Quick Markers.

### Product family

#### X-COM

[Show all products from the family](#)

Subject to changes. Please also observe the further product documentation!