

**Data sheet | Item number: 769-115**

1-conductor female connector; CAGE CLAMP®; 4 mm<sup>2</sup>; Pin spacing 5 mm;  
15-pole; coding finger; 4,00 mm<sup>2</sup>; gray

[www.wago.com/769-115](http://www.wago.com/769-115)

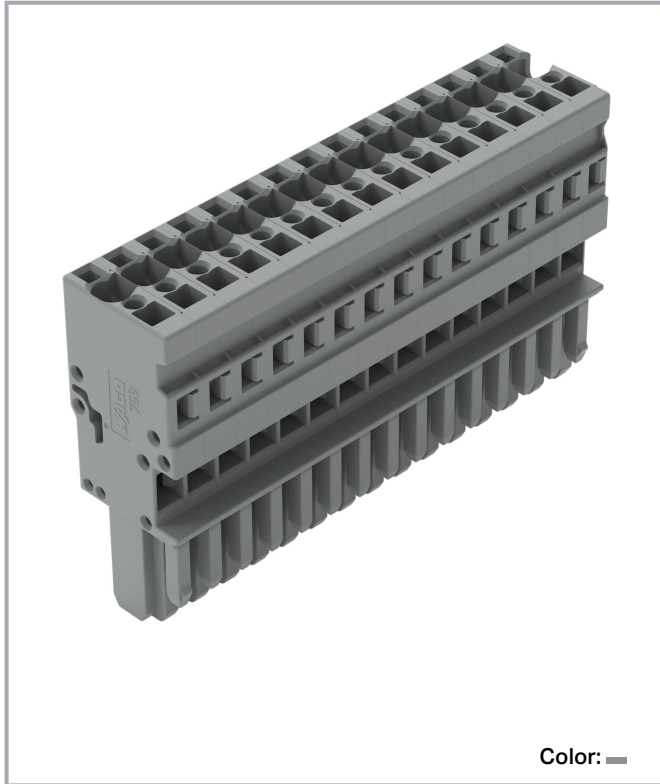

Color: ■

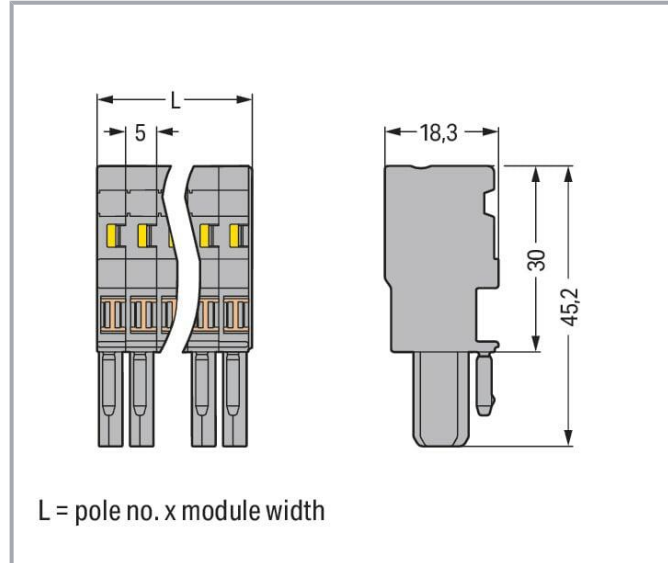

**Data**

**Notes**

Safety information

According to EN 61984, pluggable connectors without current interrupting capacity must not be mated or unmated when live or under load.

**Electrical data**

**Ratings per IEC/EN**

Ratings per	IEC/EN 61984
Nominal voltage (III/3)	500 V
Rated impulse voltage (III/3)	6 kV
Rated current	32 A

Subject to changes. Please also observe the further product documentation!

WAGO GmbH & Co. KG  
Hansastr. 27  
32423 Minden  
Phone: +49571 887-0 | Fax: +49571 887-169  
Email: [info.de@wago.com](mailto:info.de@wago.com) | Web: [www.wago.com](http://www.wago.com)

Do you have any questions about our products?  
We are always happy to take your call at +49 (571) 887-44222.



Legend (ratings)

(III / 3)  $\hat{=}$  Overvoltage category III / Pollution degree 3

## Connection data

Connection points	15
Total number of potentials	15

## Connection 1

Connection technology	CAGE CLAMP®
Actuation type	Operating tool
Connectable conductor materials	Copper
Nominal cross-section	4 mm <sup>2</sup> / 12 AWG
Solid conductor	0.08 ... 4 mm <sup>2</sup> / 28 ... 12 AWG
Fine-stranded conductor	0.08 ... 4 mm <sup>2</sup> / 28 ... 12 AWG
Strip length	8 ... 9 mm / 0.31 ... 0.35 inches
Pole number	15
Wiring direction	Front-entry wiring

## Physical data

Width	75 mm / 2.953 inches
Height	45.2 mm / 1.78 inches
Depth	18.3 mm / 0.72 inches
Module width	5 mm / 0.197 inches

## Mechanical Data

Variable coding	Yes
Direct ground contact to DIN-rail/drilled hole/housing	No
Marking level	Side marking
Anti-rotation protection	Yes

## Plug-in connection

Contact type (pluggable connector)	Female connector/socket
Connector (connection type)	for conductor
Mismating protection	No
Plugging without loss of pin spacing	Yes

Subject to changes. Please also observe the further product documentation!



## Material data

Note (material data)

Information on material specifications can be found here

Color	gray
Material group	I
Insulation material	Polyamide (PA66)
Flammability class per UL94	V0
Fire load	0.934 MJ
Halogen-free	Yes
Weight	47.2 g

## Environmental requirements

Processing temperature	-35 ... +85 °C
Continuous operating temperature	-60 ... +105 °C

## Commercial data

eCl@ss 10.0	27-14-11-06
eCl@ss 9.0	27-14-11-06
ETIM 8.0	EC001284
ETIM 7.0	EC001284
ECCN	NO DATA
PU (SPU)	10 pcs
Packaging type	box
Country of origin	DE
GTIN	4044918472319
Customs tariff number	85366990990

## Environmental Product Compliance

RoHS Compliance Status	Compliant, No Exemption
------------------------	-------------------------

## Approvals / Certificates

### General approvals

Logo	Approval	Additional Approval Text	Certificate name
	CCA	EN 60947	NTR NL-

Subject to changes. Please also observe the further product documentation!

WAGO GmbH & Co. KG  
 Hansastr. 27  
 32423 Minden  
 Phone: +49571 887-0 | Fax: +49571 887-169  
 Email: [info.de@wago.com](mailto:info.de@wago.com) | Web: [www.wago.com](http://www.wago.com)

Do you have any questions about our products?  
 We are always happy to take your call at +49 (571) 887-44222.



DEKRA Certification B.V.

7626



CCA  
DEKRA Certification B.V.

EN 61984

2190419.02



CCA  
DEKRA Certification B.V.

IEC 61984

NL-47799  
/A1

CSA  
CSA Group

C22.2

1101144



KEMA/KEUR  
DEKRA Certification B.V.

EN 60947

2190419.01



UL  
Underwriters Laboratories Inc.

UL 1977

E 45171





UR  
Underwriters Laboratories Inc.

UL 1059

E45172

## Declarations of conformity and manufacturer's declarations

Logo	Approval	Additional Approval Text	Certificate name
	EU-Declaration of Conformity WAGO GmbH & Co. KG	-	-
	UK-Declaration of Conformity WAGO GmbH & Co. KG	-	-

## Approvals for marine applications

Logo	Approval	Additional Approval Text	Certificate name
	ABS American Bureau of Shipping	EN 60947	20- HG1941090-

Subject to changes. Please also observe the further product documentation!



**BV**  
Bureau Veritas S.A.

EN 60947

07436/F0 BV

BUREAU  
VERITAS

**DNV GL**  
Det Norske Veritas, Germanischer Lloyd

-

TAE00001V2

## Counterpart



**Item no.769-615**  
1-conductor male connector; CAGE CLAMP®; 4 mm<sup>2</sup>; Pin spacing 5 mm; 15-pole; 4,00 mm<sup>2</sup>; gray

[www.wago.com/769-615](http://www.wago.com/769-615)



**Item no.769-615/004-000**  
1-conductor male connector; CAGE CLAMP®; 4 mm<sup>2</sup>; Pin spacing 5 mm; 15-pole; Feedthrough flange; 4,00 mm<sup>2</sup>; gray

[www.wago.com/769-615/004-000](http://www.wago.com/769-615/004-000)



**Item no.769-615/002-000**  
1-conductor male connector; CAGE CLAMP®; 4 mm<sup>2</sup>; Pin spacing 5 mm; 15-pole; clamping collar; 4,00 mm<sup>2</sup>; gray

[www.wago.com/769-615/002-000](http://www.wago.com/769-615/002-000)



**Item no.769-615/001-000**  
1-conductor male connector; CAGE CLAMP®; 4 mm<sup>2</sup>; Pin spacing 5 mm; 15-pole; DIN-35 rail/panel mounting; Snap-in mounting feet; 4,00 mm<sup>2</sup>; gray

[www.wago.com/769-615/001-000](http://www.wago.com/769-615/001-000)



**Item no.769-615/005-000**  
1-conductor male connector; CAGE CLAMP®; 4 mm<sup>2</sup>; Pin spacing 5 mm; 15-pole; Snap-in flange; 4,00 mm<sup>2</sup>; gray

[www.wago.com/769-615/005-000](http://www.wago.com/769-615/005-000)



**Item no.769-645/004-000**  
THT male header; 1.0 x 1.0 mm solder pin; straight; Feedthrough flange; Pin spacing 5 mm; 15-pole; gray

[www.wago.com/769-645/004-000](http://www.wago.com/769-645/004-000)



**Item no.769-645**  
THT male header; 1.0 x 1.0 mm solder pin; straight; Pin spacing 5 mm; 15-pole; gray

[www.wago.com/769-645](http://www.wago.com/769-645)

**Item no.769-615/006-000**

Subject to changes. Please also observe the further product documentation!



1-conductor male connector; CAGE CLAMP®; 4 mm²; Pin spacing 5 mm; 15-pole; Snap-in flange; 4,00 mm²; gray

[www.wago.com/769-615/006-000](http://www.wago.com/769-615/006-000)



**Item no.769-645/003-000**  
THT male header; 1.0 x 1.0 mm solder pin; straight; clamping collar; Pin spacing 5 mm; 15-pole; gray

[www.wago.com/769-645/003-000](http://www.wago.com/769-645/003-000)



**Item no.769-675/004-000**  
THT male header; 1.0 x 1.0 mm solder pin; angled; Feedthrough flange; Pin spacing 5 mm; 15-pole; gray

[www.wago.com/769-675/004-000](http://www.wago.com/769-675/004-000)



**Item no.769-675/003-000**  
THT male header; 1.0 x 1.0 mm solder pin; angled; clamping collar; Pin spacing 5 mm; 15-pole; gray

[www.wago.com/769-675/003-000](http://www.wago.com/769-675/003-000)



**Item no.769-645/007-000**  
THT male header; 1.0 x 1.0 mm solder pin; straight; clamping collar; Pin spacing 5 mm; 15-pole; gray

[www.wago.com/769-645/007-000](http://www.wago.com/769-645/007-000)



**Item no.769-675**  
THT male header; 1.0 x 1.0 mm solder pin; angled; Pin spacing 5 mm; 15-pole; gray

[www.wago.com/769-675](http://www.wago.com/769-675)

## Optional accessories

### Jumpers

Jumper



**Item no.: 769-402**  
Jumper; insulated; gray

[www.wago.com/769-402](http://www.wago.com/769-402)

### Tool

Operating tool



**Item no.: 210-490**  
Operating tool

[www.wago.com/210-490](http://www.wago.com/210-490)



**Item no.: 769-434**  
Operating tool; made of insulating material; 1-way; loose; white

[www.wago.com/769-434](http://www.wago.com/769-434)

### Protective warning marker

Cover



**Item no.: 280-415**  
Protective warning marker; for 5 terminal blocks; with high-voltage symbol, black; yellow

[www.wago.com/280-415](http://www.wago.com/280-415)

### Testing and measuring

Testing accessories

Subject to changes. Please also observe the further product documentation!













**Item no.: 210-136**

Test plug; 2 mm Ø; with 500 mm cable; red

[www.wago.com/210-136](http://www.wago.com/210-136)

## Ferrule

Ferrule

	<b>Item no.: 216-101</b> Ferrule; Sleeve for 0.5 mm <sup>2</sup> / AWG 22; uninsulated; electro-tin plated; silver-colored	<a href="http://www.wago.com/216-101">www.wago.com/216-101</a>
	<b>Item no.: 216-104</b> Ferrule; Sleeve for 1.5 mm <sup>2</sup> / AWG 16; uninsulated; electro-tin plated; silver-colored	<a href="http://www.wago.com/216-104">www.wago.com/216-104</a>
	<b>Item no.: 216-102</b> Ferrule; Sleeve for 0.75 mm <sup>2</sup> / AWG 20; uninsulated; electro-tin plated; silver-colored	<a href="http://www.wago.com/216-102">www.wago.com/216-102</a>
	<b>Item no.: 216-103</b> Ferrule; Sleeve for 1 mm <sup>2</sup> / AWG 18; uninsulated; electro-tin plated	<a href="http://www.wago.com/216-103">www.wago.com/216-103</a>
	<b>Item no.: 216-203</b> Ferrule; Sleeve for 1 mm <sup>2</sup> / AWG 18; insulated; electro-tin plated; red	<a href="http://www.wago.com/216-203">www.wago.com/216-203</a>
	<b>Item no.: 216-206</b> Ferrule; Sleeve for 2.5 mm <sup>2</sup> / AWG 14; insulated; electro-tin plated; blue	<a href="http://www.wago.com/216-206">www.wago.com/216-206</a>
	<b>Item no.: 216-202</b> Ferrule; Sleeve for 0.75 mm <sup>2</sup> / 18 AWG; insulated; electro-tin plated; gray	<a href="http://www.wago.com/216-202">www.wago.com/216-202</a>
	<b>Item no.: 216-204</b> Ferrule; Sleeve for 1.5 mm <sup>2</sup> / AWG 16; insulated; electro-tin plated; black	<a href="http://www.wago.com/216-204">www.wago.com/216-204</a>
	<b>Item no.: 216-201</b> Ferrule; Sleeve for 0.5 mm <sup>2</sup> / 20 AWG; insulated; electro-tin plated; white	<a href="http://www.wago.com/216-201">www.wago.com/216-201</a>
	<b>Item no.: 216-301</b> Ferrule; Sleeve for 0.25 mm <sup>2</sup> / AWG 24; insulated; electro-tin plated; yellow	<a href="http://www.wago.com/216-301">www.wago.com/216-301</a>
	<b>Item no.: 216-302</b> Ferrule; Sleeve for 0.34 mm <sup>2</sup> / 22 AWG; insulated; electro-tin plated; light turquoise	<a href="http://www.wago.com/216-302">www.wago.com/216-302</a>

## Locking levers

Locking system



**Item no.: 769-430**

Locking lever; for female connectors; 1 part; Pin spacing 5 mm; 2-pole; gray

[www.wago.com/769-430](http://www.wago.com/769-430)



**Item no.: 769-431**

Locking lever; for female connectors; 1 part; Pin spacing 5 mm; 2-pole; orange

[www.wago.com/769-431](http://www.wago.com/769-431)

## Insulation stop

Insulation stop

Subject to changes. Please also observe the further product documentation!

WAGO GmbH & Co. KG

Hansastr. 27

32423 Minden

Phone: +49571 887-0 | Fax: +49571 887-169

Email: [info.de@wago.com](mailto:info.de@wago.com) | Web: [www.wago.com](http://www.wago.com)

Do you have any questions about our products?

We are always happy to take your call at +49 (571) 887-44222.



**Item no.: 769-470**  
Insulation stop; 0.08 - 0.2 mm<sup>2</sup> "s" (0.14 mm<sup>2</sup> "f-st"); 5 pieces/strip; white

[www.wago.com/769-470](http://www.wago.com/769-470)



**Item no.: 769-471**  
Insulation stop; 0.25 - 0.5 mm<sup>2</sup>; 5 pieces/strip; light gray

[www.wago.com/769-471](http://www.wago.com/769-471)



**Item no.: 769-472**  
Insulation stop; 0.75 - 1 mm<sup>2</sup>; 5 pieces/strip; dark gray

[www.wago.com/769-472](http://www.wago.com/769-472)

### Strain relief

#### Strain relief



**Item no.: 769-1615**  
Strain relief housing; for female and male connectors; 2 parts; Pin spacing 5 mm; 15-pole; gray

[www.wago.com/769-1615](http://www.wago.com/769-1615)

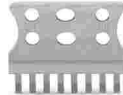

**Item no.: 769-414**  
Strain relief plate; for female and male connectors; 1 part; Pin spacing 5 mm; 10- to 15-pole; gray

[www.wago.com/769-414](http://www.wago.com/769-414)

### Marking accessories

#### Marking strip



**Item no.: 210-831**  
Marking strips; on reel; 2.3 mm wide; plain; Self-adhesive; white

[www.wago.com/210-831](http://www.wago.com/210-831)



**Item no.: 210-834**  
Marking strips; on reel; 5 mm wide; plain; Self-adhesive; white

[www.wago.com/210-834](http://www.wago.com/210-834)



**Item no.: 210-832**  
Marking strips; on reel; 3 mm wide; plain; Self-adhesive; white

[www.wago.com/210-832](http://www.wago.com/210-832)

#### Label



**Item no.: 210-805**  
Labels; for Smart Printer; permanent adhesive; 6 x 15 mm; white

[www.wago.com/210-805](http://www.wago.com/210-805)



**Item no.: 210-805/000-002**  
Labels; for Smart Printer; permanent adhesive; 6 x 15 mm; yellow

[www.wago.com/210-805/000-002](http://www.wago.com/210-805/000-002)

#### Marker



**Item no.: 2009-145**  
Mini-WSB Inline; for Smart Printer; 1700 pieces on roll; stretchable 5 - 5.2 mm; plain; snap-on type; white

[www.wago.com/2009-145](http://www.wago.com/2009-145)



**Item no.: 248-501**  
Mini-WSB marking card; as card; not stretchable; plain; snap-on type; white

[www.wago.com/248-501](http://www.wago.com/248-501)

### Cover

Subject to changes. Please also observe the further product documentation!



## Cover



Item no.: 769-436

Jumper cover; for 1-conductor female plugs; for 5 poles; gray

[www.wago.com/769-436](http://www.wago.com/769-436)

## Downloads

## Documentation

## Bid Text

769-115 X81 - Datei	2019 Feb 19	xml 3.3 kB	Download
769-115 doc - Datei	2017 Oct 4	doc 25.6 kB	Download

## Additional Information

pdf  
2.3 MB

Download

## CAD/CAE-Data

## CAD data

2D/3D Models 769-115

URL

Download

## CAE data

EPLAN Data Portal 769-115

URL

Download

WSCAD Universe 769-115

URL

Download

ZUKEN Portal 769-115

URL

Download

## Asset Administration Shell

Asset Administration Shell 769-115

URL

Download

## Environmental Product Compliance

## Compliance Search

Environmental Product Compliance 769-115

URL

Download

Subject to changes. Please also observe the further product documentation!

1-conductor female connector; CAGE CLAMP®; 4 mm<sup>2</sup>; Pin spacing 5 mm; 15-pole;  
coding finger; 4,00 mm<sup>2</sup>; gray

## Installation Notes

### Conductor termination

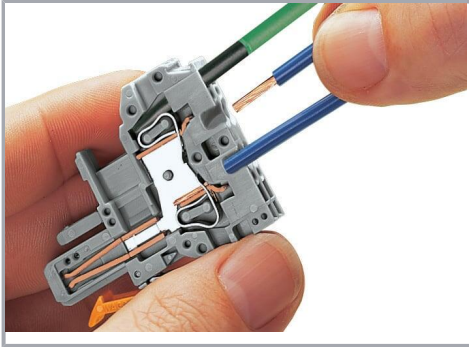

#### CAGE CLAMP® connection

Female plug: Inserting/removing a conductor via operating tool.

Operation 90° to conductor is also possible. With ferruled conductors, it is necessary to use a terminal block one size smaller than the conductor's nominal cross-section.

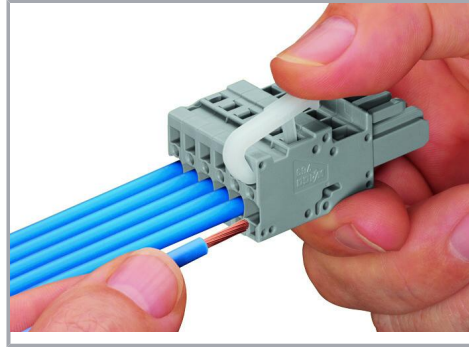

#### Operating lever

Inserting a conductor – side-entry wiring (example shows a female plug).



#### Operating tool

Inserting a conductor – side-entry wiring (example shows a female plug).

With ferruled conductors, it is necessary to use a terminal block one size smaller than the conductor's nominal cross-section.

### Commoning

Subject to changes. Please also observe the further product documentation!

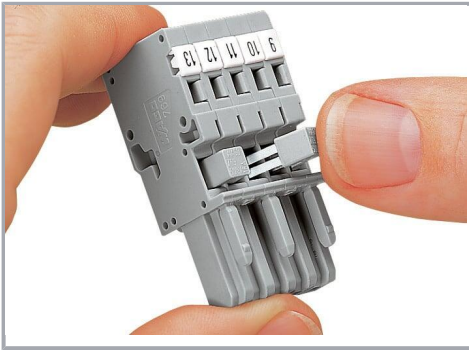

Commoning 1-conductor female plugs via miniature adjacent jumpers.

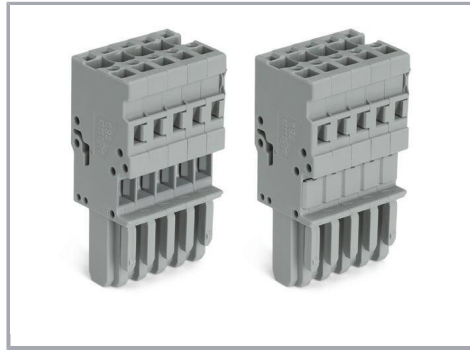

Jumper cover for 1-conductor female plugs

### Coding



Coding a female plug by removing coding finger(s) via cutting tool. Do not remove the first and last coding fingers or use an additional locking lever.

### Locking system

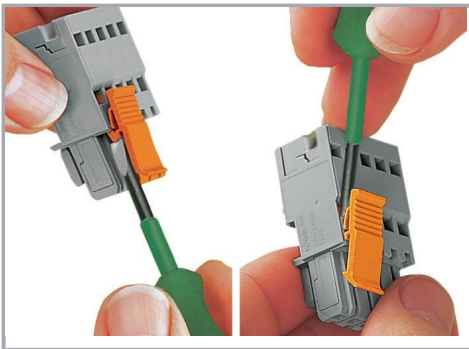

Locking/releasing a lever.

### Strain relief

Subject to changes. Please also observe the further product documentation!

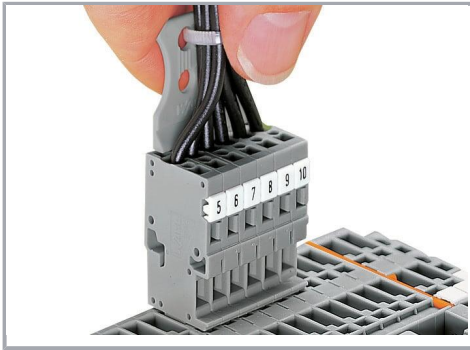

Removing a female plug via conductor bundle provided with strain relief plate.

### Marking

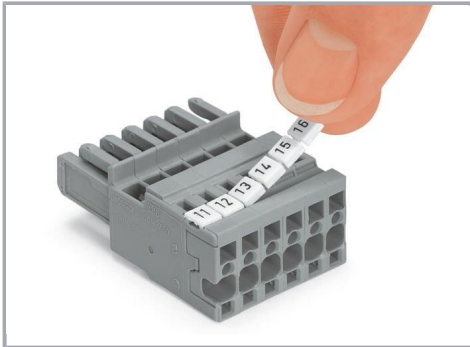

Labeling a female plug with CAGE CLAMP® connection via Mini-WSB Quick Markers.

### Product family

**X-COM**

[Show all products from the family](#)

Subject to changes. Please also observe the further product documentation!