

Data sheet | Item number: 890-743

Snap-in socket; 3-pole; Cod. B; 1,50 mm²; gray

www.wago.com/890-743

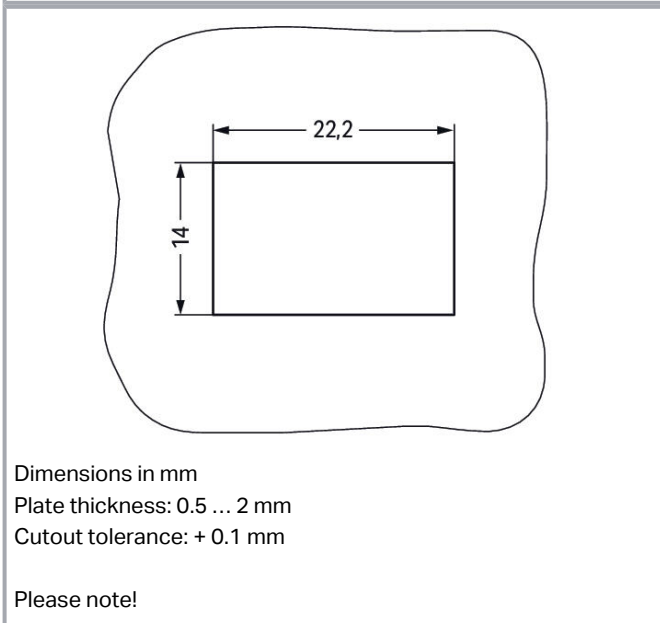
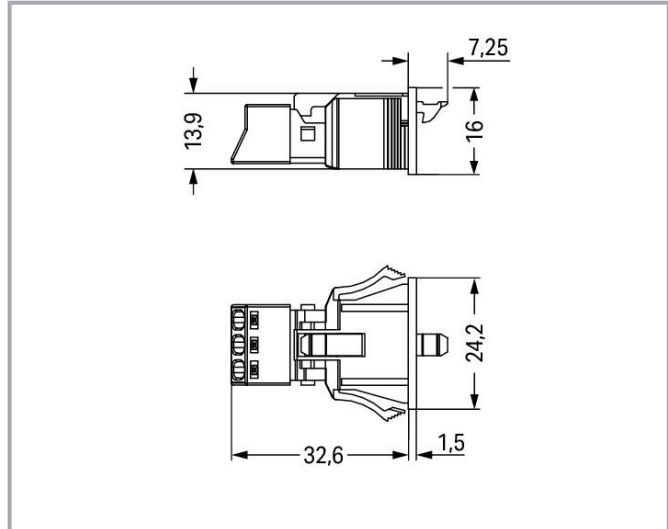
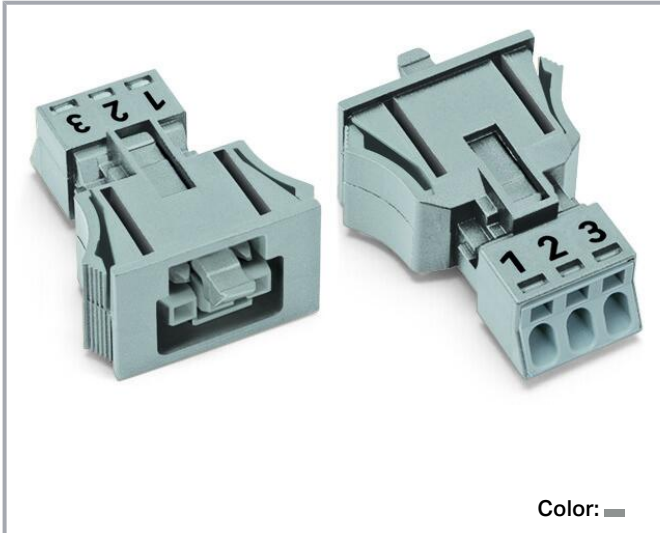

Dimensions in mm

Plate thickness: 0.5 ... 2 mm

Cutout tolerance: + 0.1 mm

Please note!

Subject to changes. Please also observe the further product documentation!

WAGO GmbH & Co. KG

Hansastr. 27

32423 Minden

Phone: +49571 887-0 | Fax: +49571 887-169

Email: info.de@wago.com | Web: www.wago.com

Do you have any questions about our products?

We are always happy to take your call at +49 (571) 887-44222.



Item description

Female connector/socket WINSTA® MINI with protection type IP40

The WINSTA® MINI female connector/socket with protection type IP40 is the pluggable solution for your application in control cabinets, for lighting connections or on PCBs. Whether on PCBs, in control cabinets or for connecting lights – pluggable installation connectors from WAGO allow you to establish connections according to a huge variety of requirements in no time flat. The mechanical coding and color coding of the pluggable installation connector ensure error-free installation of the individual components – including protection against mismatching. The pluggable installation connector is protected against ingress by solid granular objects with a diameter below 1 mm in accordance with protection type IP40. Pluggable installation connectors with B coding from the WINSTA® MINI line are available in gray, light green, or pink, allowing you to distinguish different circuits, for example for light, pumps or, sun blinds. Usage-specific pole marking is possible, too. WINSTA® MINI satisfies the demand for miniaturisation. Our smallest pluggable connection system is primarily suited for lights, for instance, since due to LED technology, these offer much less space for the connection technology.

WINSTA® MINI solutions for your electrical installation – protected against mismatching and maintenance-free

The WINSTA® Pluggable Connection System allows pluggable electrical installation. This significantly reduces the need for servicing and lowers costs. Choose quality and durability – with protection against mismatching from WAGO makes the electrical installation of electrical components substantially easier.

- pluggable installation connectors with protection against mismatching
- consistent IP40 protection
- with B coding for controllers, for example lighting fixtures and sun blinds
- custom-engineered solutions
- quick replacement of defective units during ongoing operation

Data

Notes

Note	<p>The snap-in connectors must be relieved of tensile and transverse forces.</p> <p>A surface finish can influence the edge radius of the cutouts. This may affect the snap-in socket fit, so ensure an adequate fit before use. In addition, the punched edge should be on the inside for punched cutouts.</p> <p>The wings of the snap-in connectors must not be mechanically stressed for a long period before use (e.g., due to a pre-locking position).</p>
------	--

Subject to changes. Please also observe the further product documentation!



Variants:

Other pole markings

Other versions (or variants) can be requested from WAGO Sales or configured at <https://configurator.wago.com/>.

Electrical data

Ratings per IEC/EN

Ratings per	IEC/EN 60664-1
Nominal voltage (III/3)	250 V
Rated impulse voltage (III/3)	4 kV
Rated current	16 A
Legend (ratings)	(III / 3) ≙ Overvoltage category III / Pollution degree 3

Ratings per IEC/EN – Notes

Note (rated current)	13 A for 3-pole load
----------------------	----------------------

Ratings per UL 1977

Note for the US market	Some versions may also be used for current interruption in accordance with the UL certificate in select applications with currents below 5 A and voltages up to 600 V. For further information, please contact your local sales office.
Rated voltage (UL 1977)	600 V
Rated current UL 1977	14 A

General information

Note on contact resistance	approx. 1 mΩ of contact resistance approx. 0.25 mΩ contact transition plug/socket
----------------------------	--

Connection data

Connection points	3
Total number of potentials	3

Connection 1

Connection technology	Push-in CAGE CLAMP®
Actuation type	Operating tool Push-in
Nominal cross-section	1.5 mm ² / 16 AWG

Subject to changes. Please also observe the further product documentation!



Solid conductor	0.25 ... 1.5 mm ² / 22 ... 16 AWG
Solid conductor; push-in termination	0.75 ... 1.5 mm ² / 20 ... 16 AWG
Stranded conductor	0.25 ... 1 mm ² / 22 ... 18 AWG
Fine-stranded conductor	0.25 ... 1.5 mm ² / 22 ... 16 AWG
Fine-stranded conductor; with insulated ferrule	0.25 ... 0.75 mm ² / 22 ... 20 AWG
Fine-stranded conductor; with uninsulated ferrule	0.25 ... 0.75 mm ² / 22 ... 20 AWG
Fine-stranded conductor; with ferrule; push-in termination	0.75 mm ² / 20 AWG
Strip length	9 mm / 0.35 inches
Pole number	3
Conductor entry direction to mating direction	0°

Physical data

Pin spacing	4.4 mm / 0.173 inches
Width	24.2 mm / 0.953 inches
Height	16 mm / 0.63 inches
Depth	39.85 mm / 1.569 inches

Mechanical Data

Application	Control technology
Coding	B
Variable coding	No
Marking	1 2 3
Potential marking	1 2 3
Mating force of a plug-in connection	approx. 20 ... 70 N (depending on pole number)
Retention force of a plug-in connection	Locked: > 80 N
Unmating force of a plug-in connection	Unlocked: approx. 20 ... 70 N (depending on pole number)
Number of mating cycles	200, without resistive load
Housing sheet thickness	0.5 ... 2 mm / 0.02 ... 0.079 inches
Mounting type	Snap-in flange
Protection type	IP40

Plug-in connection

Contact type (pluggable connector)	Female connector/socket
Connector (connection type)	for conductor
Mismating protection	Yes
Note on mismating protection	All WINSTA [®] components are 100% protected against mismating when:

Subject to changes. Please also observe the further product documentation!



- a.) plugging different numbers of poles
- b.) plugging while rotated 180
- c.) plugging while laterally staggered
- d.) plugging one pole

Locking lever	yes
Locking of plug-in connection	locking lever
Note on locking system	All connectors for mounted installations (snap-in versions for lighting fixtures or devices, all types of PCB and distribution connectors) are factory-equipped with locking levers to ensure plugs and sockets are securely locked. Additional locking levers are only required for flying leads (plug/socket).

Material data

Note (material data)

Information on material specifications can be found here

Color	gray
Cover color	gray
Material group	I
Insulation material	Polyamide (PA66)
Flammability class per UL94	V0
Clamping spring material	Chrome-nickel spring steel (CrNi)
Contact material	Copper or copper alloy; surface-treated
Contact plating	Tin
Fire load	0.178 MJ
Weight	6 g

Environmental requirements

Processing temperature	-5 ... +40 °C
Continuous operating temperature	-35 ... +85 °C
Note on continuous operating temperature	Insulating parts for temperatures \leq 105 °C

Commercial data

Product Group	20 (Winsta)
eCl@ss 10.0	27-44-06-02
eCl@ss 9.0	27-44-06-02
ETIM 8.0	EC002566
ETIM 7.0	EC002566
ECCN	NO DATA

Subject to changes. Please also observe the further product documentation!

WAGO GmbH & Co. KG
 Hansastr. 27
 32423 Minden
 Phone: +49571 887-0 | Fax: +49571 887-169
 Email: info.de@wago.com | Web: www.wago.com

Do you have any questions about our products?
 We are always happy to take your call at +49 (571) 887-44222.



PU (SPU)	50 (50) pcs
Packaging type	box
Country of origin	PL
GTIN	4055143427838
Customs tariff number	85366990990

Environmental Product Compliance



RoHS Compliance Status	Compliant, No Exemption
------------------------	-------------------------

Approvals / Certificates

General approvals

Logo	Approval	Additional Approval Text	Certificate name
	CB DEKRA Certification B.V.	IEC 61984	NL-64351
	CB DEKRA Certification B.V.	EN 61984	71-112993
	cURus Underwriters Laboratories Inc.	UL 1977	E45171
	KEMA/KEUR DEKRA Certification B.V.	EN 60320	2148952.04

Declarations of conformity and manufacturer's declarations

Logo	Approval	Additional Approval Text	Certificate name
	EU-Declaration of Conformity WAGO GmbH & Co. KG	-	-
	UK-Declaration of Conformity WAGO GmbH & Co. KG	-	-



Approvals for marine applications

Certificate



Subject to changes. Please also observe the further product documentation!

WAGO GmbH & Co. KG
 Hansastr. 27
 32423 Minden
 Phone: +49571 887-0 | Fax: +49571 887-169
 Email: info.de@wago.com | Web: www.wago.com

Do you have any questions about our products?
 We are always happy to take your call at +49 (571) 887-44222.

Logo	Approval	Additional Approval Text	name
	DNV GL Det Norske Veritas, Germanischer Lloyd	-	TAE00001Z6
	LR Lloyds Register	EN 61535	08/20047 (E2)



Counterpart

	Item no.891-8993/005-103 pre-assembled interconnecting cable; Eca; Socket/plug; 3-pole; Cod. B; 1 m; 1,00 mm ² ; gray	www.wago.com/891-8993/005-103
	Item no.890-253 Plug; 3-pole; Cod. B; 1,50 mm ² ; gray	www.wago.com/890-253
	Item no.891-8993/205-103 pre-assembled connecting cable; Eca; Plug/open-ended; 3-pole; Cod. B; 1 m; 1,00 mm ² ; gray	www.wago.com/891-8993/205-103

Optional accessories



Tool

Operating tool

	Item no.: 210-719 Operating tool; Blade: 2.5 x 0.4 mm; with a partially insulated shaft	www.wago.com/210-719
	Item no.: 890-383 Operating tool; 3-way; green	www.wago.com/890-383

Cover

Cover

	Item no.: 890-643 Lockout cap; 3-pole; for cutouts; Plastic; black	www.wago.com/890-643
	Item no.: 890-693 Lockout cap; 3-pole; for cutouts; Plastic; white	www.wago.com/890-693

Downloads

Documentation

Subject to changes. Please also observe the further product documentation!



Bid Text

890-743 X81 - Datei	2019 Feb 19	xml 3.0 kB	Download
890-743 doc - Datei	2018 Nov 30	doc 23.6 kB	Download

CAD/CAE-Data

CAD data

2D/3D Models 890-743	URL	Download
----------------------	-----	----------

CAE data

EPLAN Data Portal 890-743	URL	Download
ZUKEN Portal 890-743	URL	Download
WSCAD Universe 890-743	URL	Download

Asset Administration Shell

Asset Administration Shell 890-743	URL	Download
------------------------------------	-----	----------

Environmental Product Compliance

Compliance Search

Environmental Product Compliance 890-743 Snap-in socket; 3-pole; Cod. B; 1,50 mm ² ; gray	URL	Download
---	-----	----------

Installation Notes

Conductor termination

Subject to changes. Please also observe the further product documentation!

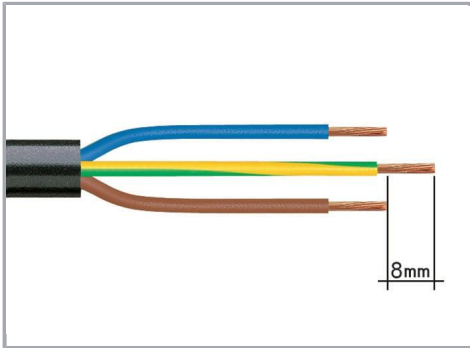

1. Strip length, outer insulation = 30 mm (2-pole), 37 mm (3-pole), 45 mm (4- and 5-pole)
2. Strip length = 9 mm
3. Extended ground conductor = 8 mm

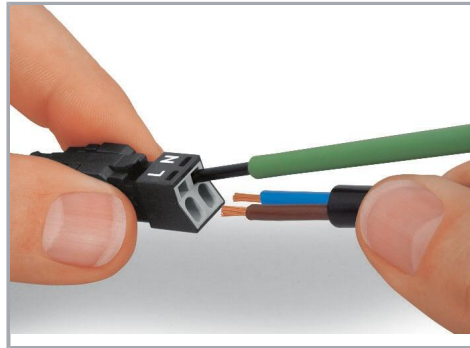

To terminate fine-stranded conductors, open the clamping unit via screwdriver – 2.5 mm blade width – and insert a stripped conductor until it hits the backstop. Terminate solid conductors by simply pushing them in.

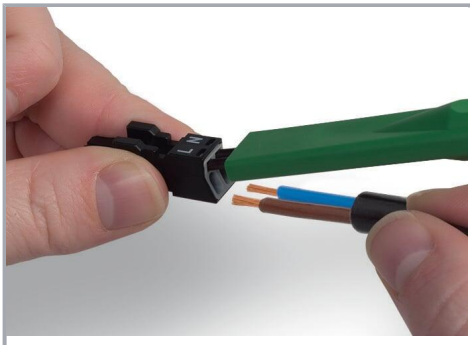

To terminate fine-stranded conductors, open clamping units via operating tool (890-382) and insert stripped conductors until they hit backstop. Terminate solid conductors by simply pushing them in.

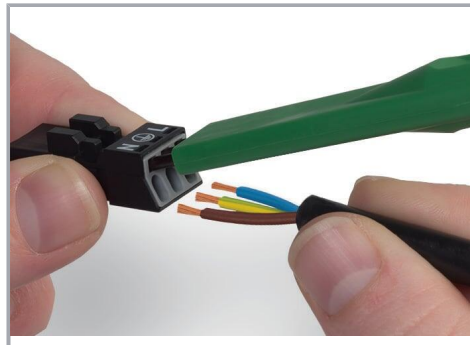

To terminate fine-stranded conductors, open clamping units via operating tool (890-383) and insert stripped conductors until they hit backstop. Terminate solid conductors by simply pushing them in.

Mismatching protection

Subject to changes. Please also observe the further product documentation!

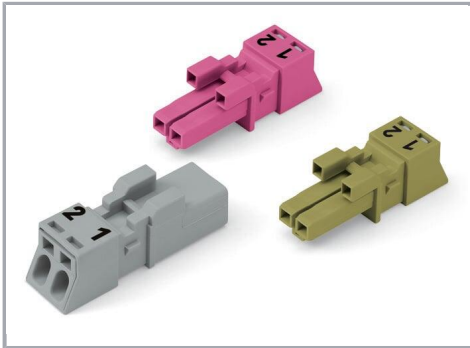

B-coded connectors with different colors can be plugged together.

Important note:

Different colors and/or pole markings are used for circuit identification.

Only connectors of the same color and same pole marking must be plugged together.

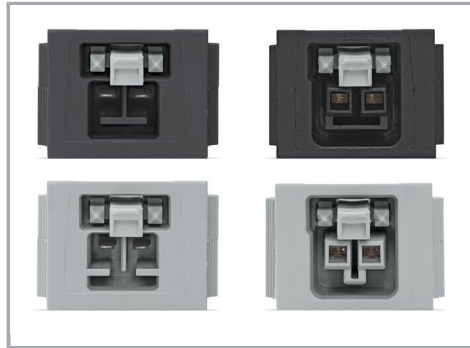

B-coded connectors (shown in gray) not only differ in color, but also in their design, making them incompatible with other coded connectors.



Product family

WINSTA® MINI

[Show all products from the family](#)

Subject to changes. Please also observe the further product documentation!