

Data sheet | Item number: 769-602/004-000

1-conductor male connector; CAGE CLAMP®; 4 mm²; Pin spacing 5 mm; 2-pole; Feedthrough flange; 4,00 mm²; gray

www.wago.com/769-602/004-000

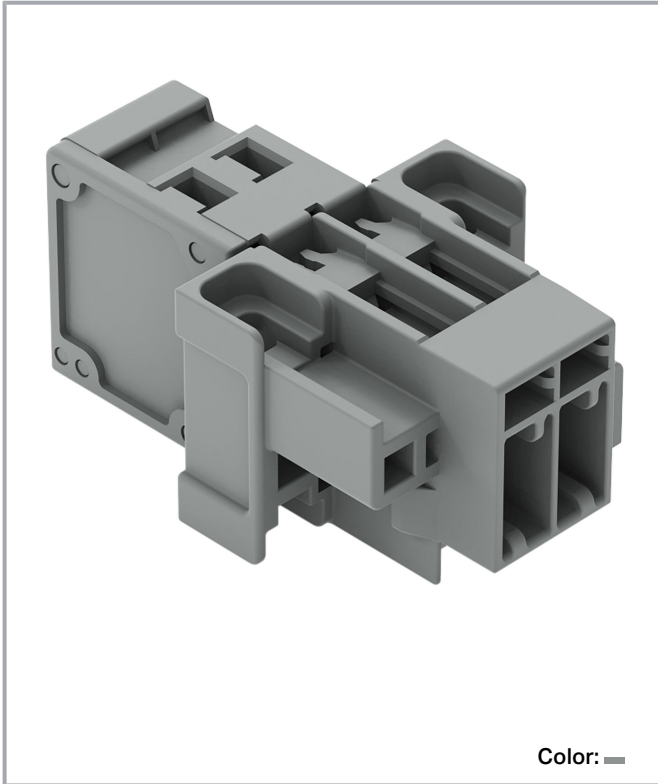

Color: ■

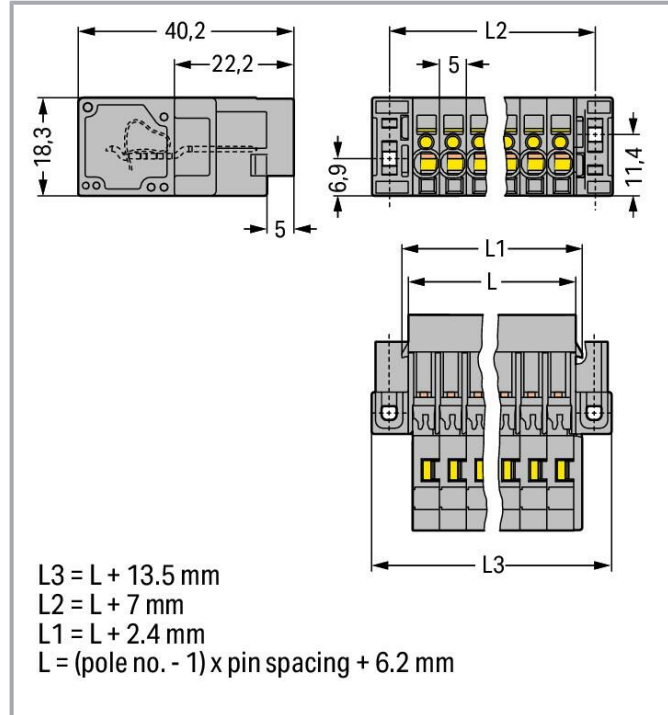

Data

Electrical data

Ratings per IEC/EN

Nominal voltage (III/3)	500 V
Rated impulse voltage (III/3)	6 kV
Rated current	32 A
Legend (ratings)	(III / 3) ≙ Overvoltage category III / Pollution degree 3

Connection data

Connection points	2
Total number of potentials	2

Subject to changes. Please also observe the further product documentation!

WAGO GmbH & Co. KG
Hansastr. 27
32423 Minden
Phone: +49571 887-0 | Fax: +49571 887-169
Email: info.de@wago.com | Web: www.wago.com

Do you have any questions about our products?
We are always happy to take your call at +49 (571) 887-44222.



Connection 1

Connection technology	CAGE CLAMP®
Actuation type	Operating tool
Connectable conductor materials	Copper
Nominal cross-section	4 mm ² / 12 AWG
Solid conductor	0.08 ... 4 mm ² / 28 ... 12 AWG
Fine-stranded conductor	0.08 ... 4 mm ² / 28 ... 12 AWG
Strip length	8 ... 9 mm / 0.31 ... 0.35 inches
Pole number	2
Wiring direction	Front-entry wiring

Physical data

Pin spacing	5 mm / 0.197 inches
Width	24.7 mm / 0.972 inches
Height from the surface	18.3 mm / 0.72 inches
Depth	40.2 mm / 1.583 inches

Mechanical Data

Variable coding	Yes
Direct ground contact to DIN-rail/drilled hole/housing	No
Mounting type	Feedthrough flange
Anti-rotation protection	Yes

Plug-in connection

Contact type (pluggable connector)	Male connector/plug
Connector (connection type)	for conductor
Mismating protection	No
Plugging without loss of pin spacing	No

Material data

Note (material data)	Information on material specifications can be found here
Color	gray
Material group	I
Insulation material	Polyamide (PA66)

Subject to changes. Please also observe the further product documentation!

Flammability class per UL94	V0
Fire load	0.286 MJ
Weight	8 g

Environmental requirements

Processing temperature	-35 ... +85 °C
Continuous operating temperature	-60 ... +105 °C

Commercial data



Product Group	18 (X-COM-System)
eCl@ss 10.0	27-14-11-06
eCl@ss 9.0	27-14-11-06
ETIM 8.0	EC001284
ETIM 7.0	EC001284
ECCN	NO DATA
PU (SPU)	100 pcs
Packaging type	Box
Country of origin	PL
GTIN	4044918520751
Customs tariff number	85366930000

Environmental Product Compliance





RoHS Compliance Status	Compliant, No Exemption
------------------------	-------------------------

Approvals / Certificates



General approvals

Logo	Approval	Additional Approval Text	Certificate name
	CCA DEKRA Certification B.V.	EN 60947	NTR NL-7626
	CCA DEKRA Certification B.V.	EN 61984	2190419.02
	CCA DEKRA Certification B.V.	IEC 61984	NL-47799 /A1

Subject to changes. Please also observe the further product documentation!

	CSA CSA Group	C22.2	1101144
	KEMA/KEUR DEKRA Certification B.V.	EN 60947	2190419.01
	UL Underwriters Laboratories Inc.	UL 1977	E 45171
	UR Underwriters Laboratories Inc.	UL 1059	E45172

Declarations of conformity and manufacturer's declarations

Logo	Approval	Additional Approval Text	Certificate name
	EU-Declaration of Conformity WAGO GmbH & Co. KG	-	-
	UK-Declaration of Conformity WAGO GmbH & Co. KG	-	-

Approvals for marine applications



Logo	Approval	Additional Approval Text	Certificate name
	DNV GL Det Norske Veritas, Germanischer Lloyd	-	TAE00001V2

Counterpart

	Item no.769-122 2-conductor female connector; CAGE CLAMP®; 4 mm ² ; Pin spacing 5 mm; 2-pole; coding finger; 4,00 mm ² ; gray	www.wago.com/769-122
---	--	--



Item no.769-102

Subject to changes. Please also observe the further product documentation!





	1-conductor female connector; CAGE CLAMP®; 4 mm ² ; Pin spacing 5 mm; 2-pole; coding finger; 4,00 mm ² ; gray	www.wago.com/769-102
	Item no. 769-102/021-000 1-conductor female connector; CAGE CLAMP®; 4 mm ² ; Pin spacing 5 mm; 2-pole; coding finger; Lateral locking levers; 4,00 mm ² ; gray	www.wago.com/769-102/021-000

Optional accessories

Insulation stop

Insulation stop		
	Item no.: 769-470 Insulation stop; 0.08 - 0.2 mm ² "s" (0.14 mm ² "f-st"); 5 pieces/strip; white	www.wago.com/769-470
	Item no.: 769-471 Insulation stop; 0.25 - 0.5 mm ² ; 5 pieces/strip; light gray	www.wago.com/769-471
	Item no.: 769-472 Insulation stop; 0.75 - 1 mm ² ; 5 pieces/strip; dark gray	www.wago.com/769-472













Marking accessories

Marking strip		
	Item no.: 210-831 Marking strips; on reel; 2.3 mm wide; plain; Self-adhesive; white	www.wago.com/210-831
	Item no.: 210-833 Marking strips; 25 m on roll; 6 mm wide; plain; Self-adhesive; white	www.wago.com/210-833
	Item no.: 210-834 Marking strips; on reel; 5 mm wide; plain; Self-adhesive; white	www.wago.com/210-834
	Item no.: 210-832 Marking strips; on reel; 3 mm wide; plain; Self-adhesive; white	www.wago.com/210-832
Marker		
	Item no.: 248-501 Mini-WSB marking card; as card; not stretchable; plain; snap-on type; white	www.wago.com/248-501

Ferrule

Ferrule		
	Item no.: 216-101 Ferrule; Sleeve for 0.5 mm ² / AWG 22; uninsulated; electro-tin plated; silver-colored	www.wago.com/216-101

Subject to changes. Please also observe the further product documentation!

	Item no.: 216-104 Ferrule; Sleeve for 1.5 mm ² / AWG 16; uninsulated; electro-tin plated; silver-colored	www.wago.com/216-104
	Item no.: 216-102 Ferrule; Sleeve for 0.75 mm ² / AWG 20; uninsulated; electro-tin plated; silver-colored	www.wago.com/216-102
	Item no.: 216-103 Ferrule; Sleeve for 1 mm ² / AWG 18; uninsulated; electro-tin plated	www.wago.com/216-103
	Item no.: 216-203 Ferrule; Sleeve for 1 mm ² / AWG 18; insulated; electro-tin plated; red	www.wago.com/216-203
	Item no.: 216-206 Ferrule; Sleeve for 2.5 mm ² / AWG 14; insulated; electro-tin plated; blue	www.wago.com/216-206
	Item no.: 216-202 Ferrule; Sleeve for 0.75 mm ² / 18 AWG; insulated; electro-tin plated; gray	www.wago.com/216-202
	Item no.: 216-204 Ferrule; Sleeve for 1.5 mm ² / AWG 16; insulated; electro-tin plated; black	www.wago.com/216-204
	Item no.: 216-201 Ferrule; Sleeve for 0.5 mm ² / 20 AWG; insulated; electro-tin plated; white	www.wago.com/216-201
Strain relief		
Strain relief		
	Item no.: 769-411 Strain relief plate; for female and male connectors; 1 part; Pin spacing 5 mm; 2- to 3-pole; gray	www.wago.com/769-411
Tool		
Operating tool		
	Item no.: 210-490 Operating tool	www.wago.com/210-490
	Item no.: 769-434 Operating tool; made of insulating material; 1-way; loose; white	www.wago.com/769-434
Protective warning marker		
Cover		
	Item no.: 280-415 Protective warning marker; for 5 terminal blocks; with high-voltage symbol, black; yellow	www.wago.com/280-415
Coding		
Coding		
	Item no.: 769-435 Coding pin; for coding of female plugs; for carrier terminal blocks / male connectors; orange	www.wago.com/769-435

Subject to changes. Please also observe the further product documentation!



Downloads

Documentation

Bid Text

769-602/004-000 X81 - Datei	2019 Feb 19	xml 3.3 kB	Download
--------------------------------	-------------	---------------	----------

769-602/004-000 doc - Datei	2017 Oct 4	doc 25.6 kB	Download
--------------------------------	------------	----------------	----------

Additional Information

		pdf 2.3 MB	Download
--	--	---------------	----------

CAD/CAE-Data

CAD data

2D/3D Models 769-602/004-000		URL	Download
------------------------------	--	-----	----------

CAE data

EPLAN Data Portal 769-602/004-000		URL	Download
-----------------------------------	--	-----	----------

WSCAD Universe 769-602/004-000		URL	Download
--------------------------------	--	-----	----------

EPLAN Data Portal 769-602/004-000		URL	Download
-----------------------------------	--	-----	----------

WSCAD Universe 769-602/004-000		URL	Download
--------------------------------	--	-----	----------

ZUKEN Portal 769-602/004-000		URL	Download
------------------------------	--	-----	----------

Asset Administration Shell

Asset Administration Shell 769-602/004-000		URL	Download
--	--	-----	----------

Environmental Product Compliance

Compliance Search

Environmental Product Compliance 769-602/004-000		URL	Download
--	--	-----	----------

Subject to changes. Please also observe the further product documentation!

1-conductor male connector; CAGE CLAMP®; 4 mm²; Pin spacing 5 mm; 2-pole;
Feedthrough flange; 4,00 mm²; gray

Installation Notes

Conductor termination



Operating tool

Inserting a conductor via operating tool
(example shows a male connector).

Marking

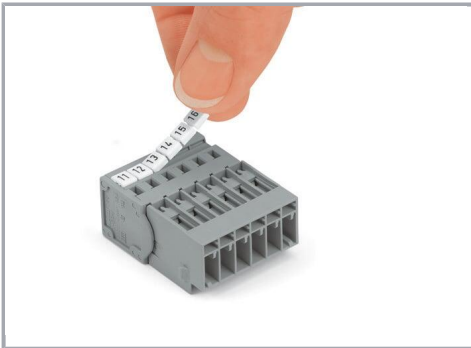

Labeling a male connector with CAGE CLAMP®
connection via Mini-WSB Quick Markers.

Product family

X-COM

[Show all products from the family](#)

Subject to changes. Please also observe the further product documentation!
