

Data sheet | Item number: 769-111/000-037

1-conductor female connector; CAGE CLAMP®; 4 mm²; Pin spacing 5 mm;
11-pole; coding finger; 4,00 mm²; gray, green-yellow

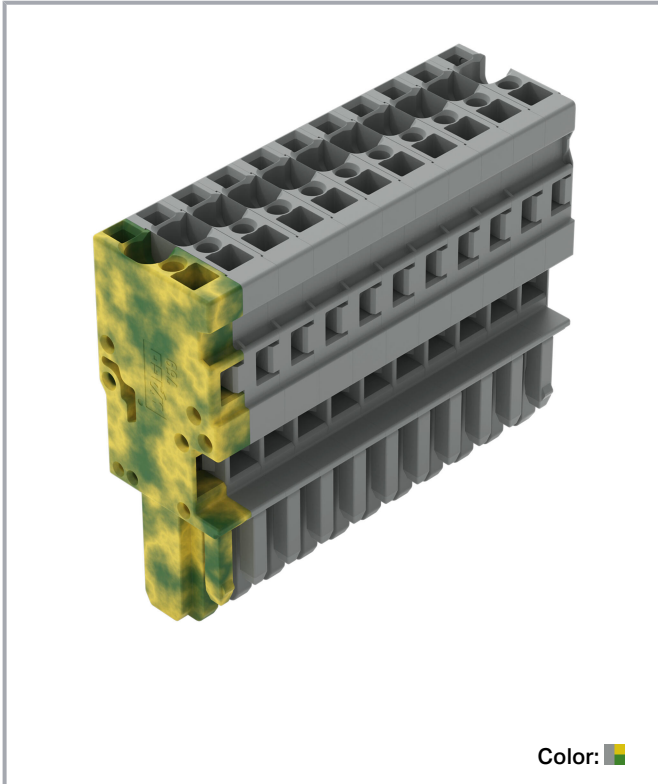

www.wago.com/769-111/000-037



Color:

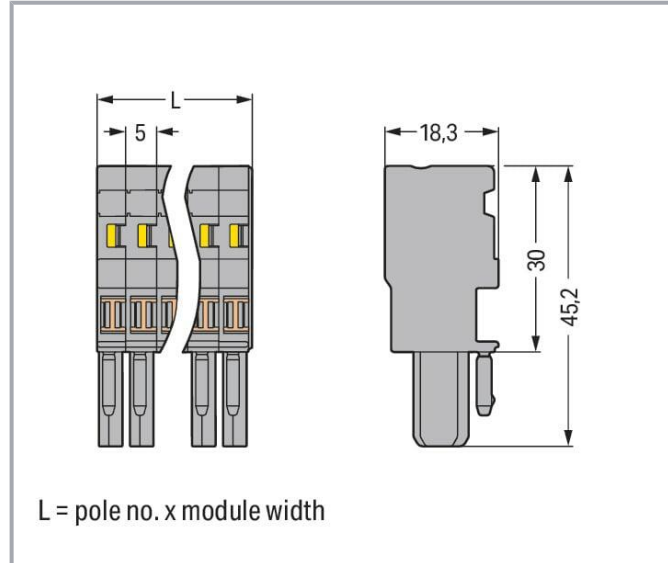

Data

Notes

Safety information

According to EN 61984, pluggable connectors without current interrupting capacity must not be mated or unmated when live or under load.

Electrical data

Ratings per IEC/EN

| Ratings per | IEC/EN 61984 |
|-------------------------------|--------------|
| Nominal voltage (III/3) | 500 V |
| Rated impulse voltage (III/3) | 6 kV |
| Rated current | 32 A |

Subject to changes. Please also observe the further product documentation!

WAGO GmbH & Co. KG
Hansastr. 27
32423 Minden
Phone: +49571 887-0 | Fax: +49571 887-169
Email: info.de@wago.com | Web: www.wago.com

Do you have any questions about our products?
We are always happy to take your call at +49 (571) 887-44222.



Legend (ratings)

(III / 3) $\hat{=}$ Overvoltage category III / Pollution degree 3

Connection data

| | |
|----------------------------|----|
| Connection points | 11 |
| Total number of potentials | 11 |

Connection 1

| | |
|---------------------------------|--|
| Connection technology | CAGE CLAMP® |
| Actuation type | Operating tool |
| Connectable conductor materials | Copper |
| Nominal cross-section | 4 mm ² / 12 AWG |
| Solid conductor | 0.08 ... 4 mm ² / 28 ... 12 AWG |
| Fine-stranded conductor | 0.08 ... 4 mm ² / 28 ... 12 AWG |
| Strip length | 8 ... 9 mm / 0.31 ... 0.35 inches |
| Pole number | 11 |
| Wiring direction | Front-entry wiring |

Physical data

| | |
|--------------|-----------------------|
| Width | 55 mm / 2.165 inches |
| Height | 45.2 mm / 1.78 inches |
| Depth | 18.3 mm / 0.72 inches |
| Module width | 5 mm / 0.197 inches |

Mechanical Data

| | |
|--|--------------|
| Variable coding | Yes |
| Direct ground contact to DIN-rail/drilled hole/housing | No |
| Marking level | Side marking |
| Anti-rotation protection | Yes |

Plug-in connection

| | |
|--------------------------------------|-------------------------|
| Contact type (pluggable connector) | Female connector/socket |
| Connector (connection type) | for conductor |
| Mismating protection | No |
| Plugging without loss of pin spacing | Yes |

Subject to changes. Please also observe the further product documentation!



Material data

Note (material data)

Information on material specifications can be found here

| | |
|-----------------------------|-------------------|
| Color | gray/green-yellow |
| Material group | I |
| Insulation material | Polyamide (PA66) |
| Flammability class per UL94 | V0 |
| Fire load | 0.678 MJ |
| Halogen-free | Yes |
| Weight | 34.6 g |

Environmental requirements

| | |
|----------------------------------|-----------------|
| Processing temperature | -35 ... +85 °C |
| Continuous operating temperature | -60 ... +105 °C |

Commercial data

| | |
|-----------------------|---------------|
| eCl@ss 10.0 | 27-14-11-06 |
| eCl@ss 9.0 | 27-14-11-06 |
| ETIM 8.0 | EC001284 |
| ETIM 7.0 | EC001284 |
| ECCN | NO DATA |
| PU (SPU) | 20 pcs |
| Packaging type | box |
| Country of origin | DE |
| GTIN | 4045454313227 |
| Customs tariff number | 85366990990 |

Environmental Product Compliance

| | |
|------------------------|-------------------------|
| RoHS Compliance Status | Compliant, No Exemption |
|------------------------|-------------------------|

Approvals / Certificates

General approvals

| Logo | Approval | Additional Approval Text | Certificate name |
|------|----------|--------------------------|------------------|
| | CSA | C22.2 | 1101144 |

Subject to changes. Please also observe the further product documentation!

WAGO GmbH & Co. KG
 Hansastr. 27
 32423 Minden
 Phone: +49571 887-0 | Fax: +49571 887-169
 Email: info.de@wago.com | Web: www.wago.com

Do you have any questions about our products?
 We are always happy to take your call at +49 (571) 887-44222.



CSA Group



UL
Underwriters Laboratories Inc.

UL 1977

E 45171













UR
Underwriters Laboratories Inc.

UL 1059

E45172

Optional accessories

Ferrule

| Ferrule | | |
|---|--|--|
|  | Item no.: 216-101 Ferrule; Sleeve for 0.5 mm ² / AWG 22; uninsulated; electro-tin plated; silver-colored | www.wago.com/216-101 |
|  | Item no.: 216-104 Ferrule; Sleeve for 1.5 mm ² / AWG 16; uninsulated; electro-tin plated; silver-colored | www.wago.com/216-104 |
|  | Item no.: 216-102 Ferrule; Sleeve for 0.75 mm ² / AWG 20; uninsulated; electro-tin plated; silver-colored | www.wago.com/216-102 |
|  | Item no.: 216-103 Ferrule; Sleeve for 1 mm ² / AWG 18; uninsulated; electro-tin plated | www.wago.com/216-103 |
|  | Item no.: 216-203 Ferrule; Sleeve for 1 mm ² / AWG 18; insulated; electro-tin plated; red | www.wago.com/216-203 |
|  | Item no.: 216-206 Ferrule; Sleeve for 2.5 mm ² / AWG 14; insulated; electro-tin plated; blue | www.wago.com/216-206 |
|  | Item no.: 216-202 Ferrule; Sleeve for 0.75 mm ² / 18 AWG; insulated; electro-tin plated; gray | www.wago.com/216-202 |
|  | Item no.: 216-204 Ferrule; Sleeve for 1.5 mm ² / AWG 16; insulated; electro-tin plated; black | www.wago.com/216-204 |
|  | Item no.: 216-201 Ferrule; Sleeve for 0.5 mm ² / 20 AWG; insulated; electro-tin plated; white | www.wago.com/216-201 |
|  | Item no.: 216-301 Ferrule; Sleeve for 0.25 mm ² / AWG 24; insulated; electro-tin plated; yellow | www.wago.com/216-301 |
|  | Item no.: 216-302 Ferrule; Sleeve for 0.34 mm ² / 22 AWG; insulated; electro-tin plated; light turquoise | www.wago.com/216-302 |

Subject to changes. Please also observe the further product documentation!

WAGO GmbH & Co. KG
Hansastr. 27
32423 Minden
Phone: +49571 887-0 | Fax: +49571 887-169
Email: info.de@wago.com | Web: www.wago.com

Do you have any questions about our products?
We are always happy to take your call at +49 (571) 887-44222.

Insulation stop

Insulation stop



Item no.: 769-470
Insulation stop; 0.08 - 0.2 mm² "s" (0.14 mm² "f-st"); 5 pieces/strip; white

www.wago.com/769-470



Item no.: 769-471
Insulation stop; 0.25 - 0.5 mm²; 5 pieces/strip; light gray

www.wago.com/769-471



Item no.: 769-472
Insulation stop; 0.75 - 1 mm²; 5 pieces/strip; dark gray

www.wago.com/769-472

Marking accessories

Marking strip



Item no.: 210-831
Marking strips; on reel; 2.3 mm wide; plain; Self-adhesive; white

www.wago.com/210-831



Item no.: 210-834
Marking strips; on reel; 5 mm wide; plain; Self-adhesive; white

www.wago.com/210-834



Item no.: 210-832
Marking strips; on reel; 3 mm wide; plain; Self-adhesive; white

www.wago.com/210-832

Label



Item no.: 210-805
Labels; for Smart Printer; permanent adhesive; 6 x 15 mm; white

www.wago.com/210-805



Item no.: 210-805/000-002
Labels; for Smart Printer; permanent adhesive; 6 x 15 mm; yellow

www.wago.com/210-805/000-002

Marker



Item no.: 2009-145
Mini-WSB Inline; for Smart Printer; 1700 pieces on roll; stretchable 5 - 5.2 mm; plain; snap-on type; white

www.wago.com/2009-145



Item no.: 248-501
Mini-WSB marking card; as card; not stretchable; plain; snap-on type; white

www.wago.com/248-501

Jumpers

Jumper



Item no.: 769-402
Jumper; insulated; gray

www.wago.com/769-402

Cover

Cover

Subject to changes. Please also observe the further product documentation!



Item no.: 769-436
Jumper cover; for 1-conductor female plugs; for 5 poles; gray

www.wago.com/769-436

Locking levers

Locking system



Item no.: 769-430
Locking lever; for female connectors; 1 part; Pin spacing 5 mm; 2-pole; gray

www.wago.com/769-430



Item no.: 769-431
Locking lever; for female connectors; 1 part; Pin spacing 5 mm; 2-pole; orange

www.wago.com/769-431

Strain relief

Strain relief



Item no.: 769-1611
Strain relief housing; for female and male connectors; 2 parts; Pin spacing 5 mm; 11-pole; gray

www.wago.com/769-1611



Item no.: 769-414
Strain relief plate; for female and male connectors; 1 part; Pin spacing 5 mm; 10- to 15-pole; gray

www.wago.com/769-414

Tool

Operating tool



Item no.: 210-490
Operating tool

www.wago.com/210-490



Item no.: 769-434
Operating tool; made of insulating material; 1-way; loose; white

www.wago.com/769-434

Protective warning marker

Cover



Item no.: 280-415
Protective warning marker; for 5 terminal blocks; with high-voltage symbol, black; yellow

www.wago.com/280-415

Testing and measuring

Testing accessories



Item no.: 210-136
Test plug; 2 mm Ø; with 500 mm cable; red

www.wago.com/210-136

Downloads

Documentation

Bid Text

769-111/000-037

2019 Feb 19

xml

Download

Subject to changes. Please also observe the further product documentation!

WAGO GmbH & Co. KG

Hansastr. 27

32423 Minden

Phone: +49571 887-0 | Fax: +49571 887-169

Email: info.de@wago.com | Web: www.wago.com

Do you have any questions about our products?

We are always happy to take your call at +49 (571) 887-44222.



| | | | | |
|-------------------------------|------------|---------|----------|--|
| X81 - Datei | | | 3.3 kB | |
| 769-111/000-037 | 2017 Oct 4 | doc | Download | |
| doc - Datei | | 26.1 kB | | |
| Additional Information | | | | |
| | | pdf | Download | |
| | | 2.3 MB | | |

CAD/CAE-Data

CAE data

| | | | | |
|-----------------------------------|--|-----|----------|--|
| EPLAN Data Portal 769-111/000-037 | | URL | Download | |
| WSCAD Universe 769-111/000-037 | | URL | Download | |
| WSCAD Universe 769-111/000-037 | | URL | Download | |
| EPLAN Data Portal 769-111/000-037 | | URL | Download | |

Environmental Product Compliance

Compliance Search

| | | | | |
|--|--|-----|----------|--|
| Environmental Product Compliance 769-111/000-037 | | URL | Download | |
| 1-conductor female connector; CAGE CLAMP®; 4 mm ² ; Pin spacing 5 mm; 11-pole; coding finger; 4,00 mm ² ; gray, green-yellow | | | | |

Installation Notes

Conductor termination

Subject to changes. Please also observe the further product documentation!

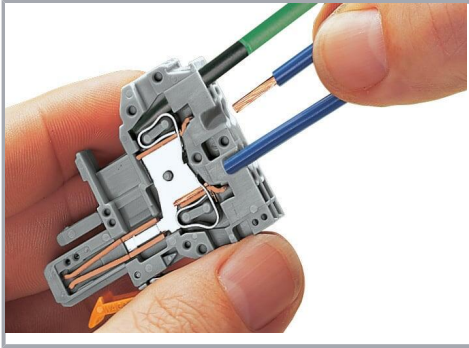

CAGE CLAMP® connection

Female plug: Inserting/removing a conductor via operating tool.

Operation 90° to conductor is also possible. With ferruled conductors, it is necessary to use a terminal block one size smaller than the conductor's nominal cross-section.

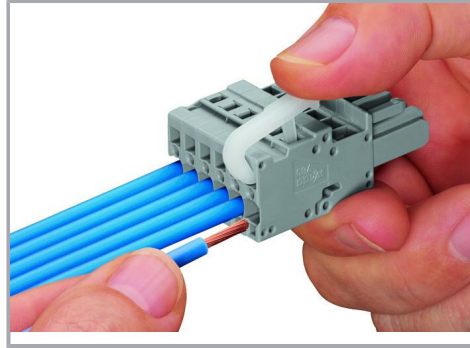

Operating lever

Inserting a conductor – side-entry wiring (example shows a female plug).

Subject to changes. Please also observe the further product documentation!

WAGO GmbH & Co. KG
Hansastr. 27
32423 Minden
Phone: +49571 887-0 | Fax: +49571 887-169
Email: info.de@wago.com | Web: www.wago.com

Do you have any questions about our products?
We are always happy to take your call at +49 (571) 887-44222.

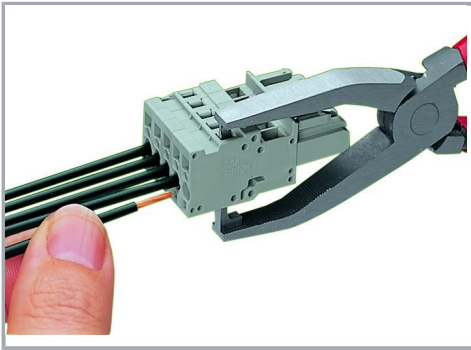

Operating tool

Inserting a conductor – side-entry wiring
(example shows a female plug).

With ferruled conductors, it is necessary to
use a terminal block one size smaller than the
conductor's nominal cross-section.

Commoning

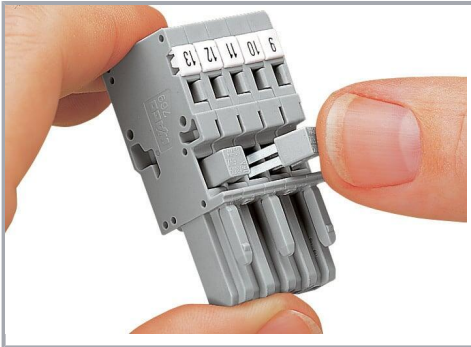

Commoning 1-conductor female plugs via
miniature adjacent jumpers.

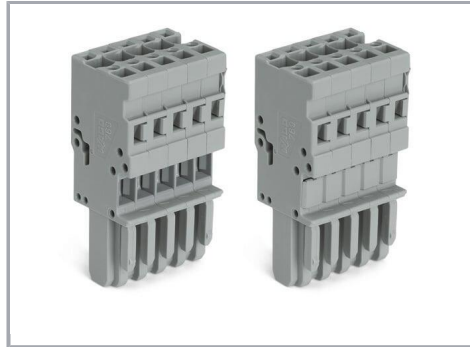

Jumper cover for 1-conductor female plugs

Coding

Subject to changes. Please also observe the further product documentation!



Coding a female plug by removing coding finger(s) via cutting tool. Do not remove the first and last coding fingers or use an additional locking lever.

Locking system

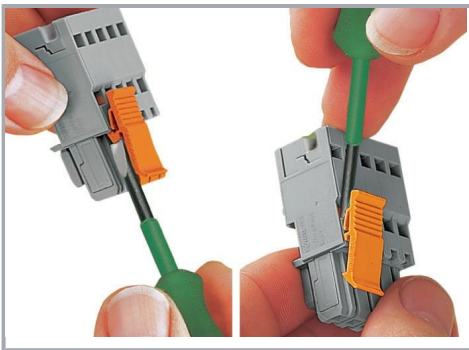

Locking/releasing a lever.

Strain relief

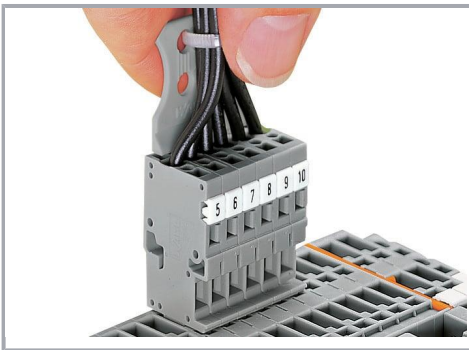

Removing a female plug via conductor bundle provided with strain relief plate.

Marking

Subject to changes. Please also observe the further product documentation!

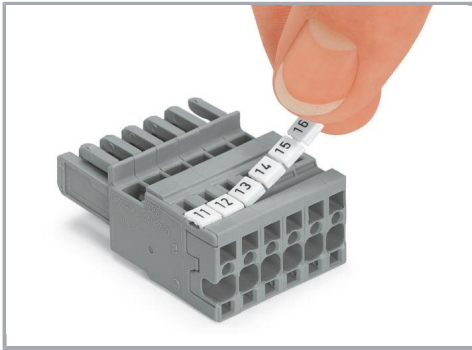

Labeling a female plug with CAGE CLAMP® connection via Mini-WSB Quick Markers.

Product family

X-COM

[Show all products from the family](#)

Subject to changes. Please also observe the further product documentation!