

Data sheet | Item number: 770-843

Socket for PCBs; straight; 3-pole; Cod. B; gray

[www.wago.com/770-843](http://www.wago.com/770-843)

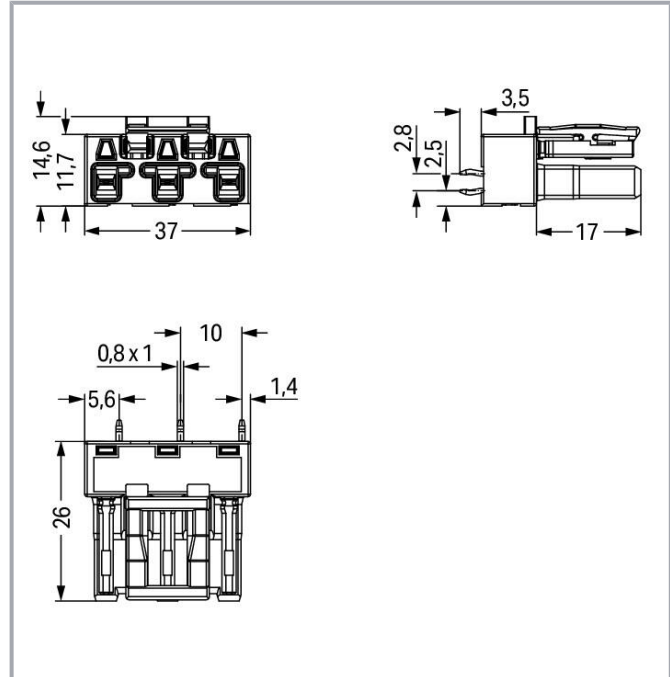
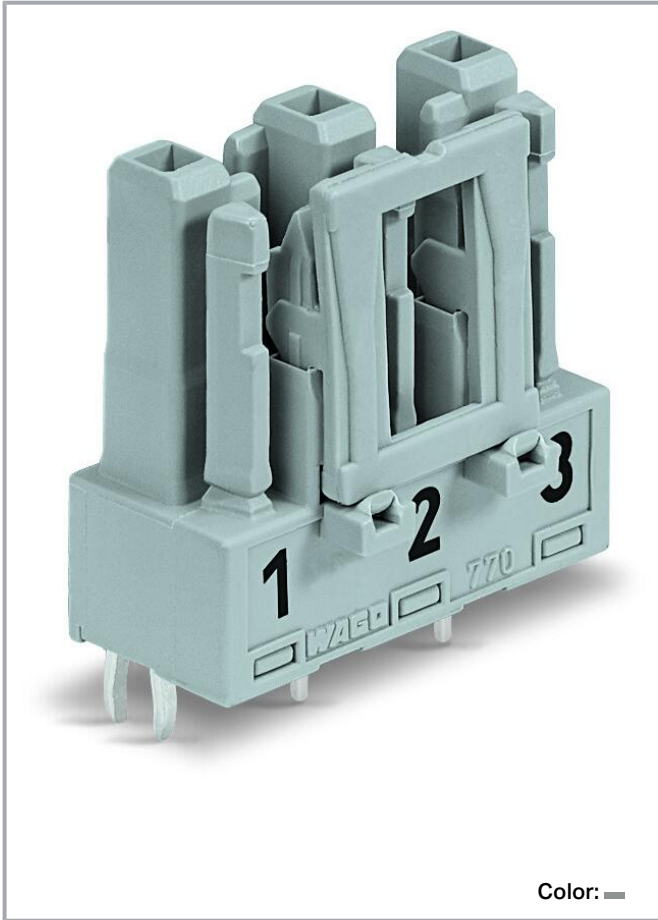

Color: —

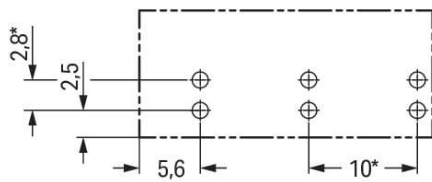

\* ± 0.05 mm  
Drilled hole diameter: 1.5<sup>+0.1</sup> mm

Subject to changes. Please also observe the further product documentation!

WAGO GmbH & Co. KG  
Hansastr. 27  
32423 Minden  
Phone: +49571 887-0 | Fax: +49571 887-169  
Email: [info.de@wago.com](mailto:info.de@wago.com) | Web: [www.wago.com](http://www.wago.com)

Do you have any questions about our products?  
We are always happy to take your call at +49 (571) 887-44222.



## Item description

### Female connector/socket WINSTA® MIDI B coding

The WINSTA® MIDI female connector/socket rated current 25 A saves money and space thanks to its compact dimensions. The pluggable PCB connectors with spring pressure connection technology and Push-in CAGE CLAMP® technology from WAGO allow fast, vibration-proof, maintenance-free terminal connections. The coding options reduce installation errors, allowing fast, maintenance-free wiring of all components. Solutions like the WINSTA® MIDI pcb connectors with B coding are appropriate for applications involving process control, such as for lighting or in data networks. Important parameters in the selection of a pcb connectors are the rated current and voltage: They provide information about possible domains of use and applications. This product has a current rating of 25 A – so it is also suitable for robust loads. WINSTA® MIDI with Push-in CAGE CLAMP® spring pressure connection technology is used in a broad range of individual products you can use for quick, easy, flexible, and secure installation.

### Lower costs through fast commissioning and elimination of service expenses – solutions from WINSTA® MIDI

The WINSTA® Pluggable Connection System is perfectly tailored to the very strict requirements of building installation. It makes electrical installation pluggable, and consequently faster, even more reliable, and error-free. Using this pre-assembled system decreases time spent on assembly and errors during installation at the construction site. Now you can also cut installation expenses without compromising quality and safety: with locking lever reduces the need for servicing and prevents unnecessary downtime.

- effective protection against mismatching
- for automation controllers
- with B coding for use in process automation, such as lighting technology, among other examples
- convenient installation and commissioning

## Data

### Notes

Variants:

Other pole markings

Other versions (or variants) can be requested from WAGO Sales or configured at <https://configurator.wago.com/>.

## Electrical data

### Ratings per IEC/EN

Ratings per	IEC/EN 60664-1
Nominal voltage (III/3)	250 V

Subject to changes. Please also observe the further product documentation!

WAGO GmbH & Co. KG  
Hansastr. 27  
32423 Minden  
Phone: +49571 887-0 | Fax: +49571 887-169  
Email: [info.de@wago.com](mailto:info.de@wago.com) | Web: [www.wago.com](http://www.wago.com)

Do you have any questions about our products?  
We are always happy to take your call at +49 (571) 887-44222.



Rated impulse voltage (III/3)	4 kV
Rated current	25 A
Legend (ratings)	(III / 3) $\triangleq$ Overvoltage category III / Pollution degree 3

### Ratings per UL 1977

Note for the US market	Some versions may also be used for current interruption in accordance with the UL certificate in select applications with currents below 16 A and voltages up to 600 V. For further information, please contact your local sales office.
Rated voltage (UL 1977)	600 V
Rated current UL 1977	23 A

### General information

Note on contact resistance	approx. 1 m $\Omega$ of contact resistance approx. 0.25 m $\Omega$ contact transition plug/socket
----------------------------	--

### Connection data

Total number of potentials	3
Number of levels	1

### Connection 1

Pole number	3
-------------	---

### Physical data

Pin spacing	10 mm / 0.394 inches
Width	27 mm / 1.063 inches
Height	29.5 mm / 1.161 inches
Height from the surface	26 mm / 1.024 inches
Depth	14.6 mm / 0.575 inches
Solder pin length	3.5 mm
Solder pin dimensions	1 x 0.8 mm
Drilled hole diameter with tolerance	1.5 <sup>(-0.1 ... +0.1)</sup> mm

### Mechanical Data

Application	Control technology
Coding	B

Subject to changes. Please also observe the further product documentation!



Variable coding	Yes
Marking	1 2 3
Potential marking	1 2 3
Mating force of a plug-in connection	approx. 20 ... 70 N (depending on pole number)
Retention force of a plug-in connection	Locked: > 80 N
Unmating force of a plug-in connection	Unlocked: approx. 20 ... 70 N (depending on pole number)
Number of mating cycles	200, without resistive load
Design	straight

### Plug-in connection

Contact type (pluggable connector)	Female connector/socket
Connector (connection type)	for PCB
Mismating protection	Yes
Note on mismating protection	All <i>WINSTA</i> <sup>®</sup> components are 100% protected against mismating when: a.) plugging different numbers of poles b.) plugging while rotated 180 c.) plugging while laterally staggered d.) plugging one pole
Mating direction to the PCB	90 °
Locking lever	yes
Locking of plug-in connection	locking lever
Note on locking system	All connectors for mounted installations (snap-in versions for lighting fixtures or devices, all types of PCB and distribution connectors) are factory-equipped with locking levers to ensure plugs and sockets are securely locked. Additional locking levers are only required for flying leads (plug/socket).

### PCB contact

PCB contact	THT
Solder pin arrangement	2 in-line solder pins/pole
Number of solder pins per potential	2

### Material data

Note (material data)	Information on material specifications can be found here
Color	gray
Insulation material	Polyamide (PA66)

Subject to changes. Please also observe the further product documentation!

Flammability class per UL94	V0
Clamping spring material	Chrome-nickel spring steel (CrNi)
Contact material	Copper or copper alloy; surface-treated
Contact plating	Tin
Fire load	0.131 MJ
Weight	6.4 g

### Environmental requirements

Processing temperature	-5 ... +40 °C
Continuous operating temperature	-35 ... +85 °C
Note on continuous operating temperature	Insulating parts for temperatures ≤ 105 °C

### Commercial data

Product Group	20 (Winsta)
eCl@ss 10.0	27-44-06-05
eCl@ss 9.0	27-44-06-05
ETIM 8.0	EC002560
ETIM 7.0	EC002560
ECCN	NO DATA
PU (SPU)	100 pcs
Packaging type	box
Country of origin	PL
GTIN	4017332802314
Customs tariff number	85366990990

### Environmental Product Compliance

RoHS Compliance Status	Compliant, No Exemption
------------------------	-------------------------

### Approvals / Certificates

#### General approvals

Logo	Approval	Additional Approval Text	Certificate name
	CCA DEKRA Certification B.V.	IEC 61984	NL-32104
	CCA DEKRA Certification B.V.	EN 61984	2173495.01

Subject to changes. Please also observe the further product documentation!





cURus  
Underwriters Laboratories Inc.



UL 1977

E45171



Declarations of conformity and manufacturer's declarations

Logo	Approval	Additional Approval Text	Certificate name
	EU-Declaration of Conformity WAGO GmbH & Co. KG	-	-
	UK-Declaration of Conformity WAGO GmbH & Co. KG	-	-

Approvals for marine applications

Logo	Approval	Additional Approval Text	Certificate name
	ABS American Bureau of Shipping	-	19- HG1868589- PDA
	DNV GL Det Norske Veritas, Germanischer Lloyd	-	TAE00001Z6
	LR Lloyds Register	IEC 61984	LR22429487TA

Counterpart

	Item no.770-253 Plug; 3-pole; Cod. B; 4,00 mm <sup>2</sup> ; gray	<a href="http://www.wago.com/770-253">www.wago.com/770-253</a>
	Item no.771-9993/205-103 pre-assembled connecting cable; Eca; Plug/open-ended; 3-pole; Cod. B; H05VV-F 3 x 1.0 mm <sup>2</sup> ; 1 m; 1,00 mm <sup>2</sup> ; gray	<a href="http://www.wago.com/771-9993/205-103">www.wago.com/771-9993/205-103</a>
	Item no.771-9993/005-103 pre-assembled interconnecting cable; Eca; Socket/plug; 3-pole; Cod. B; H05VV-F 3 x 1.0 mm <sup>2</sup> ; 1 m; 1,00 mm <sup>2</sup> ; gray	<a href="http://www.wago.com/771-9993/005-103">www.wago.com/771-9993/005-103</a>

Subject to changes. Please also observe the further product documentation!

WAGO GmbH & Co. KG  
Hansastr. 27  
32423 Minden  
Phone: +49571 887-0 | Fax: +49571 887-169  
Email: [info.de@wago.com](mailto:info.de@wago.com) | Web: [www.wago.com](http://www.wago.com)

Do you have any questions about our products?  
We are always happy to take your call at +49 (571) 887-44222.

## Required accessories

### Cover

#### Cover



Item no.: 770-201

Lockout cap; 12-pole, separable; for sockets; Plastic; black

[www.wago.com/770-201](http://www.wago.com/770-201)



Item no.: 770-221

Lockout cap; 12-pole, separable; for sockets; Plastic; white

[www.wago.com/770-221](http://www.wago.com/770-221)

## Downloads

### CAD/CAE-Data

#### CAD data

2D/3D Models 770-843

[URL](#)

[Download](#)

#### CAE data

EPLAN Data Portal 770-843

[URL](#)

[Download](#)

ZUKEN Portal 770-843

[URL](#)

[Download](#)

#### PCB Design

Symbol and Footprint 770-843

[URL](#)

[Download](#)

CAX data for your PCB design, consisting of "schematic symbols and PCB footprints", allow easy integration of the WAGO component into your development environment.

#### Supported formats:

- Accel EDA 14 & 15
- Altium 6 to current version
- Cadence Allegro
- DesignSpark
- Eagle Libraries
- KiCad
- Mentor Graphics BoardStation
- Mentor Graphics Design Architect
- Mentor Graphics Design Expedition 99 and 2000
- OrCAD 9.X PCB and Capture

Subject to changes. Please also observe the further product documentation!

WAGO GmbH & Co. KG

Hansastr. 27

32423 Minden

Phone: +49571 887-0 | Fax: +49571 887-169

Email: [info.de@wago.com](mailto:info.de@wago.com) | Web: [www.wago.com](http://www.wago.com)

Do you have any questions about our products?

We are always happy to take your call at +49 (571) 887-44222.



- PADS PowerPCB 3, 3.5, 4.X, and 5.X
- PADS PowerPCB and PowerLogic 3.0
- PCAD 2000, 2001, 2002, 2004, and 2006
- Pulsonix 8.5 or newer
- STL
- 3D STEP
- TARGET 3001!
- View Logic ViewDraw
- Quadcept
- Zuken CadStar 3 and 4
- Zuken CR-5000 and CR-8000

PCB Component Libraries (EDA), PCB CAD Library Ultra Librarian

---

#### Asset Administration Shell

Asset Administration Shell 770-843	<a href="#">URL</a>	<a href="#">Download</a>
------------------------------------	---------------------	--------------------------

---

#### Environmental Product Compliance

##### Compliance Search

Environmental Product Compliance 770-843 Socket for PCBs; straight; 3-pole; Cod. B; gray	<a href="#">URL</a>	<a href="#">Download</a>
---	---------------------	--------------------------

---

#### Installation Notes

#### Product family

**WINSTA® MIDI**  
[Show all products from the family](#)

Subject to changes. Please also observe the further product documentation!