

## Item description

### Male connector/plug *WINSTA*® MINI rated current 16 A

The *WINSTA*® MINI male connector/plug with protection against mismatching supports rapid, correct installation. On PCBs, in control cabinets or for connecting lights – pluggable installation connectors from WAGO allow you to establish connections according to a huge variety of requirements in no time flat. The coding options reduce installation errors, allowing fast, secure wiring of all components. Coding in blue is used to identify *WINSTA*® MINI pluggable installation connectors, which are used predominantly in automation of buildings for controlling lighting. Thanks to its particularly compact dimensions, our *WINSTA*® MINI Pluggable Connection System with Push-in CAGE CLAMP® spring pressure connection technology is specifically suitable in very tight spaces, i.e., for installations when very little room is available.

### *WINSTA*® MINI solutions for your electrical installation – protected against mismatching and maintenance-free

*WINSTA*® is the pluggable connection system that is ideally tailored to the strict requirements of electrical installation. It allows fast, secure and, above all, error-free installation of components and cables. Now you can also lower installation costs without compromising safety and quality: with protection type IP20 reduces the need for servicing and prevents unnecessary downtime.

■

—  
Subject to changes. Please also observe the further product documentation!



- protection against mismatching eliminates errors
- compact design for conductors with a cross-section up to 1.5 mm<sup>2</sup>
- with I coding for controlling light (DALI standard)
- custom-engineered solutions
- convenient installation and commissioning

## Data

### Electrical data

#### Ratings per IEC/EN

Ratings per	IEC/EN 60664-1
Nominal voltage (III/3)	250 V
Rated impulse voltage (III/3)	4 kV
Rated current	16 A
Legend (ratings)	(III / 3) ≙ Overvoltage category III / Pollution degree 3

#### Ratings per UL 1977

Note for the US market	Some versions may also be used for current interruption in accordance with the UL certificate in select applications with currents below 5 A and voltages up to 600 V. For further information, please contact your local sales office.
Rated voltage (UL 1977)	600 V
Rated current UL 1977	14 A

### General information

Note on contact resistance	approx. 1 mΩ of contact resistance approx. 0.25 mΩ contact transition plug/socket
----------------------------	--

### Connection data

Connection points	2
Total number of potentials	2

### Connection 1

Connection technology	Push-in CAGE CLAMP®
Actuation type	Operating tool Push-in
Nominal cross-section	1.5 mm <sup>2</sup> / 16 AWG

Subject to changes. Please also observe the further product documentation!



Solid conductor	0.25 ... 1.5 mm <sup>2</sup> / 22 ... 16 AWG
Solid conductor; push-in termination	0.75 ... 1.5 mm <sup>2</sup> / 20 ... 16 AWG
Stranded conductor	0.25 ... 1 mm <sup>2</sup> / 22 ... 18 AWG
Fine-stranded conductor	0.25 ... 1.5 mm <sup>2</sup> / 22 ... 16 AWG
Fine-stranded conductor; with insulated ferrule	0.25 ... 0.75 mm <sup>2</sup> / 22 ... 20 AWG
Fine-stranded conductor; with uninsulated ferrule	0.25 ... 0.75 mm <sup>2</sup> / 22 ... 20 AWG
Fine-stranded conductor; with ferrule; push-in termination	0.75 mm <sup>2</sup> / 20 AWG
Strip length	9 mm / 0.35 inches
Pole number	2
Conductor entry direction to mating direction	0°

### Physical data

Pin spacing	4.4 mm / 0.173 inches
Width	10.4 mm / 0.409 inches
Height	11.7 mm / 0.461 inches
Depth	34.1 mm / 1.343 inches

### Mechanical Data

Application	DALI, Lighting Management
Coding	I
Variable coding	No
Marking	- ±
Potential marking	- ±
Mating force of a plug-in connection	approx. 20 ... 70 N (depending on pole number)
Retention force of a plug-in connection	Locked: > 80 N
Unmating force of a plug-in connection	Unlocked: approx. 20 ... 70 N (depending on pole number)
Number of mating cycles	200, without resistive load
Protection type	IP20; IP40 when mated with strain relief housing

### Plug-in connection

Contact type (pluggable connector)	Male connector/plug
Connector (connection type)	for conductor
Mismating protection	Yes
Note on mismating protection	All WINSTA <sup>®</sup> components are 100% protected against mismating when: a.) plugging different numbers of poles b.) plugging while rotated 180

Subject to changes. Please also observe the further product documentation!



	c.) plugging while laterally staggered d.) plugging one pole
Locking lever	Can be retrofitted
Locking of plug-in connection	locking lever
Note on locking system	All connectors for mounted installations (snap-in versions for lighting fixtures or devices, all types of PCB and distribution connectors) are factory-equipped with locking levers to ensure plugs and sockets are securely locked. Additional locking levers are only required for flying leads (plug/socket).

## Material data

Note (material data)	Information on material specifications can be found here
Color	blue
Cover color	gray
Material group	I
Insulation material	Polyamide (PA66)
Flammability class per UL94	V0
Clamping spring material	Chrome-nickel spring steel (CrNi)
Contact material	Copper or copper alloy; surface-treated
Contact plating	Tin
Fire load	0.08 MJ
Weight	2.5 g

## Environmental requirements

Processing temperature	-5 ... +40 °C
Continuous operating temperature	-35 ... +85 °C
Note on continuous operating temperature	Insulating parts for temperatures $\leq 105$ °C

## Commercial data

Product Group	20 (Winsta)
eCl@ss 10.0	27-44-06-05
eCl@ss 9.0	27-44-06-05
ETIM 8.0	EC002560
ETIM 7.0	EC002560
ECCN	NO DATA
PU (SPU)	50 pcs

Subject to changes. Please also observe the further product documentation!

WAGO GmbH & Co. KG  
 Hansastr. 27  
 32423 Minden  
 Phone: +49571 887-0 | Fax: +49571 887-169  
 Email: [info.de@wago.com](mailto:info.de@wago.com) | Web: [www.wago.com](http://www.wago.com)

Do you have any questions about our products?  
 We are always happy to take your call at +49 (571) 887-44222.

Packaging type	box
Country of origin	PL
GTIN	4055143548502
Customs tariff number	85366990990

## Environmental Product Compliance



RoHS Compliance Status	Compliant, No Exemption
------------------------	-------------------------

## Approvals / Certificates

### General approvals

Logo	Approval	Additional Approval Text	Certificate name
	CCA DEKRA Certification B.V.	IEC 61535	NL-85020
	CCA DEKRA Certification B.V.	EN 61535	71-123231
	cURus Underwriters Laboratories Inc.	UL 1977	E45171

### Declarations of conformity and manufacturer's declarations

Logo	Approval	Additional Approval Text	Certificate name
	EU-Declaration of Conformity WAGO GmbH & Co. KG	-	-
	UK-Declaration of Conformity WAGO GmbH & Co. KG	-	-

### Approvals for marine applications

Logo	Approval	Additional Approval Text	Certificate name
	ABS American Bureau of Shipping	Steel Vessel Rules	19-HG1869855-PDA

Subject to changes. Please also observe the further product documentation!

WAGO GmbH & Co. KG  
 Hansastr. 27  
 32423 Minden  
 Phone: +49571 887-0 | Fax: +49571 887-169  
 Email: [info.de@wago.com](mailto:info.de@wago.com) | Web: [www.wago.com](http://www.wago.com)

Do you have any questions about our products?  
 We are always happy to take your call at +49 (571) 887-44222.



**DNV GL**  
Det Norske Veritas, Germanischer Lloyd

TAE00001Z6



**LR**  
Lloyds Register

EN 61535

08/20047  
(E2)

## Counterpart



**Item no.890-1102**  
Socket; 2-pole; Cod. I; 1,50 mm<sup>2</sup>; blue

[www.wago.com/890-1102](http://www.wago.com/890-1102)

**Item no.890-1617**  
T-distribution connector; 2-pole; Cod. I; 1 input; 2 outputs; 2 locking levers; blue

[www.wago.com/890-1617](http://www.wago.com/890-1617)

**Item no.890-1620**  
T-distribution connector; 2-pole; Cod. I; 1 input; 2 outputs; 3 locking levers; for flying leads; blue

[www.wago.com/890-1620](http://www.wago.com/890-1620)

**Item no.890-1904**  
3-way distribution connector; 2-pole; Cod. I; 1 input; 3 outputs; blue

[www.wago.com/890-1904](http://www.wago.com/890-1904)

**Item no.890-1907**  
5-way distribution connector; 2-pole; Cod. I; 1 input; 5 outputs; blue

[www.wago.com/890-1907](http://www.wago.com/890-1907)

**Item no.890-2102**  
Snap-in socket; 2-pole; Cod. I; 1,50 mm<sup>2</sup>; blue

[www.wago.com/890-2102](http://www.wago.com/890-2102)

**Item no.890-3102**  
Socket for PCBs; straight; 2-pole; Cod. I; blue

[www.wago.com/890-3102](http://www.wago.com/890-3102)

**Item no.890-3102/011-000**  
Socket for PCBs; angled; 2-pole; Cod. I; blue

[www.wago.com/890-3102/011-000](http://www.wago.com/890-3102/011-000)

**Item no.891-8982/006-101**  
pre-assembled interconnecting cable; Eca; Socket/plug; 2-pole; Cod. I; H05VV-F 2 x 1.5 mm<sup>2</sup>; 1 m; 1,50 mm<sup>2</sup>; blue

[www.wago.com/891-8982/006-101](http://www.wago.com/891-8982/006-101)

**Item no.891-8982/106-101**  
pre-assembled connecting cable; Eca; Socket/open-ended; 2-pole; Cod. I; H05VV-F 2 x 1.5 mm<sup>2</sup>; 1 m; 1,50 mm<sup>2</sup>; blue

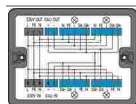
[www.wago.com/891-8982/106-101](http://www.wago.com/891-8982/106-101)

**Item no.899-631/181-000**  
Distribution box; 230 V + DALI; 2 inputs; 6 outputs; Cod. A, I; MINI, MIDI; black

[www.wago.com/899-631/181-000](http://www.wago.com/899-631/181-000)

Subject to changes. Please also observe the further product documentation!

WAGO GmbH & Co. KG  
Hansastr. 27  
32423 Minden  
Phone: +49571 887-0 | Fax: +49571 887-169  
Email: [info.de@wago.com](mailto:info.de@wago.com) | Web: [www.wago.com](http://www.wago.com)

Do you have any questions about our products?  
We are always happy to take your call at +49 (571) 887-44222.

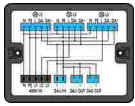

**Item no.899-631/455-000**  
Distribution box; 400 V + DALI; 2 inputs; 5 outputs; Cod. A, I; MINI, MIDI; black

[www.wago.com/899-631/455-000](http://www.wago.com/899-631/455-000)

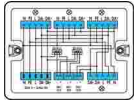

**Item no.899-681/146-000**  
Distribution box; 230 V + DALI; 1 input; 7 outputs; Cod. I; MINI, MIDI; white

[www.wago.com/899-681/146-000](http://www.wago.com/899-681/146-000)

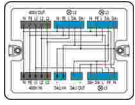

**Item no.899-681/147-000**  
Distribution box; 400 V + DALI; 2 inputs; 5 outputs; Cod. A, I; MINI, MIDI; white

[www.wago.com/899-681/147-000](http://www.wago.com/899-681/147-000)

## Required accessories

### Locking levers

#### Locking system



**Item no.: 890-111**  
Locking lever; for flying leads; for tool operation; black

[www.wago.com/890-111](http://www.wago.com/890-111)



**Item no.: 890-101**  
Locking lever; for manual operation; black

[www.wago.com/890-101](http://www.wago.com/890-101)



**Item no.: 890-121**  
Locking lever; for manual operation; white

[www.wago.com/890-121](http://www.wago.com/890-121)



**Item no.: 890-131**  
Locking lever; for flying leads; for tool operation; white

[www.wago.com/890-131](http://www.wago.com/890-131)

### Strain relief

#### Strain relief housing



**Item no.: 890-502**  
Strain relief housing; 2-pole; with locking clip; for 1 cable; 3.8 ... 8.2 mm; 30 mm; black

[www.wago.com/890-502](http://www.wago.com/890-502)



**Item no.: 890-502/342-000**  
Strain relief housing; 2-pole; with locking clip; for 1 cable; 3.8 ... 8.2 mm; 17.5 mm; black

[www.wago.com/890-502/342-000](http://www.wago.com/890-502/342-000)



**Item no.: 890-512**  
Strain relief housing; 2-pole; with locking clip; for 1 cable; 3.8 ... 8.2 mm; 30 mm; white

[www.wago.com/890-512](http://www.wago.com/890-512)



**Item no.: 890-512/342-000**  
Strain relief housing; 2-pole; with locking clip; for 1 cable; 3.8 ... 8.2 mm; 17.5 mm; white

[www.wago.com/890-512/342-000](http://www.wago.com/890-512/342-000)

Subject to changes. Please also observe the further product documentation!

## Optional accessories

### Cover

Cover



**Item no.: 897-2001**

Protective cap; Type1; for sockets and plugs; PVC; red

[www.wago.com/897-2001](http://www.wago.com/897-2001)

### Mounting

Mounting accessories



**Item no.: 890-310**

Mounting carrier; 2- to 5-pole; for flying leads; black

[www.wago.com/890-310](http://www.wago.com/890-310)



**Item no.: 890-311**

Mounting carrier; 2- to 5-pole; for flying leads; white

[www.wago.com/890-311](http://www.wago.com/890-311)

### Tool

Operating tool



**Item no.: 210-719**

Operating tool; Blade: 2.5 x 0.4 mm; with a partially insulated shaft

[www.wago.com/210-719](http://www.wago.com/210-719)



**Item no.: 890-382**

Operating tool; 2-way; green

[www.wago.com/890-382](http://www.wago.com/890-382)

## Downloads

### Documentation

#### Bid Text

890-1112 X81 - Datei	2019 Feb 19	xml 3.0 kB	Download
890-1112 doc - Datei	2015 Jun 8	doc 23.6 kB	Download

### CAD/CAE-Data

#### CAD data

2D/3D Models 890-1112	URL	Download
-----------------------	-----	----------

Subject to changes. Please also observe the further product documentation!

WAGO GmbH & Co. KG  
 Hansastr. 27  
 32423 Minden  
 Phone: +49571 887-0 | Fax: +49571 887-169  
 Email: [info.de@wago.com](mailto:info.de@wago.com) | Web: [www.wago.com](http://www.wago.com)

Do you have any questions about our products?  
 We are always happy to take your call at +49 (571) 887-44222.



## CAE data

EPLAN Data Portal 890-1112	<a href="#">URL</a>	<a href="#">Download</a>
ZUKEN Portal 890-1112	<a href="#">URL</a>	<a href="#">Download</a>
WSCAD Universe 890-1112	<a href="#">URL</a>	<a href="#">Download</a>

## Asset Administration Shell

Asset Administration Shell 890-1112	<a href="#">URL</a>	<a href="#">Download</a>
-------------------------------------	---------------------	--------------------------

## Environmental Product Compliance

### Compliance Search

Environmental Product Compliance 890-1112 Plug; 2-pole; Cod. I; 1,50 mm <sup>2</sup> ; blue	<a href="#">URL</a>	<a href="#">Download</a>
--	---------------------	--------------------------

## Installation Notes

### Conductor termination

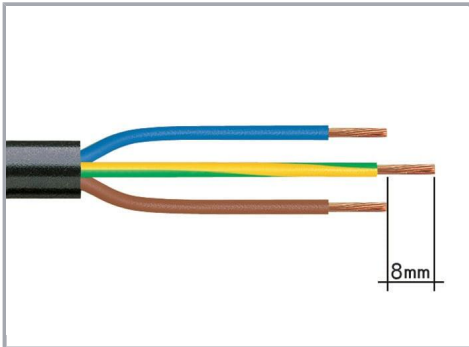

1. Strip length, outer insulation = 30 mm (2-pole), 37 mm (3-pole), 45 mm (4- and 5-pole)
2. Strip length = 9 mm
3. Extended ground conductor = 8 mm

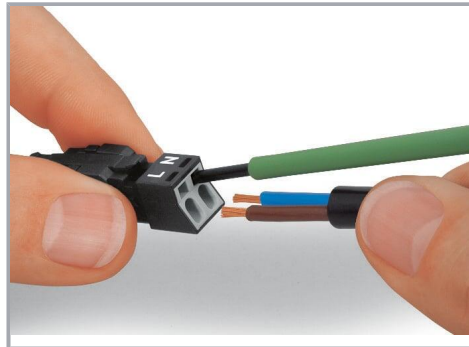

To terminate fine-stranded conductors, open the clamping unit via screwdriver – 2.5 mm blade width – and insert a stripped conductor until it hits the backstop. Terminate solid conductors by simply pushing them in.

Subject to changes. Please also observe the further product documentation!

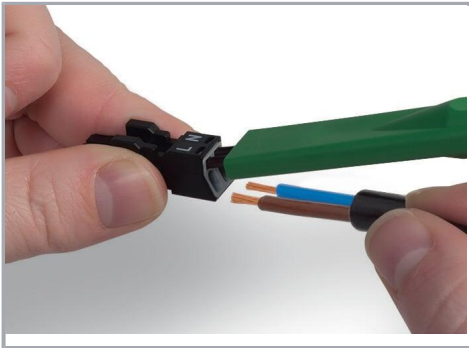

To terminate fine-stranded conductors, open clamping units via operating tool (890-382) and insert stripped conductors until they hit backstop. Terminate solid conductors by simply pushing them in.

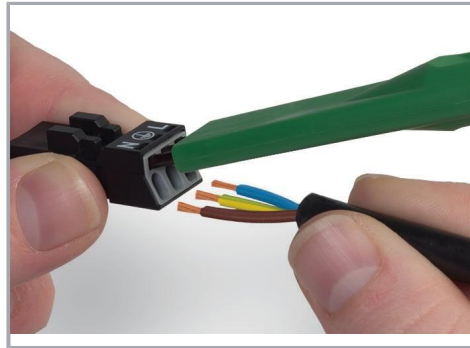

To terminate fine-stranded conductors, open clamping units via operating tool (890-383) and insert stripped conductors until they hit backstop. Terminate solid conductors by simply pushing them in.

### Installation

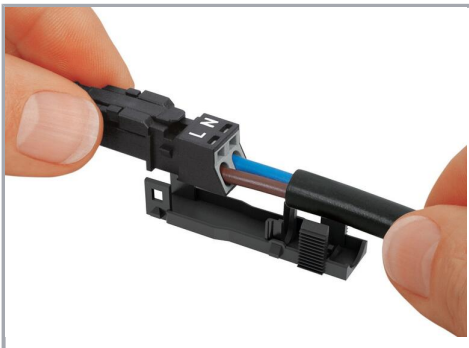

Latch the wired connector into the base of the strain relief housing.



Push down strain relief clamp by hand.



Push down strain relief clamp with 2.5 mm screwdriver alternately on both sides.



Latch the top of the strain relief housing.

Subject to changes. Please also observe the further product documentation!



The printed marking of the connector is clearly visible in the openings of the strain relief housing.

### Product family

**WINSTA® MINI**

[Show all products from the family](#)

Subject to changes. Please also observe the further product documentation!