

Data sheet | Item number: 733-107

1-conductor female connector; CAGE CLAMP®; 0.5 mm²; Pin spacing 2.5 mm; 7-pole; 100% protected against mismatching; 0,50 mm²; light gray

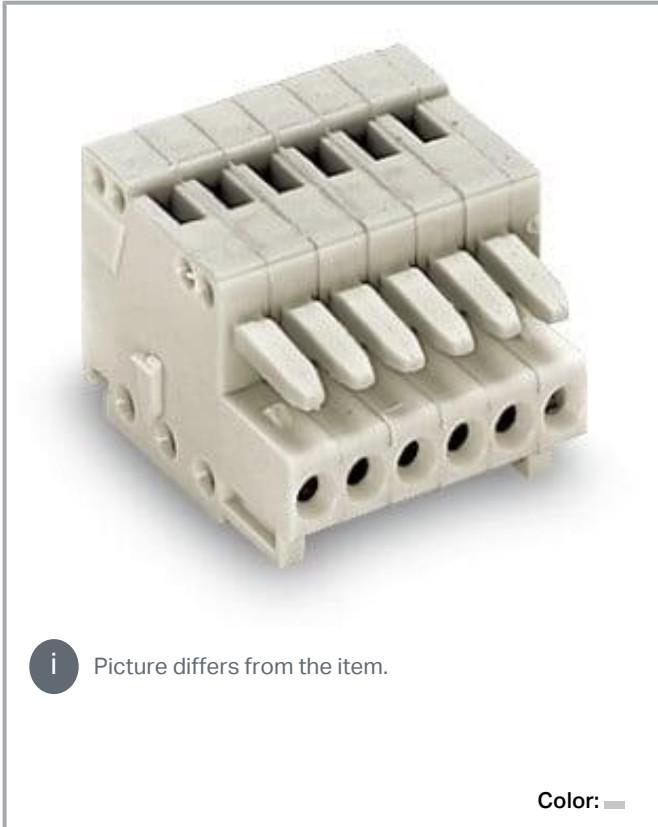

www.wago.com/733-107



i Picture differs from the item.

Color:

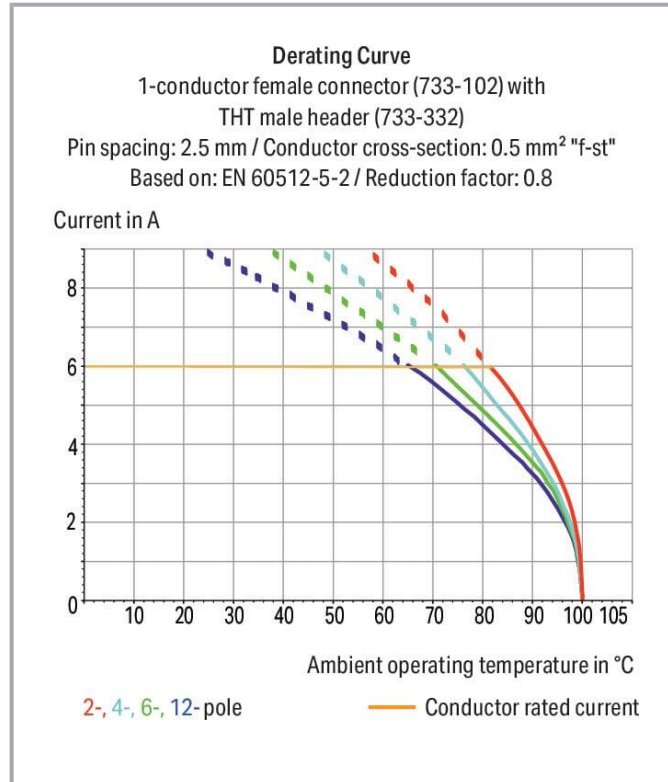

Subject to changes. Please also observe the further product documentation!

WAGO GmbH & Co. KG
Hansastr. 27
32423 Minden
Phone: +49571 887-0 | Fax: +49571 887-169
Email: info.de@wago.com | Web: www.wago.com

Do you have any questions about our products?
We are always happy to take your call at +49 (571) 887-44222.

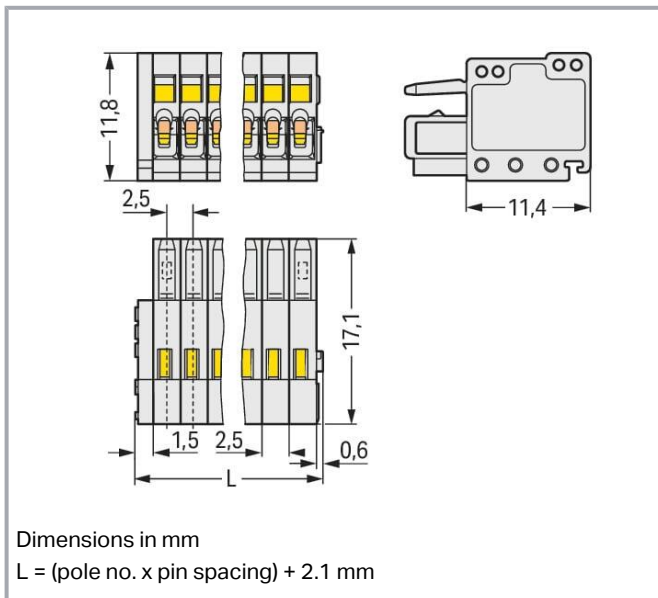

Item description

- Universal connection for all conductor types
- Easy cable pre-assembly and on-unit wiring via vertical and horizontal CAGE CLAMP® actuation
- Strain relief plates for factory and field assembly
- 100% protected against mismatching
- Coding option available

Data

Notes

Safety information

The *MCS – MULTI CONNECTION SYSTEM* includes connectors without breaking capacity in accordance with DIN EN 61984. When used as intended, these connectors must not be connected /disconnected when live or under load. When used as intended, these connectors must not be connected/disconnected when live or under load. The circuit design should ensure header pins, which can be touched, are not live when unmated.

Variants:

Other pole numbers
Gold-plated or partially gold-plated contact surfaces
Other versions (or variants) can be requested from WAGO Sales or configured at <https://configurator.wago.com/>.

Electrical data

Subject to changes. Please also observe the further product documentation!

WAGO GmbH & Co. KG
Hansastr. 27
32423 Minden
Phone: +49571 887-0 | Fax: +49571 887-169
Email: info.de@wago.com | Web: www.wago.com

Do you have any questions about our products?
We are always happy to take your call at +49 (571) 887-44222.

Ratings per IEC/EN

Ratings per	IEC/EN 60664-1
Nominal voltage (III/3)	100 V
Rated impulse voltage (III/3)	2.5 kV
Rated voltage (III/2)	160 V
Rated impulse voltage (III/2)	2.5 kV
Nominal voltage (II/2)	320 V
Rated surge voltage (II/2)	2.5 kV
Rated current	6 A
Legend (ratings)	(III / 2) ≙ Overvoltage category III / Pollution degree 2

Ratings per UL

Approvals per	UL 1059
Rated voltage UL (Use Group B)	150 V
Rated current UL (Use Group B)	4 A

Ratings per CSA

Approvals per	CSA
Rated voltage CSA (Use Group B)	150 V
Rated current CSA (Use Group B)	4 A

Connection data

Connection points	7
Total number of potentials	7
Number of connection types	1
Number of levels	1

Connection 1

Connection technology	CAGE CLAMP®
Actuation type	Operating tool
Actuation direction 1	Operation parallel to conductor entry
Actuation direction 2	Operation perpendicular to conductor entry
Solid conductor	0.08 ... 0.5 mm ² / 28 ... 20 AWG
Fine-stranded conductor	0.08 ... 0.5 mm ² / 28 ... 20 AWG
Fine-stranded conductor; with insulated ferrule	0.25 ... 0.34 mm ²
Fine-stranded conductor; with uninsulated ferrule	0.25 ... 0.34 mm ²

Subject to changes. Please also observe the further product documentation!



Strip length	5 ... 6 mm / 0.2 ... 0.24 inches
Pole number	7
Conductor entry direction to mating direction	0°

Physical data

Pin spacing	2.5 mm / 0.098 inches
Width	19.6 mm / 0.772 inches
Height	11.8 mm / 0.465 inches
Depth	17.1 mm / 0.673 inches

Mechanical Data

Variable coding	Yes
Anti-rotation protection	Yes

Plug-in connection

Contact type (pluggable connector)	Female connector/socket
Connector (connection type)	for conductor
Mismating protection	Yes
Plugging without loss of pin spacing	No
Locking of plug-in connection	none

Material data

Note (material data)	Information on material specifications can be found here
Color	light gray
Material group	I
Insulation material	Polyamide (PA66)
Flammability class per UL94	V0
Clamping spring material	Chrome-nickel spring steel (CrNi)
Contact material	Copper alloy
Contact plating	Tin
Fire load	0.055 MJ
Weight	3.1 g

Subject to changes. Please also observe the further product documentation!

Environmental requirements

Limit temperature range	-60 ... +100 °C
Processing temperature	-35 ... +60 °C

Commercial data



Product Group	3 (Multi Conn. System)
eCl@ss 10.0	27-44-03-09
eCl@ss 9.0	27-44-03-09
ETIM 8.0	EC002638
ETIM 7.0	EC002638
ECCN	NO DATA
PU (SPU)	100 pcs
Packaging type	box
Country of origin	DE
GTIN	4044918294096
Customs tariff number	85366990990

Environmental Product Compliance

RoHS Compliance Status	Compliant, No Exemption
------------------------	-------------------------

Approvals / Certificates

General approvals

Logo	Approval	Additional Approval Text	Certificate name
	CCA DEKRA Certification B.V.	EN 61984	2169534.01
	CCA DEKRA Certification B.V.	IEC 61984	NL-31141
	CSA DEKRA Certification B.V.	C22.2	1465035
	UL UL International Germany GmbH	UL 1977	E45171

Subject to changes. Please also observe the further product documentation!



UL
Underwriters Laboratories Inc.



UL 1059

E45172

Declarations of conformity and manufacturer's declarations

Logo	Approval	Additional Approval Text	Certificate name
	Railway WAGO GmbH & Co. KG	-	Railway Ready

Approvals for marine applications

Logo	Approval	Additional Approval Text	Certificate name
	ABS American Bureau of Shipping	-	19- HG1869876- PDA
	DNV DNV GL SE	-	TAE000016Z
	LR Lloyds Register	IEC 61984	96/20035 (E5)

Counterpart



Item no.733-207

1-conductor male connector; CAGE CLAMP®; 0.5 mm²; Pin spacing 2.5 mm; 7-pole; 100% protected against mismatching; 0,50 mm²; light gray

www.wago.com/733-207

Item no.733-207/033-000

1-conductor male connector; CAGE CLAMP®; 0.5 mm²; Pin spacing 2.5 mm; 7-pole; 100% protected against mismatching; Strain relief plate; 0,50 mm²; light gray

www.wago.com/733-207/033-000

Item no.733-337/105-604

THR male header; 0.8 x 0.8 mm solder pin; straight; 100% protected against mismatching; Pin spacing 2.5 mm; 7-pole; black

www.wago.com/733-337/105-604

Subject to changes. Please also observe the further product documentation!

WAGO GmbH & Co. KG

Hansastr. 27





32423 Minden

Phone: +49571 887-0 | Fax: +49571 887-169







Email: info.de@wago.com | Web: www.wago.com

Do you have any questions about our products?

We are always happy to take your call at +49 (571) 887-44222.

	Item no.733-337 THT male header; 0.8 x 0.8 mm solder pin; straight; 100% protected against mismatching; Pin spacing 2.5 mm; 7-pole; light gray	www.wago.com/733-337
	Item no.733-337/105-604/997-446 THR male header; 0.8 x 0.8 mm solder pin; straight; 100% protected against mismatching; in tape-and-reel packaging; Pin spacing 2.5 mm; 7-pole; black	www.wago.com/733-337/105-604/997-446
	Item no.733-367/105-604 THR male header; 0.8 x 0.8 mm solder pin; angled; 100% protected against mismatching; Pin spacing 2.5 mm; 7-pole; black	www.wago.com/733-367/105-604
	Item no.733-367 THT male header; 0.8 x 0.8 mm solder pin; angled; 100% protected against mismatching; Pin spacing 2.5 mm; 7-pole; light gray	www.wago.com/733-367
	Item no.733-367/105-604/997-406 THR male header; 0.8 x 0.8 mm solder pin; angled; 100% protected against mismatching; in tape-and-reel packaging; Pin spacing 2.5 mm; 7-pole; black	www.wago.com/733-367/105-604/997-406

Optional accessories

Ferrule		
Ferrule		
	Item no.: 216-132 Ferrule; Sleeve for 0.34 mm ² / AWG 24; uninsulated; electro-tin plated	www.wago.com/216-132
	Item no.: 216-131 Ferrule; Sleeve for 0.25 mm ² / AWG 24; uninsulated; electro-tin plated; silver-colored	www.wago.com/216-131
	Item no.: 216-152 Ferrule; Sleeve for 0.34 mm ² / AWG 24; uninsulated; electro-tin plated	www.wago.com/216-152
	Item no.: 216-151 Ferrule; Sleeve for 0.25 mm ² / AWG 24; uninsulated; electro-tin plated	www.wago.com/216-151
	Item no.: 216-301 Ferrule; Sleeve for 0.25 mm ² / AWG 24; insulated; electro-tin plated; yellow	www.wago.com/216-301
	Item no.: 216-321 Ferrule; Sleeve for 0.25 mm ² / AWG 24; insulated; electro-tin plated; yellow	www.wago.com/216-321
	Item no.: 216-322 Ferrule; Sleeve for 0.34 mm ² / 22 AWG; insulated; electro-tin plated; light turquoise	www.wago.com/216-322
	Item no.: 216-302 Ferrule; Sleeve for 0.34 mm ² / 22 AWG; insulated; electro-tin plated; light turquoise	www.wago.com/216-302

Marking accessories

Marking strip		
	Item no.: 210-331/250-207	

Subject to changes. Please also observe the further product documentation!



Marking strips; as a DIN A4 sheet; MARKED; 1-48 (100x); Height of marker strip: 2.3 mm/0.091 in; Strip length 182 mm; Horizontal marking; Self-adhesive; white

www.wago.com/210-331/250-207



Item no.: 210-331/250-202

Marking strips; as a DIN A4 sheet; MARKED; 1-16 (400x); Height of marker strip: 2.3 mm/0.091 in; Strip length 182 mm; Horizontal marking; Self-adhesive; white

www.wago.com/210-331/250-202



Item no.: 210-331/250-204

Marking strips; as a DIN A4 sheet; MARKED; 17-32 (400x); Height of marker strip: 2.3 mm/0.091 in; Strip length 182 mm; Horizontal marking; Self-adhesive; white

www.wago.com/210-331/250-204



Item no.: 210-331/250-206

Marking strips; as a DIN A4 sheet; MARKED; 33-48 (400x); Height of marker strip: 2.3 mm/0.091 in; Strip length 182 mm; Horizontal marking; Self-adhesive; white

www.wago.com/210-331/250-206

Strain relief

Strain relief plate



Item no.: 734-128

Strain relief plate; for female and male connectors; 12.5 mm wide; 1 part; Pin spacing 3.5 mm; light gray

www.wago.com/734-128

Tool

Operating tool



Item no.: 210-251

Operating tool; for MCS MICRO and MINI with CAGE CLAMP® connection; yellow

www.wago.com/210-251



Item no.: 210-719

Operating tool; Blade: 2.5 x 0.4 mm; with a partially insulated shaft

www.wago.com/210-719



Item no.: 233-332

Operating tool; made of insulating material; white

www.wago.com/233-332



Item no.: 233-331

Operating tool; insulated; yellow

www.wago.com/233-331



Item no.: 233-335

Operating tool; green

www.wago.com/233-335



Item no.: 733-191

Operating tool; made of insulating material; 1-way; loose; yellow

www.wago.com/733-191



Item no.: 733-130

Operating tool; made of insulating material; 1-way; loose; white

www.wago.com/733-130

Testing and measuring

Testing accessories

Subject to changes. Please also observe the further product documentation!

WAGO GmbH & Co. KG

Hansastr. 27

32423 Minden

Phone: +49571 887-0 | Fax: +49571 887-169

Email: info.de@wago.com | Web: www.wago.com

Do you have any questions about our products?

We are always happy to take your call at +49 (571) 887-44222.



Item no.: 735-500

WAGO Test pin; 1 mm Ø; 30 V AC / 60 V DC; CAT0; 1 A; 6 mm uninsulated; Test lead for soldering up to 0,5mm² www.wago.com/735-500

Downloads

Documentation

Additional Information

Technical Section	2019 Apr 3	pdf	Download
Technical explanations		2.1 MB	

CAD/CAE-Data

CAD data

2D/3D Models 733-107	URL	Download
----------------------	-----	----------

CAE data

EPLAN Data Portal 733-107	URL	Download
---------------------------	-----	----------

ZUKEN Portal 733-107	URL	Download
----------------------	-----	----------

Asset Administration Shell

Asset Administration Shell 733-107	URL	Download
------------------------------------	-----	----------

Environmental Product Compliance

Compliance Search

Environmental Product Compliance 733-107	URL	Download
--	-----	----------

1-conductor female connector; CAGE CLAMP®; 0.5 mm²; Pin spacing 2.5 mm; 7-pole; 100% protected against mismatching; 0,50 mm²; light gray

Installation Notes

Mismatching protection

Subject to changes. Please also observe the further product documentation!

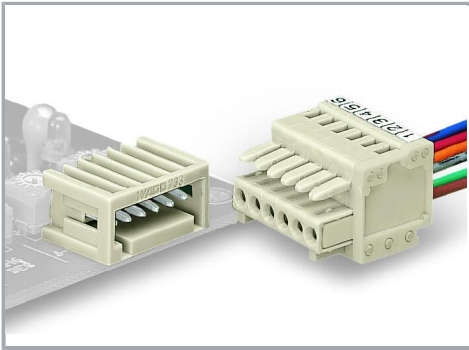

Male headers and female connectors are 100% protected against mismatching. Only mating halves with the same pole number can be connected.

Conductor termination

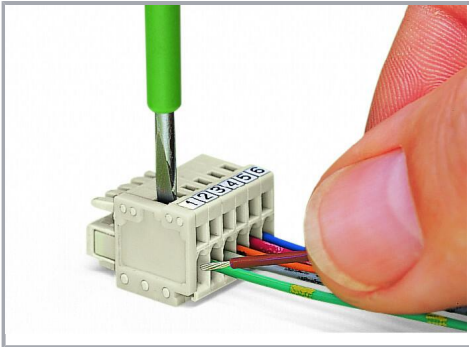

Inserting conductor via (2.5 x 0.4) mm screwdriver – CAGE CLAMP® actuation perpendicular to conductor entry.

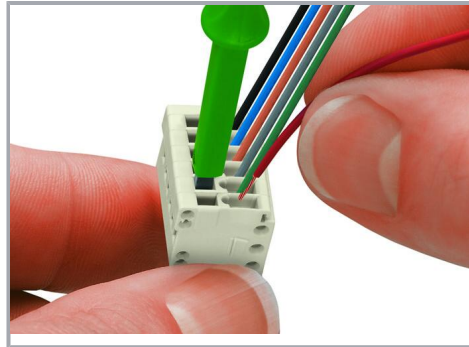

Conductor termination via screwdriver (233-335) – parallel to CAGE CLAMP® actuation

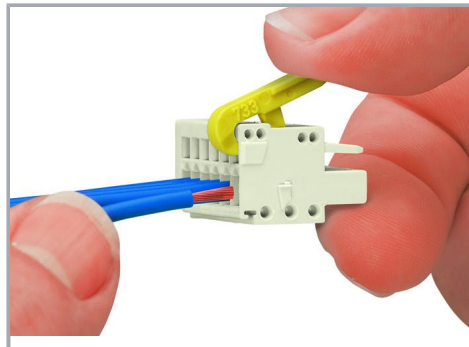
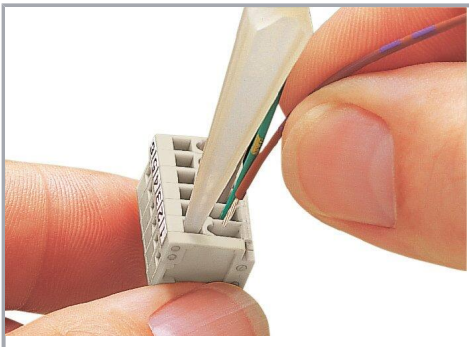

Conductor termination via operating tool (733-191)

Subject to changes. Please also observe the further product documentation!

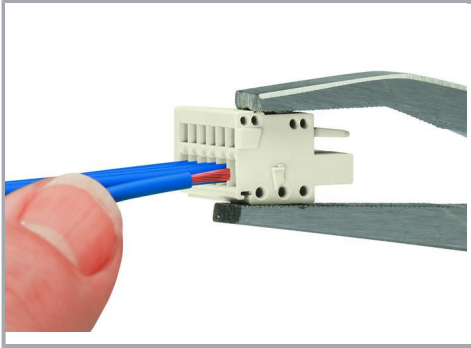

Conductor termination via operating tool (210-251)

Coding

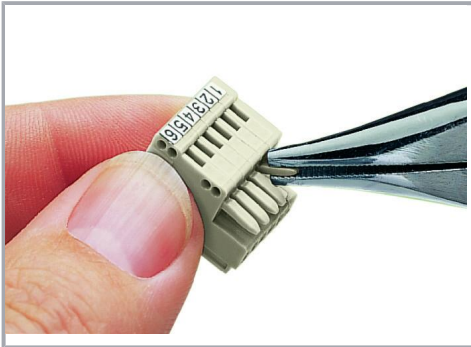

Coding a female connector – removing coding finger(s).

Marking

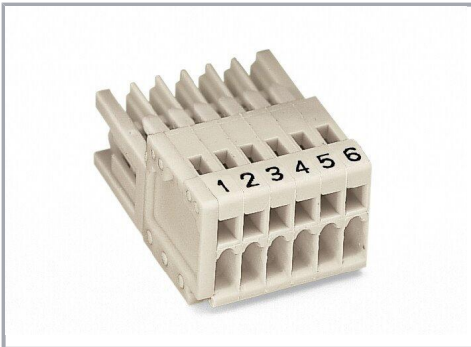

Strain relief

Subject to changes. Please also observe the further product documentation!

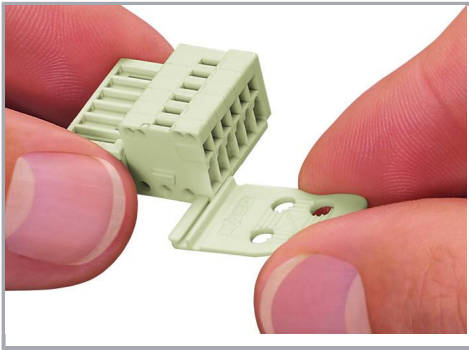

Strain relief plates for factory or in-the-field assembly

Testing

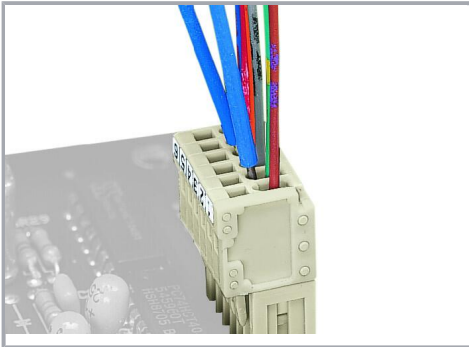

Testing via 1 mm Ø test pin (735-500), touch contact.

Product family

MCS MICRO

[Show all products from the family](#)

Subject to changes. Please also observe the further product documentation!