

Data sheet | Item number: 770-254
Plug; 4-pole; Cod. B; 4,00 mm²; gray

www.wago.com/770-254

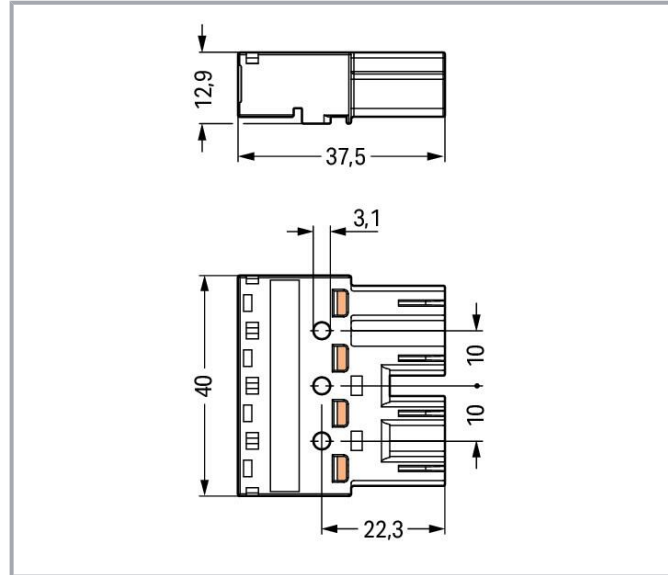
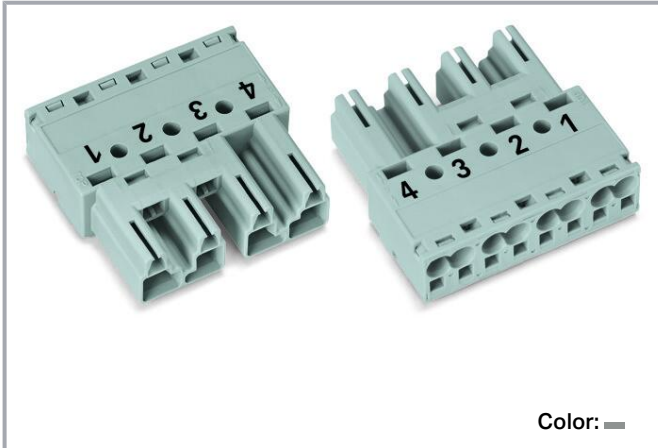

Item description

Male connector/plug *WINSTA*® MIDI B coding

The *WINSTA*® MIDI male connector/plug with protection type IP20 provides the foundation for installation of solid and fine-stranded conductors. WAGO pluggable installation connectors can be used when specifications repeat or are planned on a defined grid, for example for installing grid lighting or flush-mount lighting. The mechanical coding and color coding of the pluggable installation connector ensure error-free installation of the individual components – including protection against mismatching. The pluggable installation connector offers protection against contact with live components in accordance with protection type IP20 (When mated and secured with a strain relief housing: IP2xC (These compact connectors are not designed for use in open, easily accessible areas!)). Pluggable installation connectors with B coding from the *WINSTA*® MIDI line are available in gray, light green, or pink, allowing you to distinguish different circuits, for example for pumps, lighting, or sun blinds. Your own pole marking is possible, too. This pluggable installation connector is designed for a current load of up to 25 A. Therefore, it can also be used for high power loads. *WINSTA*® MIDI with Push-in CAGE CLAMP® spring pressure connection technology is used in a broad range of individual products you can use for quick, easy, flexible, and secure electrical installation.

Push-in CAGE CLAMP® spring pressure connection technology – pluggable installation instead of laborious screw connections!

Subject to changes. Please also observe the further product documentation!

WAGO GmbH & Co. KG
Hansastr. 27
32423 Minden
Phone: +49571 887-0 | Fax: +49571 887-169
Email: info.de@wago.com | Web: www.wago.com

Do you have any questions about our products?
We are always happy to take your call at +49 (571) 887-44222.



The WINSTA® Pluggable Connection System is perfectly tailored to the strict requirements of building installation. It makes electrical installation pluggable, and consequently faster, even more reliable, and error-free. Use of this pre-assembled system decreases assembly times and errors during installation at the construction site. Now you can also cut installation costs without compromising quality and safety: with marking reduces the need for servicing and prevents unnecessary downtime.

- effective protection against mismatching
- simple circuits
- with B coding for use in process automation, such as lighting technology
- ready to install and use immediately
- quick replacement of defective units during ongoing operation

Data Notes

Variants:

Other pole markings

Other versions (or variants) can be requested from WAGO Sales or configured at <https://configurator.wago.com/>.

Electrical data

Ratings per IEC/EN

Ratings per	IEC/EN 60664-1
Nominal voltage (III/3)	400 V
Rated impulse voltage (III/3)	6 kV
Rated current	25 A
Legend (ratings)	(III / 3) ≙ Overvoltage category III / Pollution degree 3

Ratings per IEC/EN – Notes

Note (rated current)

25 A for 3-pole load
20 A for 4-pole load

Ratings per UL 1977

Note for the US market

Some versions may also be used for current interruption in accordance with the UL certificate in select applications with currents below 16 A and voltages up to 600 V. For further information, please contact your local sales office.

Rated voltage (UL 1977)	600 V
Rated current UL 1977	23 A

Subject to changes. Please also observe the further product documentation!

WAGO GmbH & Co. KG
Hansastr. 27
32423 Minden
Phone: +49571 887-0 | Fax: +49571 887-169
Email: info.de@wago.com | Web: www.wago.com

Do you have any questions about our products?
We are always happy to take your call at +49 (571) 887-44222.



General information

Note on contact resistance	approx. 1 mΩ of contact resistance approx. 0.25 mΩ contact transition plug/socket
----------------------------	--

Connection data

Connection points	8
Total number of potentials	4

Connection 1

Connection technology	Push-in CAGE CLAMP®
Actuation type	Operating tool Push-in
Nominal cross-section	4 mm ² / 12 AWG
Solid conductor	0.5 ... 4 mm ² / 20 ... 12 AWG
Solid conductor; push-in termination	1.5 ... 4 mm ² / 16 ... 12 AWG
Stranded conductor	0.5 ... 2.5 mm ² / 20 ... 14 AWG
Fine-stranded conductor	0.5 ... 4 mm ² / 20 ... 12 AWG
Fine-stranded conductor; with insulated ferrule	0.25 ... 1.5 mm ² / 20 ... 16 AWG
Fine-stranded conductor; with uninsulated ferrule	0.25 ... 2.5 mm ² / 20 ... 14 AWG
Fine-stranded conductor; with ferrule; push-in termination	1.5 mm ² / 16 AWG
Strip length	9 mm / 0.35 inches
Pole number	4
Conductor entry direction to mating direction	0°

Physical data

Pin spacing	10 mm / 0.394 inches
Width	40 mm / 1.575 inches
Height	12.9 mm / 0.508 inches
Depth	37.5 mm / 1.476 inches

Mechanical Data

Application	Control technology
Coding	B
Variable coding	Yes
Marking	4 3 2 1
Potential marking	4 3 2 1

Subject to changes. Please also observe the further product documentation!

WAGO GmbH & Co. KG
Hansastr. 27
32423 Minden
Phone: +49571 887-0 | Fax: +49571 887-169
Email: info.de@wago.com | Web: www.wago.com

Do you have any questions about our products?
We are always happy to take your call at +49 (571) 887-44222.



Mating force of a plug-in connection	approx. 20 ... 70 N (depending on pole number)
Retention force of a plug-in connection	Locked: > 80 N
Unmating force of a plug-in connection	Unlocked: approx. 20 ... 70 N (depending on pole number)
Number of mating cycles	200, without resistive load
Protection type	IP20; When mated and secured with a strain relief housing: IP2xC (These compact connectors are not designed for use in open, easily accessible areas!)

Plug-in connection

Contact type (pluggable connector)	Male connector/plug
Connector (connection type)	for conductor
Mismating protection	Yes
Note on mismating protection	All <i>WINSTA</i> [®] components are 100% protected against mismating when: a.) plugging different numbers of poles b.) plugging while rotated 180 c.) plugging while laterally staggered d.) plugging one pole
Locking lever	Can be retrofitted
Locking of plug-in connection	locking lever
Note on locking system	All connectors for mounted installations (snap-in versions for lighting fixtures or devices, all types of PCB and distribution connectors) are factory-equipped with locking levers to ensure plugs and sockets are securely locked. Additional locking levers are only required for flying leads (plug/socket).

Material data

Note (material data)	Information on material specifications can be found here
Color	gray
Cover color	gray
Material group	I
Insulation material	Polyamide (PA66)
Flammability class per UL94	V0
Clamping spring material	Chrome-nickel spring steel (CrNi)
Contact material	Copper or copper alloy; surface-treated
Contact plating	Tin
Fire load	0.357 MJ
Weight	13 g

Subject to changes. Please also observe the further product documentation!

Environmental requirements

Processing temperature	-5 ... +40 °C
Continuous operating temperature	-35 ... +85 °C
Note on continuous operating temperature	Insulating parts for temperatures ≤ 105 °C

Commercial data



Product Group	20 (Winsta)
eCl@ss 10.0	27-44-06-05
eCl@ss 9.0	27-44-06-05
ETIM 8.0	EC002560
ETIM 7.0	EC002560
ECCN	NO DATA
PU (SPU)	50 pcs
Packaging type	box
Country of origin	DE
GTIN	4044918253970
Customs tariff number	85366990990

Environmental Product Compliance

RoHS Compliance Status	Compliant, No Exemption
------------------------	-------------------------

Approvals / Certificates



General approvals

Logo	Approval	Additional Approval Text	Certificate name
	CCA DEKRA Certification B.V.	EN 61984	2173495.01
	CCA DEKRA Certification B.V.	IEC 61984	NL-32104
	cURus Underwriters Laboratories Inc.	UL 1977	E45171
	cURus Underwriters Laboratories Inc.	UL 1059	E 45172



Subject to changes. Please also observe the further product documentation!



Declarations of conformity and manufacturer's declarations

Logo	Approval	Additional Approval Text	Certificate name
	EU-Declaration of Conformity WAGO GmbH & Co. KG	-	-
	UK-Declaration of Conformity WAGO GmbH & Co. KG	-	-

Approvals for marine applications

Logo	Approval	Additional Approval Text	Certificate name
	ABS American Bureau of Shipping	-	19- HG1868589- PDA
	DNV GL Det Norske Veritas, Germanischer Lloyd	-	TAE00001Z6
	LR Lloyds Register	IEC 61984	LR22429487TA

Counterpart



Item no.770-1631

T-distribution connector; 4-pole; Cod. B; 1 input; 2 outputs; 2 locking levers; gray

www.wago.com/770-1631

Item no.770-1731

T-distribution connector; 4-pole; Cod. B; 1 input; 2 outputs; 3 locking levers; for flying leads; gray

www.wago.com/770-1731

Subject to changes. Please also observe the further product documentation!

WAGO GmbH & Co. KG

Hansastr. 27

32423 Minden

Phone: +49571 887-0 | Fax: +49571 887-169

Email: info.de@wago.com | Web: www.wago.com

Do you have any questions about our products?

We are always happy to take your call at +49 (571) 887-44222.



Item no.770-1681

h-distribution connector; 4-pole; Cod. B; 1 input; 2 outputs; outputs on one side; 2 locking levers; gray www.wago.com/770-1681

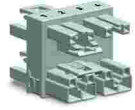

Item no.770-1734

3-way distribution connector; 4-pole; Cod. B; 1 input; 3 outputs; gray

www.wago.com/770-1734



Item no.770-1781

h-distribution connector; 4-pole; Cod. B; 1 input; 2 outputs; outputs on one side; 3 locking levers; for flying leads; gray www.wago.com/770-1781



Item no.770-244

Socket; 4-pole; Cod. B; 4,00 mm²; gray

www.wago.com/770-244



Item no.770-744

Snap-in socket; 4-pole; Cod. B; 4,00 mm²; gray

www.wago.com/770-744



Item no.770-844

Socket for PCBs; straight; 4-pole; Cod. B; gray

www.wago.com/770-844



Item no.770-844/011-000

Socket for PCBs; angled; 4-pole; Cod. B; gray

www.wago.com/770-844/011-000



Item no.771-9994/005-103

pre-assembled interconnecting cable; Eca; Socket/plug; 4-pole; Cod. B; Control cable 4 x 1.0 mm²; 1 m; 1,00 mm²; gray

www.wago.com/771-9994/005-103



Item no.771-9994/105-103

pre-assembled connecting cable; Eca; Socket/open-ended; 4-pole; Cod. B; Control cable 4 x 1.0 mm²; 1 m; 1,00 mm²; gray

www.wago.com/771-9994/105-103

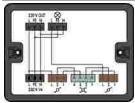

Item no.899-631/305-000

Distribution box; Crossover switching; 1 input; 5 outputs; Cod. A, B, S; MIDI; black

www.wago.com/899-631/305-000

Required accessories

Locking levers

Locking system



Item no.: 770-121

Locking lever; for flying leads; for manual operation; white

www.wago.com/770-121



Item no.: 770-131

Locking lever; for flying leads; for tool operation; white

www.wago.com/770-131



Item no.: 770-101

Locking lever; for flying leads; for manual operation; black

www.wago.com/770-101

Subject to changes. Please also observe the further product documentation!

WAGO GmbH & Co. KG

Hansastr. 27

32423 Minden

Phone: +49571 887-0 | Fax: +49571 887-169

Email: info.de@wago.com | Web: www.wago.com

Do you have any questions about our products?

We are always happy to take your call at +49 (571) 887-44222.



Item no.: 770-111
Locking lever; for flying leads; for tool operation; black

www.wago.com/770-111

Strain relief

Strain relief housing



Item no.: 770-504/023-000
Strain relief housing; 4-pole; for 2 cables; 5.0 ... 9.0 mm; 55 mm; black

www.wago.com/770-504/023-000



Item no.: 770-514
Strain relief housing; 4-pole; for 2 cables; 9.0 ... 13.0 mm; 55 mm; white

www.wago.com/770-514



Item no.: 770-504
Strain relief housing; 4-pole; for 2 cables; 9.0 ... 13.0 mm; 55 mm; black

www.wago.com/770-504



Item no.: 770-514/023-000
Strain relief housing; 4-pole; for 2 cables; 5.0 ... 9.0 mm; 55 mm; white

www.wago.com/770-514/023-000

Optional accessories

Strain relief

Strain relief housing



Item no.: 770-504/020-000
Strain relief housing; 4-pole; for 1 cable; 11.5 ... 16.5 mm; 71 mm; black

www.wago.com/770-504/020-000

Marking accessories

Marker



Item no.: 770-450/000-002
Marker card; Plastic; yellow

www.wago.com/770-450/000-002



Item no.: 770-450/000-001
Marker card; Plastic; green

www.wago.com/770-450/000-001



Item no.: 770-450/000-005
Marker card; Plastic; red

www.wago.com/770-450/000-005



Item no.: 770-450
Marker card; Plastic; white

www.wago.com/770-450



Item no.: 770-450/000-006
Marker card; Plastic; blue

www.wago.com/770-450/000-006

Subject to changes. Please also observe the further product documentation!



Item no.: 770-450/000-012
Marker card; Plastic; orange

www.wago.com/770-450/000-012

Cover

Cover



Item no.: 770-360
Lockout cap; for plugs; 5-pole; separable; yellow

www.wago.com/770-360



Item no.: 897-2005
Protective cap; Type4; for sockets and plugs; PVC; red

www.wago.com/897-2005

Mounting

Mounting accessories



Item no.: 770-319
Snap-in frame; 4-pole; 1.0 ... 3.0 mm; black

www.wago.com/770-319



Item no.: 770-339
Snap-in frame; 4-pole; 1.0 ... 3.0 mm; white

www.wago.com/770-339

Tool

Operating tool



Item no.: 210-719
Operating tool; Blade: 2.5 x 0.4 mm; with a partially insulated shaft

www.wago.com/210-719

Downloads

Documentation

Bid Text

770-254 X81 - Datei	2019 Feb 19	xml 3.0 kB	Download
770-254 doc - Datei	2015 Jun 8	doc 24.6 kB	Download

CAD/CAE-Data

CAE data

EPLAN Data Portal 770-254	URL	Download
---------------------------	-----	----------

WSCAD Universe 770-254

Subject to changes. Please also observe the further product documentation!

[URL](#) [Download](#)

ZUKEN Portal 770-254

[URL](#) [Download](#)

CAD data

2D/3D Models 770-254

[URL](#) [Download](#)

Asset Administration Shell

Asset Administration Shell 770-254

[URL](#) [Download](#)

Environmental Product Compliance

Compliance Search

Environmental Product Compliance 770-254

[URL](#) [Download](#)

Plug; 4-pole; Cod. B; 4,00 mm²; gray

Installation Notes

Conductor termination

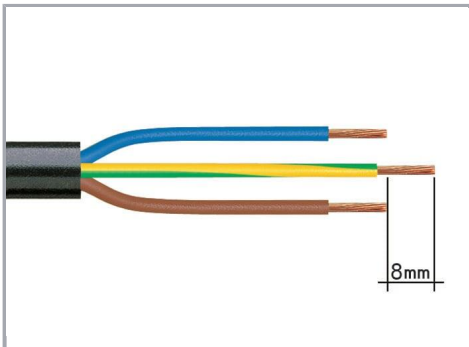

1. Strip length, outer insulation = 35 mm (2-pole), 55 mm (3- to 5-pole)
2. Strip length = 9 mm
3. Extended ground conductor = 8 mm

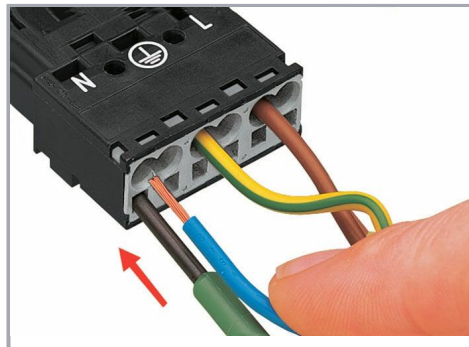

To terminate fine-stranded conductors, open the clamping unit via screwdriver (2.5 mm blade width) and insert a stripped conductor until it hits the backstop.

Subject to changes. Please also observe the further product documentation!

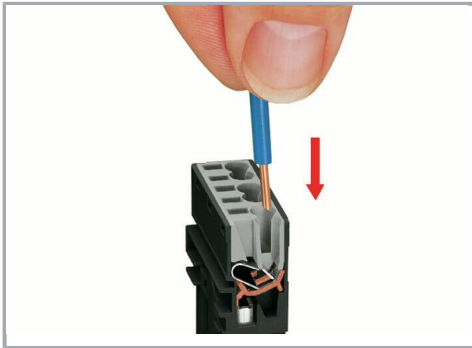

Insert the stripped solid conductor until it hits the backstop.

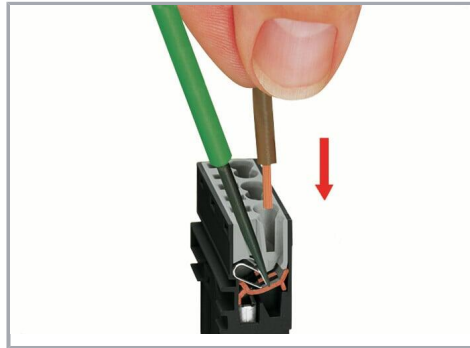

To terminate fine-stranded conductors, open the clamping unit via screwdriver (2.5 mm blade width) and insert a stripped conductor until it hits the backstop.

Conductor removal

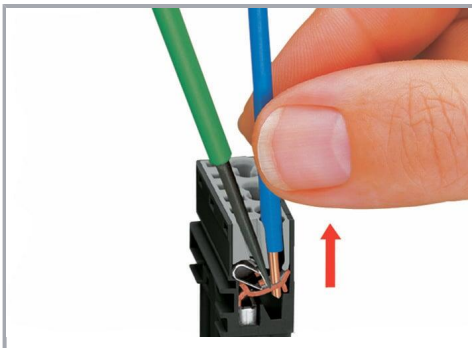

To remove the conductor, actuate the clamp via screwdriver (2.5 mm blade width) and pull out the conductor.

Installation

Subject to changes. Please also observe the further product documentation!

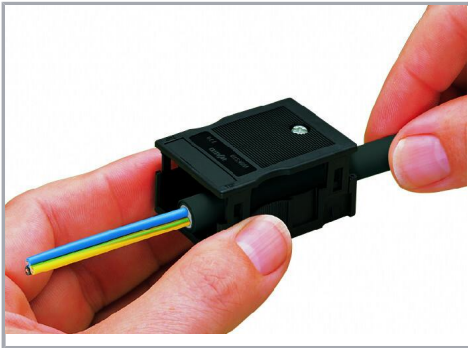

We recommend pulling the pre-latched strain relief housing over the cable prior to termination. However, the strain relief can be mounted at a later time as well.

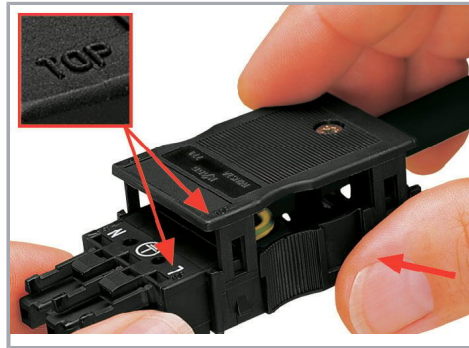

Latch the strain relief housing onto the plug /socket. Note the "TOP" inscription.

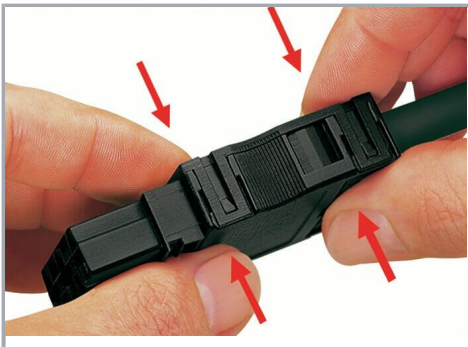

Prepare strain relief housing by snapping together upper and bottom part.



Tighten strain relief screw with screwdriver (2.5 mm blade width).

Coding



Simply cut off the coding pin from the socket.

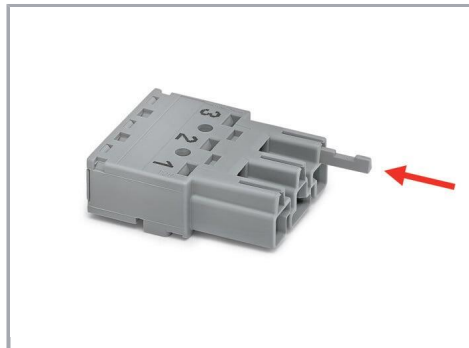

Insert coding pin into plug (break first) until it engages.

Mismatching protection

Subject to changes. Please also observe the further product documentation!

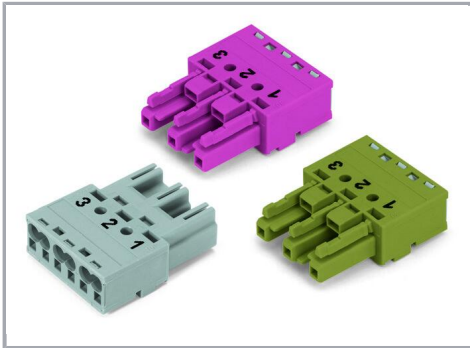

B-coded connectors with different colors can be plugged together.

Important note:

Different colors and/or pole markings are used for circuit identification.

Only connectors of the same color and same pole marking must be plugged together.

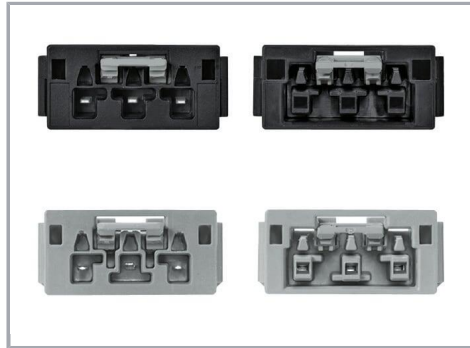

B-coded connectors (shown in gray) not only differ in color, but also in their design, making them incompatible with other coded connectors.



Easy circuit identification via different marking and colors

Product family

WINSTA® MIDI

[Show all products from the family](#)

Subject to changes. Please also observe the further product documentation!