

Item description

Distribution connector *WINSTA*® MINI with protection against mismatching

The *WINSTA*® MINI distribution connector with protection against mismatching is the pluggable solution for your use in control cabinets, on PCBs or for lighting connections. WAGO pluggable installation connectors are used when specifications repeat or are planned on a specified grid, for example for installing grid lighting or flush-mount lighting. The coding options reduce installation errors, allowing fast, maintenance-free wiring of all components. Thanks to the color coding and mechanical A coding of *WINSTA*® MINI pluggable installation connectors, you can clearly distinguish different circuits. Where space is tight, our smallest pluggable connection system, *WINSTA*® MINI, consistently displays its advantageous properties. It saves space, and, with Push-in CAGE CLAMP® spring pressure connection technology, it also saves time, since the connection is low-maintenance and can be performed without screw connections.

Push-in CAGE CLAMP® spring pressure connection technology – pluggable installation instead of laborious screw connections!

The *WINSTA*® Pluggable Connection System is perfectly tailored to the strict requirements of building installation. It makes electrical installation pluggable, and thus faster, more reliable, and error-free. Use of this pre-assembled system decreases time spent on assembly and installation errors at the construction site. Take advantage of the pluggable version of our maintenance-free spring pressure connection technology too! Plan

Subject to changes. Please also observe the further product documentation!



your installation with with protection type IP20 from WAGO.

-
- pluggable installation connectors with protection against mismatching
- easy tool-free operation, a wide range of coding options
- with A coding for a large number of uses
- ready to install and use immediately
- fast, secure installation

Data Notes

Note	At least one snap-in connector WITHOUT a locking lever is required on one side when connecting two lights directly via intermediate coupler.
------	---

Electrical data

Ratings per IEC/EN

Ratings per	IEC/EN 60664-1
Nominal voltage (III/3)	400 V
Rated impulse voltage (III/3)	6 kV
Rated current	16 A
Legend (ratings)	(III / 3) ≙ Overvoltage category III / Pollution degree 3

Ratings per UL 1977

Note for the US market	Some versions may also be used for current interruption in accordance with the UL certificate in select applications with currents below 5 A and voltages up to 600 V. For further information, please contact your local sales office.
Rated voltage (UL 1977)	600 V
Rated current UL 1977	12 A

General information

Note on contact resistance	approx. 1 mΩ of contact resistance approx. 0.25 mΩ contact transition plug/socket
----------------------------	--

Subject to changes. Please also observe the further product documentation!



Connection data

Total number of potentials	5
----------------------------	---

Connection 1

Pole number	5
-------------	---

Physical data

Pin spacing	4.4 mm / 0.173 inches
Width	23.65 mm / 0.931 inches
Height	10.5 mm / 0.413 inches
Depth	37.2 mm / 1.465 inches

Mechanical Data

Application	General mains applications
Coding	A
Variable coding	No
Marking	plain
Mating force of a plug-in connection	approx. 20 ... 70 N (depending on pole number)
Retention force of a plug-in connection	When locked: > 80 N
Unmating force of a plug-in connection	Unlocked: approx. 20 ... 70 N (depending on pole number)
Number of mating cycles	200, without resistive load
Type of distribution box	Intermediate coupler
Protection type	IP20; IP40 when mated

Plug-in connection

Contact type (pluggable connector)	Socket/plug
Mismating protection	Yes
Note on mismating protection	All WINSTA [®] components are 100% protected against mismating when: a.) plugging different numbers of poles b.) plugging while rotated 180 c.) plugging while laterally staggered d.) plugging one pole
Locking lever	yes
Locking of plug-in connection	locking lever
Note on locking system	All connectors for mounted installations (snap-in versions for

Subject to changes. Please also observe the further product documentation!



lighting fixtures or devices, all types of PCB and distribution connectors) are factory-equipped with locking levers to ensure plugs and sockets are securely locked. Additional locking levers are only required for flying leads (plug/socket).

Material data

Note (material data)

Information on material specifications can be found here

Color	black
Insulation material	Polyamide (PA66)
Flammability class per UL94	V0
Contact material	Copper or copper alloy; surface-treated
Contact plating	Tin
Fire load	0.094 MJ
Weight	5.8 g

Environmental requirements

Processing temperature	-5 ... +40 °C
Continuous operating temperature	-35 ... +85 °C
Note on continuous operating temperature	Insulating parts for temperatures ≤ 105 °C

Commercial data

Product Group	20 (Winsta)
eCl@ss 10.0	27-44-06-03
eCl@ss 9.0	27-44-06-03
ETIM 8.0	EC002567
ETIM 7.0	EC002567
ECCN	NO DATA
PU (SPU)	50 pcs
Packaging type	box
Country of origin	PL
GTIN	4050821295433
Customs tariff number	85366990990



Environmental Product Compliance

RoHS Compliance Status	Compliant, No Exemption
------------------------	-------------------------



Subject to changes. Please also observe the further product documentation!

Approvals / Certificates



General approvals

Logo	Approval	Additional Approval Text	Certificate name
	CCA DEKRA Certification B.V.	IEC 61535	NL-85020
	CCA DEKRA Certification B.V.	EN 61535	71- 123231
	cURus Underwriters Laboratories Inc.	UL 1977	E45171

Declarations of conformity and manufacturer's declarations

Logo	Approval	Additional Approval Text	Certificate name
	EU-Declaration of Conformity WAGO GmbH & Co. KG	-	-
	UK-Declaration of Conformity WAGO GmbH & Co. KG	-	-

Approvals for marine applications

Logo	Approval	Additional Approval Text	Certificate name
	ABS American Bureau of Shipping	Steel Vessel Rules	19- HG1869855- PDA
	DNV GL Det Norske Veritas, Germanischer Lloyd	-	TAE00001Z6

Subject to changes. Please also observe the further product documentation!

WAGO GmbH & Co. KG
Hansastr. 27
32423 Minden
Phone: +49571 887-0 | Fax: +49571 887-169
Email: info.de@wago.com | Web: www.wago.com

Do you have any questions about our products?
We are always happy to take your call at +49 (571) 887-44222.

Counterpart



Item no.890-705/006-000

Snap-in socket; without locking lever; 5-pole; Cod. A; 1,50 mm²; black

www.wago.com/890-705/006-000

Downloads

Documentation

Bid Text

890-605 X81 - Datei	2019 Feb 19	xml 2.8 kB	Download
890-605 doc - Datei	2018 Nov 30	doc 23.6 kB	Download

CAD/CAE-Data

CAD data

2D/3D Models 890-605	URL	Download
----------------------	-----	----------

CAE data

WSCAD Universe 890-605	URL	Download
ZUKEN Portal 890-605	URL	Download

Asset Administration Shell

Asset Administration Shell 890-605	URL	Download
------------------------------------	-----	----------

Environmental Product Compliance

Compliance Search

Environmental Product Compliance 890-605 Intermediate coupler; 5-pole; Cod. A; for sockets and plugs; black	URL	Download
--	-----	----------

Installation Notes

Subject to changes. Please also observe the further product documentation!

WAGO GmbH & Co. KG
Hansastr. 27
32423 Minden
Phone: +49571 887-0 | Fax: +49571 887-169
Email: info.de@wago.com | Web: www.wago.com

Do you have any questions about our products?
We are always happy to take your call at +49 (571) 887-44222.

Installation

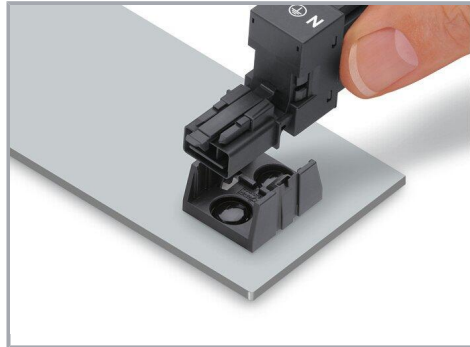

Secure the mounting plate via pins.

Product family

WINSTA® MINI

[Show all products from the family](#)

Subject to changes. Please also observe the further product documentation!