

Data sheet | Item number: 770-1102
Socket; 2-pole; Cod. I; 4,00 mm²; blue

www.wago.com/770-1102

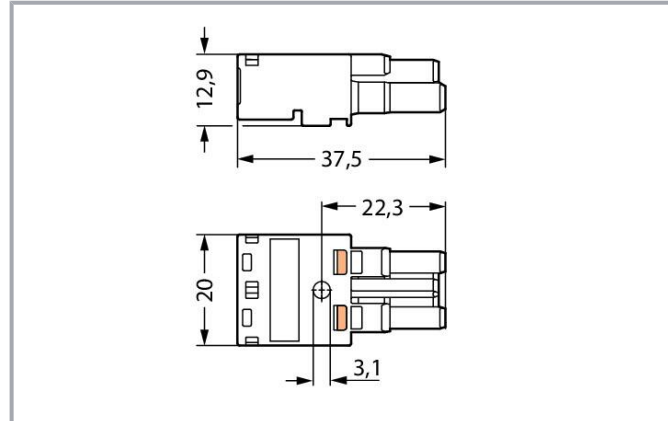

Item description

Female connector/socket *WINSTA*® MIDI with protection type IP20

For signal and power transmission: The *WINSTA*® MIDI female connector/socket I coding. WAGO pluggable installation connectors are useful when criteria repeat or are distributed on a specified grid, for example for installing grid lighting or flush-mount lighting. For greater security in electrical installations, the pluggable installation connector is provided with mechanical protection against mismatching. The pluggable installation connector is protected in accordance with protection type IP20 (When mated and secured with a strain relief housing: IP2xC (These compact connectors are not designed for use in open, easily accessible areas!)). This means that users' fingers will never come into contact with electrified contact elements. I coding in blue is used to identify *WINSTA*® MIDI pluggable installation connectors, which are used primarily in automation of buildings for activating lighting. This pluggable installation connector can be used for a voltage load of up to 25 A. Therefore, it can also be used for high power loads. *WINSTA*® MIDI with Push-in CAGE CLAMP® spring pressure connection technology is used in a broad range of individual products you can use for quick, easy, flexible, and secure installation.

WINSTA® MIDI solutions for your electrical installation – protected against mismatching and maintenance-free

The *WINSTA*® Pluggable Connection System is perfectly tailored to the very strict requirements of building installation. It makes electrical installation pluggable, and consequently faster, more reliable, and error-free. Using this pre-assembled system reduces time spent on assembly and errors during installation at the construction site. Now you can also lower installation costs without compromising safety and quality: with protection

Subject to changes. Please also observe the further product documentation!

WAGO GmbH & Co. KG
Hansastr. 27
32423 Minden
Phone: +49571 887-0 | Fax: +49571 887-169
Email: info.de@wago.com | Web: www.wago.com

Do you have any questions about our products?
We are always happy to take your call at +49 (571) 887-44222.

against mismatching reduces the need for servicing and prevents unnecessary downtime.

-
- pluggable installation connectors with protection against mismatching
- pre-assembled versions
- with I coding for use in building automation (lighting control)
- custom-engineered solutions
- convenient installation and commissioning

Data

Electrical data

Ratings per IEC/EN

Ratings per	IEC/EN 60664-1
Nominal voltage (III/3)	250 V
Rated impulse voltage (III/3)	4 kV
Rated current	25 A
Legend (ratings)	(III / 3) ≙ Overvoltage category III / Pollution degree 3

Ratings per UL 1977

Note for the US market	Some versions may also be used for current interruption in accordance with the UL certificate in select applications with currents below 16 A and voltages up to 600 V. For further information, please contact your local sales office.
Rated voltage (UL 1977)	600 V
Rated current UL 1977	23 A

General information

Note on contact resistance	approx. 1 mΩ of contact resistance approx. 0.25 mΩ contact transition plug/socket
----------------------------	--

Connection data

Connection points	4
Total number of potentials	2

Connection 1

Connection technology

Subject to changes. Please also observe the further product documentation!



	Push-in CAGE CLAMP®
Actuation type	Operating tool Push-in
Nominal cross-section	4 mm ² / 12 AWG
Solid conductor	0.5 ... 4 mm ² / 20 ... 12 AWG
Solid conductor; push-in termination	1.5 ... 4 mm ² / 16 ... 12 AWG
Stranded conductor	0.5 ... 2.5 mm ² / 20 ... 14 AWG
Fine-stranded conductor	0.5 ... 4 mm ² / 20 ... 12 AWG
Fine-stranded conductor; with insulated ferrule	0.25 ... 1.5 mm ² / 20 ... 16 AWG
Fine-stranded conductor; with uninsulated ferrule	0.25 ... 2.5 mm ² / 20 ... 14 AWG
Fine-stranded conductor; with ferrule; push-in termination	1.5 mm ² / 16 AWG
Strip length	9 mm / 0.35 inches
Pole number	2
Conductor entry direction to mating direction	0°

Physical data

Pin spacing	10 mm / 0.394 inches
Width	20 mm / 0.787 inches
Height	12.9 mm / 0.508 inches
Depth	37.5 mm / 1.476 inches

Mechanical Data

Application	DALI, Lighting Management
Coding	I
Variable coding	No
Marking	DA+ DA-
Potential marking	DA+ DA-
Mating force of a plug-in connection	approx. 20 ... 70 N (depending on pole number)
Retention force of a plug-in connection	Locked: > 80 N
Unmating force of a plug-in connection	Unlocked: approx. 20 ... 70 N (depending on pole number)
Number of mating cycles	200, without resistive load
Protection type	IP20; When mated and secured with a strain relief housing: IP2xC (These compact connectors are not designed for use in open, easily accessible areas!)

Plug-in connection

Contact type (pluggable connector)	Female connector/socket
------------------------------------	-------------------------

Subject to changes. Please also observe the further product documentation!



Connector (connection type)	for conductor
Mismating protection	Yes
Note on mismating protection	All <i>WINSTA</i> [®] components are 100% protected against mismating when: a.) plugging different numbers of poles b.) plugging while rotated 180 c.) plugging while laterally staggered d.) plugging one pole
Locking lever	Can be retrofitted
Locking of plug-in connection	locking lever
Note on locking system	All connectors for mounted installations (snap-in versions for lighting fixtures or devices, all types of PCB and distribution connectors) are factory-equipped with locking levers to ensure plugs and sockets are securely locked. Additional locking levers are only required for flying leads (plug/socket).

Material data

Note (material data)	Information on material specifications can be found here
Color	blue
Cover color	gray
Material group	I
Insulation material	Polyamide (PA66)
Flammability class per UL94	V0
Clamping spring material	Chrome-nickel spring steel (CrNi)
Contact material	Copper or copper alloy; surface-treated
Contact plating	Tin
Fire load	0.127 MJ
Weight	6.6 g

Environmental requirements

Processing temperature	-5 ... +40 °C
Continuous operating temperature	-35 ... +85 °C
Note on continuous operating temperature	Insulating parts for temperatures ≤ 105 °C

Commercial data

Product Group	20 (Winsta)
eCl@ss 10.0	27-44-06-05

Subject to changes. Please also observe the further product documentation!



eCl@ss 9.0	27-44-06-05
ETIM 8.0	EC002560
ETIM 7.0	EC002560
ECCN	NO DATA
PU (SPU)	100 pcs
Packaging type	box
Country of origin	DE
GTIN	4050821028154
Customs tariff number	85366990990

Environmental Product Compliance

RoHS Compliance Status	Compliant, No Exemption
------------------------	-------------------------

Approvals / Certificates

General approvals

Logo	Approval	Additional Approval Text	Certificate name
	CCA DEKRA Certification B.V.	EN 61535	71- 123228
	CCA DEKRA Certification B.V.	IEC 61535	NL -84761
	cURus Underwriters Laboratories Inc.	UL 1977	E45171
	cURus Underwriters Laboratories Inc.	UL 1059	E 45172
	VDE VDE Prüf- und Zertifizierungsinstitut	EN 61535	40029808

Declarations of conformity and manufacturer's declarations

Logo	Approval	Additional Approval Text	Certificate name
	EU-Declaration of Conformity WAGO GmbH & Co. KG	-	-



Subject to changes. Please also observe the further product documentation!

WAGO GmbH & Co. KG
 Hansastr. 27
 32423 Minden
 Phone: +49571 887-0 | Fax: +49571 887-169
 Email: info.de@wago.com | Web: www.wago.com





Do you have any questions about our products?
 We are always happy to take your call at +49 (571) 887-44222.



Approvals for marine applications



Logo	Approval	Additional Approval Text	Certificate name
	ABS American Bureau of Shipping	-	19- HG1868589- PDA
	DNV GL Det Norske Veritas, Germanischer Lloyd	-	TAE00001Z6
	LR Lloyds Register	IEC 61984	LR22429487TA

Counterpart

	Item no.770-7102 Linect® T-connector; 2-pole; Cod. I; 1 input; 2 outputs; white	www.wago.com/770-7102
	Item no.770-1112 Plug; 2-pole; Cod. I; 4,00 mm ² ; blue	www.wago.com/770-1112
	Item no.771-8982/006-101 pre-assembled interconnecting cable; Eca; Socket/plug; 2-pole; Cod. I; H05VV-F 2 x 1.5 mm ² ; 1 m; 1,50 mm ² ; blue	www.wago.com/771-8982/006-101
	Item no.771-8982/206-101 pre-assembled connecting cable; Eca; Plug/open-ended; 2-pole; Cod. I; H05VV-F 2 x 1.5 mm ² ; 1 m; 1,50 mm ² ; blue	www.wago.com/771-8982/206-101

Required accessories

Locking levers

Locking system		
	Item no.: 770-121 Locking lever; for flying leads; for manual operation; white	www.wago.com/770-121
	Item no.: 770-131 Locking lever; for flying leads; for tool operation; white	www.wago.com/770-131

Subject to changes. Please also observe the further product documentation!



Item no.: 770-101
Locking lever; for flying leads; for manual operation; black

www.wago.com/770-101



Item no.: 770-111
Locking lever; for flying leads; for tool operation; black

www.wago.com/770-111

Strain relief

Strain relief housing



Item no.: 770-502/041-000
Strain relief housing; 2-pole; with locking clip; for 1 cable; 7.0 ... 10.5 mm; 35 mm; black

www.wago.com/770-502/041-000



Item no.: 770-502/042-000
Strain relief housing; 2-pole; with locking clip; for 1 cable; 5.0 ... 9.0 mm; 35 mm; black

www.wago.com/770-502/042-000



Item no.: 770-512/041-000
Strain relief housing; 2-pole; with locking clip; for 1 cable; 7.0 ... 10.5 mm; 35 mm; white

www.wago.com/770-512/041-000



Item no.: 770-512/042-000
Strain relief housing; 2-pole; with locking clip; for 1 cable; 5.0 ... 9.0 mm; 35 mm; white

www.wago.com/770-512/042-000

Optional accessories

Tool

Operating tool



Item no.: 210-719
Operating tool; Blade: 2.5 x 0.4 mm; with a partially insulated shaft

www.wago.com/210-719



Item no.: 770-382
Operating tool; 2-way; green

www.wago.com/770-382

Cover

Cover



Item no.: 770-201
Lockout cap; 12-pole, separable; for sockets; Plastic; black

www.wago.com/770-201



Item no.: 770-221
Lockout cap; 12-pole, separable; for sockets; Plastic; white

www.wago.com/770-221

Subject to changes. Please also observe the further product documentation!



Item no.: 897-2003
Protective cap; Type2; for sockets and plugs; PVC; red

www.wago.com/897-2003

Mounting

Mounting accessories



Item no.: 770-317
Snap-in frame; 2-pole; 1.0 ... 3.0 mm; black

www.wago.com/770-317



Item no.: 770-337
Snap-in frame; 2-pole; 1.0 ... 3.0 mm; white

www.wago.com/770-337



Item no.: 897-2100
Mounting plate; for Snap-in; Plastic; for detectors and sensors ; Ø 200 mm; red

www.wago.com/897-2100

Downloads

Documentation

Bid Text

770-1102 X81 - Datei	2019 Feb 19	xml 3.0 kB	Download
770-1102 doc - Datei	2015 Jun 8	doc 24.1 kB	Download

CAD/CAE-Data

CAE data

EPLAN Data Portal 770-1102	URL	Download
WSCAD Universe 770-1102	URL	Download

Asset Administration Shell

Asset Administration Shell 770-1102	URL	Download
-------------------------------------	-----	----------

Environmental Product Compliance

Compliance Search

Subject to changes. Please also observe the further product documentation!

Installation Notes

Conductor termination

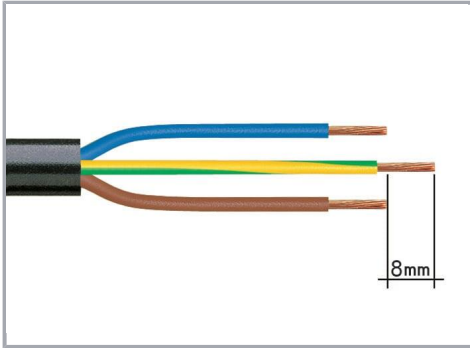

1. Strip length, outer insulation = 35 mm (2-pole), 55 mm (3- to 5-pole)
2. Strip length = 9 mm
3. Extended ground conductor = 8 mm

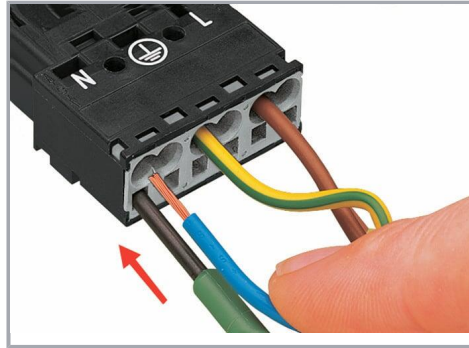

To terminate fine-stranded conductors, open the clamping unit via screwdriver (2.5 mm blade width) and insert a stripped conductor until it hits the backstop.

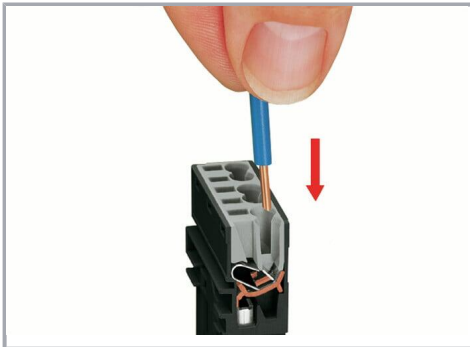

Insert the stripped solid conductor until it hits the backstop.

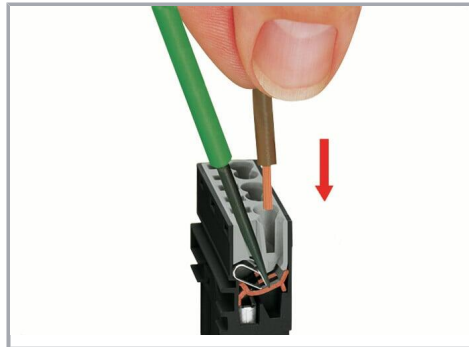

To terminate fine-stranded conductors, open the clamping unit via screwdriver (2.5 mm blade width) and insert a stripped conductor until it hits the backstop.

Conductor removal

Subject to changes. Please also observe the further product documentation!

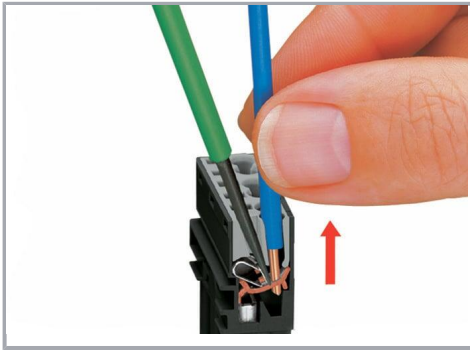

To remove the conductor, actuate the clamp via screwdriver (2.5 mm blade width) and pull out the conductor.

Installation

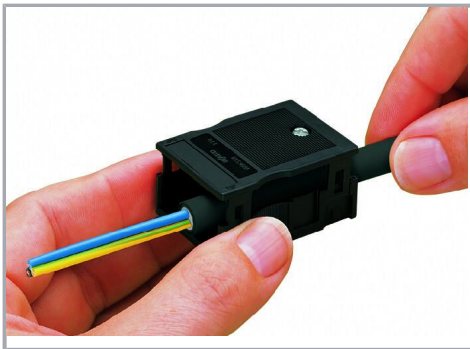

We recommend pulling the pre-latched strain relief housing over the cable prior to termination. However, the strain relief can be mounted at a later time as well.



Latch the strain relief housing onto the plug /socket. Note the "TOP" inscription.

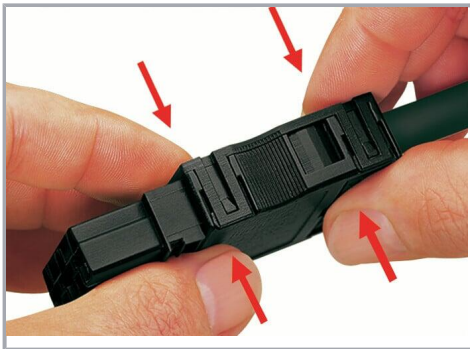

Prepare strain relief housing by snapping together upper and bottom part.



Tighten strain relief screw with screwdriver (2.5 mm blade width).

Product family

Subject to changes. Please also observe the further product documentation!



WINSTA® MIDI

[Show all products from the family](#)

Subject to changes. Please also observe the further product documentation!

WAGO GmbH & Co. KG
Hansastr. 27
32423 Minden
Phone: +49571 887-0 | Fax: +49571 887-169
Email: info.de@wago.com | Web: www.wago.com

Do you have any questions about our products?
We are always happy to take your call at +49 (571) 887-44222.