

## Item description

### Female connector/socket WINSTA® MIDI with protection type IP20

The WINSTA® MIDI female connector/socket with protection against mismatching supports rapid, correct installation. WAGO pluggable installation connectors are useful when requirements repeat or are distributed on a specific pattern, for example for installing grid lighting or flush-mount lighting. The coding options reduce installation errors, allowing fast, secure wiring of all components. The pluggable installation connector is protected against ingress by solid objects in accordance with protection type IP20 (When mated and secured with a strain relief housing: IP2xC (These compact connectors are not designed for use in open, easily accessible areas!)). Solutions like the WINSTA® MIDI pluggable installation connectors with B coding are appropriate for applications related to process control, for example, for lighting or in data networks. Important parameters in the selection of a pluggable installation connector are the rated current and voltage: They tell us about the product's domains of use. This product has a current rating of 25 A – as a result it is suitable for high power loads. The WINSTA® MIDI Pluggable Connection System with Push-in CAGE CLAMP® spring pressure connection technology facilitates precise electrification. Due to the included test slot, connections can be checked even when they are plugged in. That saves time and reduces installation labor and costs.

### WINSTA® MIDI solutions for your electrical installation – protected against mismatching and maintenance-free

The WINSTA® Pluggable Connection System is perfectly tailored to the strict requirements of building installation. It makes electrical installation pluggable, and thus faster, even more reliable, and error-free. Using this pre-assembled system decreases time spent on assembly and installation errors at the construction site. Now you can also cut installation expenses without compromising quality and safety: with protection type IP20

Subject to changes. Please also observe the further product documentation!



reduces the need for servicing and prevents unnecessary downtime.

- 
- protection against mismatching eliminates errors
- simple circuits
- with B coding for controllers such as lighting fixtures and sun blinds
- custom-engineered solutions
- convenient installation and commissioning

## Data

### Notes

Variants:

Other pole markings

Other versions (or variants) can be requested from WAGO Sales or configured at <https://configurator.wago.com/>.

## Electrical data

### Ratings per IEC/EN

Ratings per	IEC/EN 60664-1
Nominal voltage (III/3)	250 V
Rated impulse voltage (III/3)	4 kV
Rated current	25 A
Legend (ratings)	(III / 3) ≙ Overvoltage category III / Pollution degree 3

### Ratings per UL 1977

Note for the US market	Some versions may also be used for current interruption in accordance with the UL certificate in select applications with currents below 16 A and voltages up to 600 V. For further information, please contact your local sales office.
Rated voltage (UL 1977)	600 V
Rated current UL 1977	23 A

## General information

Note on contact resistance	approx. 1 mΩ of contact resistance approx. 0.25 mΩ contact transition plug/socket
----------------------------	--

Subject to changes. Please also observe the further product documentation!



## Connection data

Connection points	4
Total number of potentials	2

## Connection 1

Connection technology	Push-in CAGE CLAMP®
Actuation type	Operating tool Push-in
Nominal cross-section	4 mm <sup>2</sup> / 12 AWG
Solid conductor	0.5 ... 4 mm <sup>2</sup> / 20 ... 12 AWG
Solid conductor; push-in termination	1.5 ... 4 mm <sup>2</sup> / 16 ... 12 AWG
Stranded conductor	0.5 ... 2.5 mm <sup>2</sup> / 20 ... 14 AWG
Fine-stranded conductor	0.5 ... 4 mm <sup>2</sup> / 20 ... 12 AWG
Fine-stranded conductor; with insulated ferrule	0.25 ... 1.5 mm <sup>2</sup> / 20 ... 16 AWG
Fine-stranded conductor; with uninsulated ferrule	0.25 ... 2.5 mm <sup>2</sup> / 20 ... 14 AWG
Fine-stranded conductor; with ferrule; push-in termination	1.5 mm <sup>2</sup> / 16 AWG
Strip length	9 mm / 0.35 inches
Pole number	2
Conductor entry direction to mating direction	0°

## Physical data

Pin spacing	10 mm / 0.394 inches
Width	20 mm / 0.787 inches
Height	12.9 mm / 0.508 inches
Depth	37.5 mm / 1.476 inches

## Mechanical Data

Application	Control technology
Coding	B
Variable coding	No
Marking	1 2
Potential marking	1 2
Mating force of a plug-in connection	approx. 20 ... 70 N (depending on pole number)
Retention force of a plug-in connection	Locked: > 80 N
Unmating force of a plug-in connection	Unlocked: approx. 20 ... 70 N (depending on pole number)

Subject to changes. Please also observe the further product documentation!



Number of mating cycles	200, without resistive load
Protection type	IP20; When mated and secured with a strain relief housing: IP2xC (These compact connectors are not designed for use in open, easily accessible areas!)

### Plug-in connection

Contact type (pluggable connector)	Female connector/socket
Connector (connection type)	for conductor
Mismating protection	Yes
Note on mismating protection	All <i>WINSTA</i> <sup>®</sup> components are 100% protected against mismating when: a.) plugging different numbers of poles b.) plugging while rotated 180 c.) plugging while laterally staggered d.) plugging one pole
Locking lever	Can be retrofitted
Locking of plug-in connection	locking lever
Note on locking system	All connectors for mounted installations (snap-in versions for lighting fixtures or devices, all types of PCB and distribution connectors) are factory-equipped with locking levers to ensure plugs and sockets are securely locked. Additional locking levers are only required for flying leads (plug/socket).

### Material data

Note (material data)	Information on material specifications can be found here
Color	light green
Cover color	gray
Material group	I
Insulation material	Polyamide (PA66)
Flammability class per UL94	V0
Clamping spring material	Chrome-nickel spring steel (CrNi)
Contact material	Copper or copper alloy; surface-treated
Contact plating	Tin
Fire load	0.127 MJ
Weight	6.6 g

Subject to changes. Please also observe the further product documentation!

## Environmental requirements

Processing temperature	-5 ... +40 °C
Continuous operating temperature	-35 ... +85 °C
Note on continuous operating temperature	Insulating parts for temperatures ≤ 105 °C

## Commercial data



Product Group	20 (Winsta)
eCl@ss 10.0	27-44-06-05
eCl@ss 9.0	27-44-06-05
ETIM 8.0	EC002560
ETIM 7.0	EC002560
ECCN	NO DATA
PU (SPU)	100 pcs
Packaging type	box
Country of origin	DE
GTIN	4050821541882
Customs tariff number	85366990990

## Environmental Product Compliance

RoHS Compliance Status	Compliant, No Exemption
------------------------	-------------------------

## Approvals / Certificates



### General approvals

Logo	Approval	Additional Approval Text	Certificate name
	CCA DEKRA Certification B.V.	IEC 61984	NL-32104
	CCA DEKRA Certification B.V.	EN 61984	2173495.01
	cURus Underwriters Laboratories Inc.	UL 1977	E45171
	cURus Underwriters Laboratories Inc.	UL 1059	E 45172



Subject to changes. Please also observe the further product documentation!





## Declarations of conformity and manufacturer's declarations

Logo	Approval	Additional Approval Text	Certificate name
	EU-Declaration of Conformity WAGO GmbH & Co. KG	-	-
	UK-Declaration of Conformity WAGO GmbH & Co. KG	-	-

## Approvals for marine applications

Logo	Approval	Additional Approval Text	Certificate name
	ABS American Bureau of Shipping	-	19- HG1868589- PDA
	DNV GL Det Norske Veritas, Germanischer Lloyd	-	TAE00001Z6
	LR Lloyds Register	IEC 61984	LR22429487TA





## Counterpart

	Item no.770-1602 T-distribution connector; 2-pole; Cod. B; 1 input; 2 outputs; 2 locking levers; light green	<a href="http://www.wago.com/770-1602">www.wago.com/770-1602</a>
	Item no.770-1609 h-distribution connector; 2-pole; Cod. B; 1 input; 2 outputs; outputs on both sides; 2 locking levers; light green	<a href="http://www.wago.com/770-1609">www.wago.com/770-1609</a>
	Item no.770-1652	

Subject to changes. Please also observe the further product documentation!

WAGO GmbH & Co. KG  
Hansastr. 27  
32423 Minden  
Phone: +49571 887-0 | Fax: +49571 887-169  
Email: [info.de@wago.com](mailto:info.de@wago.com) | Web: [www.wago.com](http://www.wago.com)





Do you have any questions about our products?  
We are always happy to take your call at +49 (571) 887-44222.

	h-distribution connector; 2-pole; Cod. B; 1 input; 2 outputs; outputs on one side; 2 locking levers; light green	<a href="http://www.wago.com/770-1652">www.wago.com/770-1652</a>
	<b>Item no.770-1659</b> h-distribution connector; 2-pole; Cod. B; 1 input; 2 outputs; outputs on both sides; 3 locking levers; for flying leads; light green	<a href="http://www.wago.com/770-1659">www.wago.com/770-1659</a>
	<b>Item no.770-1702</b> T-distribution connector; 2-pole; Cod. B; 1 input; 2 outputs; 3 locking levers; for flying leads; light green	<a href="http://www.wago.com/770-1702">www.wago.com/770-1702</a>
	<b>Item no.770-1705</b> 3-way distribution connector; 2-pole; Cod. B; 1 input; 3 outputs; light green	<a href="http://www.wago.com/770-1705">www.wago.com/770-1705</a>
	<b>Item no.770-272</b> Plug; 2-pole; Cod. B; 4,00 mm <sup>2</sup> ; light green	<a href="http://www.wago.com/770-272">www.wago.com/770-272</a>
	<b>Item no.770-1752</b> h-distribution connector; 2-pole; Cod. B; 1 input; 2 outputs; outputs on one side; 3 locking levers; for flying leads; light green	<a href="http://www.wago.com/770-1752">www.wago.com/770-1752</a>
	<b>Item no.771-8992/005-105</b> pre-assembled interconnecting cable; Eca; Socket/plug; 2-pole; Cod. B; Control cable 2 x 1.0 mm <sup>2</sup> ; 1 m; 1,00 mm <sup>2</sup> ; light green	<a href="http://www.wago.com/771-8992/005-105">www.wago.com/771-8992/005-105</a>
	<b>Item no.771-8992/205-105</b> pre-assembled connecting cable; Eca; Plug/open-ended; 2-pole; Cod. B; Control cable 2 x 1.0 mm <sup>2</sup> ; 1 m; 1,00 mm <sup>2</sup> ; light green	<a href="http://www.wago.com/771-8992/205-105">www.wago.com/771-8992/205-105</a>

## Required accessories

### Locking levers

#### Locking system

	<b>Item no.: 770-121</b> Locking lever; for flying leads; for manual operation; white	<a href="http://www.wago.com/770-121">www.wago.com/770-121</a>
	<b>Item no.: 770-131</b> Locking lever; for flying leads; for tool operation; white	<a href="http://www.wago.com/770-131">www.wago.com/770-131</a>
	<b>Item no.: 770-101</b> Locking lever; for flying leads; for manual operation; black	<a href="http://www.wago.com/770-101">www.wago.com/770-101</a>
	<b>Item no.: 770-111</b> Locking lever; for flying leads; for tool operation; black	<a href="http://www.wago.com/770-111">www.wago.com/770-111</a>

### Strain relief

#### Strain relief housing

Subject to changes. Please also observe the further product documentation!



Item no.: 770-502/041-000

Strain relief housing; 2-pole; with locking clip; for 1 cable; 7.0 ... 10.5 mm; 35 mm; black

[www.wago.com/770-502/041-000](http://www.wago.com/770-502/041-000)



Item no.: 770-502/042-000

Strain relief housing; 2-pole; with locking clip; for 1 cable; 5.0 ... 9.0 mm; 35 mm; black

[www.wago.com/770-502/042-000](http://www.wago.com/770-502/042-000)



Item no.: 770-512/041-000

Strain relief housing; 2-pole; with locking clip; for 1 cable; 7.0 ... 10.5 mm; 35 mm; white

[www.wago.com/770-512/041-000](http://www.wago.com/770-512/041-000)



Item no.: 770-512/042-000

Strain relief housing; 2-pole; with locking clip; for 1 cable; 5.0 ... 9.0 mm; 35 mm; white

[www.wago.com/770-512/042-000](http://www.wago.com/770-512/042-000)

## Optional accessories

### Cover

#### Cover



Item no.: 770-201

Lockout cap; 12-pole, separable; for sockets; Plastic; black

[www.wago.com/770-201](http://www.wago.com/770-201)



Item no.: 770-221

Lockout cap; 12-pole, separable; for sockets; Plastic; white

[www.wago.com/770-221](http://www.wago.com/770-221)



Item no.: 897-2003

Protective cap; Type2; for sockets and plugs; PVC; red

[www.wago.com/897-2003](http://www.wago.com/897-2003)

### Tool

#### Operating tool



Item no.: 210-719

Operating tool; Blade: 2.5 x 0.4 mm; with a partially insulated shaft

[www.wago.com/210-719](http://www.wago.com/210-719)



Item no.: 770-382

Operating tool; 2-way; green

[www.wago.com/770-382](http://www.wago.com/770-382)

### Mounting

#### Mounting accessories



Item no.: 770-317

Snap-in frame; 2-pole; 1.0 ... 3.0 mm; black

[www.wago.com/770-317](http://www.wago.com/770-317)

Subject to changes. Please also observe the further product documentation!

WAGO GmbH & Co. KG

Hansastr. 27

32423 Minden

Phone: +49571 887-0 | Fax: +49571 887-169

Email: [info.de@wago.com](mailto:info.de@wago.com) | Web: [www.wago.com](http://www.wago.com)

Do you have any questions about our products?

We are always happy to take your call at +49 (571) 887-44222.





**Item no.: 770-337**

Snap-in frame; 2-pole; 1.0 ... 3.0 mm; white

[www.wago.com/770-337](http://www.wago.com/770-337)

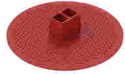

**Item no.: 897-2100**

Mounting plate; for Snap-in; Plastic; for detectors and sensors ; Ø 200 mm; red

[www.wago.com/897-2100](http://www.wago.com/897-2100)

## Downloads

### Documentation

#### Bid Text

770-262 X81 - Datei	2019 Feb 19	xml 3.0 kB	Download
770-262 doc - Datei	2015 Jun 8	doc 24.6 kB	Download

### CAD/CAE-Data

#### CAE data

EPLAN Data Portal 770-262	URL	Download
ZUKEN Portal 770-262	URL	Download
WSCAD Universe 770-262	URL	Download

#### CAD data

2D/3D Models 770-262	URL	Download
----------------------	-----	----------

#### Asset Administration Shell

Asset Administration Shell 770-262	URL	Download
------------------------------------	-----	----------

### Environmental Product Compliance

#### Compliance Search

Environmental Product Compliance 770-262 Socket; 2-pole; Cod. B; 4,00 mm <sup>2</sup> ; light green	URL	Download
--	-----	----------

Subject to changes. Please also observe the further product documentation!

## Installation Notes

### Conductor termination

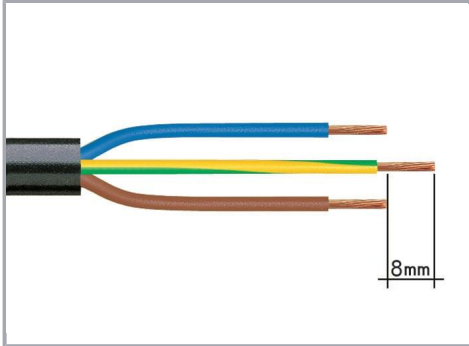

1. Strip length, outer insulation = 35 mm (2-pole), 55 mm (3- to 5-pole)
2. Strip length = 9 mm
3. Extended ground conductor = 8 mm

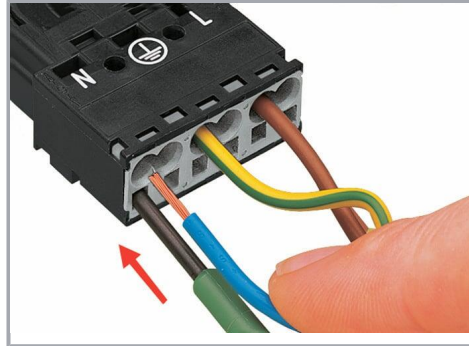

To terminate fine-stranded conductors, open the clamping unit via screwdriver (2.5 mm blade width) and insert a stripped conductor until it hits the backstop.

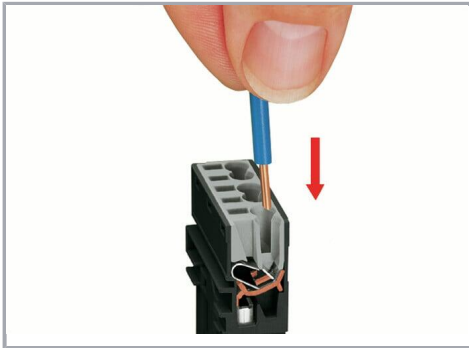

Insert the stripped solid conductor until it hits the backstop.

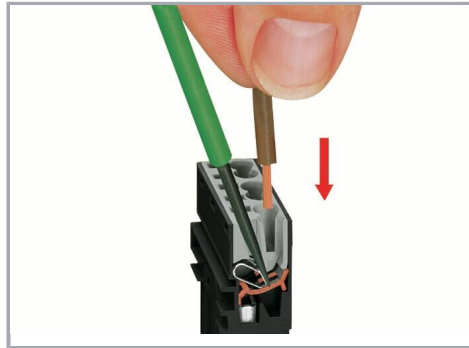

To terminate fine-stranded conductors, open the clamping unit via screwdriver (2.5 mm blade width) and insert a stripped conductor until it hits the backstop.

### Conductor removal

Subject to changes. Please also observe the further product documentation!

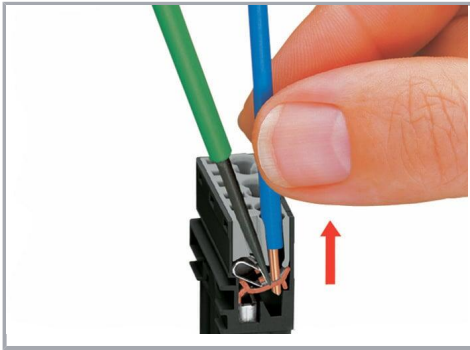

To remove the conductor, actuate the clamp via screwdriver (2.5 mm blade width) and pull out the conductor.

### Installation

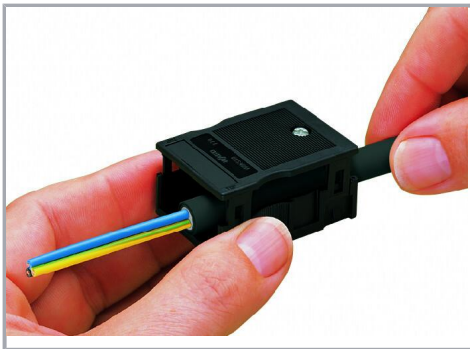

We recommend pulling the pre-latched strain relief housing over the cable prior to termination. However, the strain relief can be mounted at a later time as well.

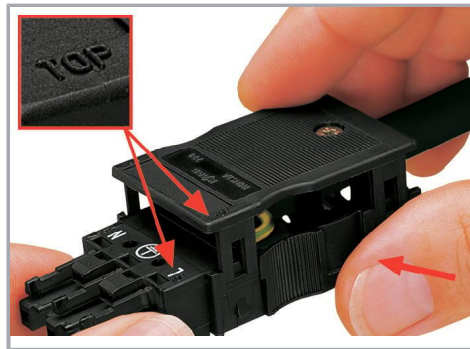

Latch the strain relief housing onto the plug /socket. Note the "TOP" inscription.

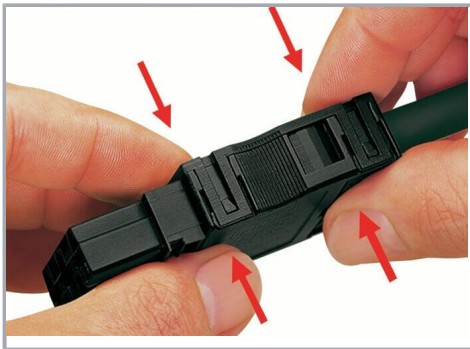

Prepare strain relief housing by snapping together upper and bottom part.



Tighten strain relief screw with screwdriver (2.5 mm blade width).

### Coding

Subject to changes. Please also observe the further product documentation!



Simply cut off the coding pin from the socket.

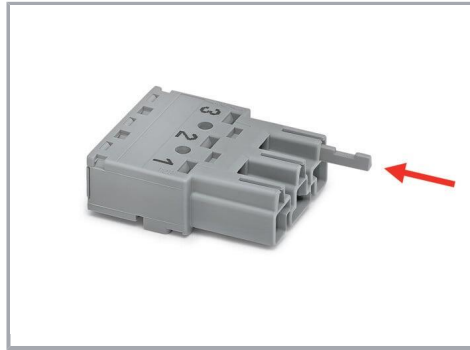

Insert coding pin into plug (break first) until it engages.

### Mismatching protection

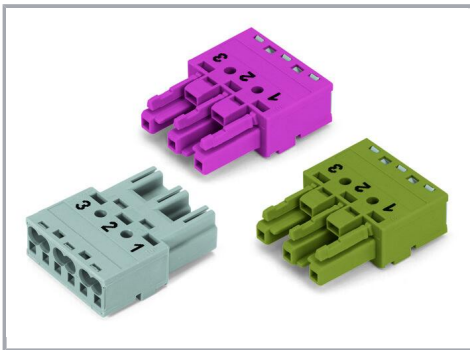

B-coded connectors with different colors can be plugged together.

#### Important note:

Different colors and/or pole markings are used for circuit identification.

Only connectors of the same color and same pole marking must be plugged together.

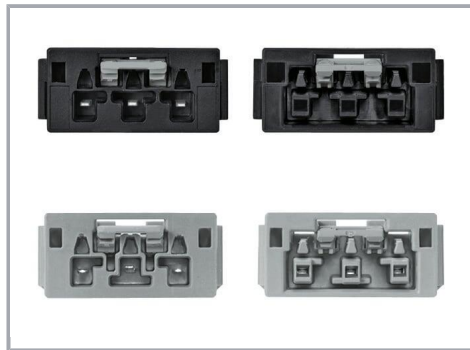

B-coded connectors (shown in gray) not only differ in color, but also in their design, making them incompatible with other coded connectors.

Subject to changes. Please also observe the further product documentation!



Easy circuit identification via different marking and colors

## Product family

**WINSTA® MIDI**

[Show all products from the family](#)

Subject to changes. Please also observe the further product documentation!