

Data sheet | Item number: 770-113

Plug; with strain relief housing; 3-pole; Cod. A; 4,00 mm²; black

www.wago.com/770-113

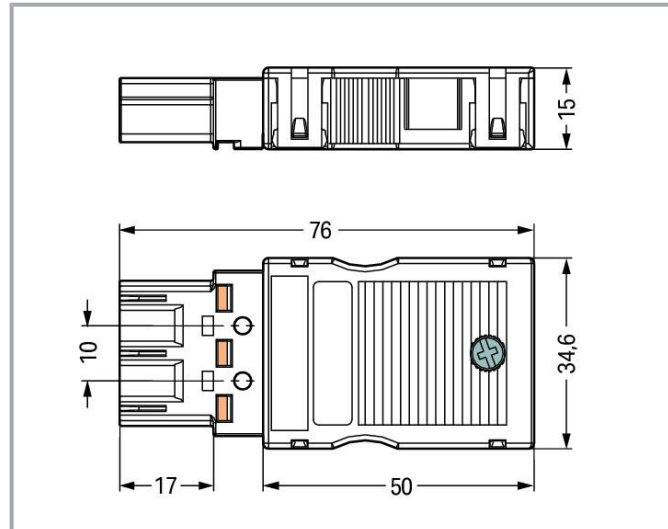
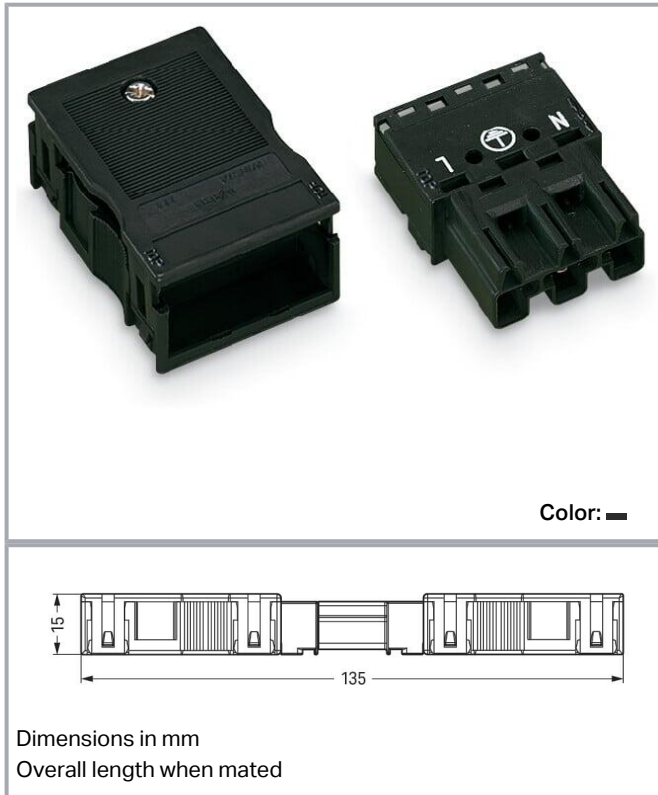

Item description

Male connector/plug *WINSTA*[®] MIDI with protection type IP20

For signal and power transmission: The *WINSTA*[®] MIDI male connector/plug with protection against mismatching. The pluggable installation connectors with spring pressure connection technology work completely without screw connections. They allow flexible, error-free installation in a large number of possible uses. The mechanical coding and color coding of the pluggable installation connector ensure error-free installation of the individual components – including protection against mismatching. The pluggable installation connector offers touch-proof protection with live components in accordance with protection type IP20 (When mated and secured with a strain relief housing: IP2xC (These compact connectors are not designed for use in open, easily accessible areas!)). The *WINSTA*[®] MIDI pluggable installation connector with A coding in white or black is usually used for general mains applications in power distribution. This pluggable installation connector can be used for a current load of up to 25 A. Thus, it can also be used for high power loads. *WINSTA*[®] MIDI with Push-in CAGE CLAMP[®] spring pressure connection technology is used in a broad range of individual products you can use for quick, easy, flexible, and secure electrical installation. The strip length is 55 mm.

Subject to changes. Please also observe the further product documentation!

WAGO GmbH & Co. KG
Hansastr. 27
32423 Minden
Phone: +49571 887-0 | Fax: +49571 887-169
Email: info.de@wago.com | Web: www.wago.com

Do you have any questions about our products?
We are always happy to take your call at +49 (571) 887-44222.



Push-in CAGE CLAMP® spring pressure connection technology – pluggable installation instead of laborious screw connections!

The WINSTA® Pluggable Connection System is perfectly tailored to the very strict requirements of building installation. It makes electrical installation pluggable, and thus faster, even more reliable, and error-free. Use of this pre-assembled system reduces assembly times and installation errors at the construction site. Enjoy the benefits of the pluggable version of our maintenance-free spring pressure connection technology too! Plan your installation with with marking from WAGO.

- protection against mismatching eliminates errors
- pre-assembled versions
- with A coding for use in many general mains applications
- ready to install and use immediately
- quick replacement of defective units during ongoing operation

Data

Electrical data

Ratings per IEC/EN

Ratings per	IEC/EN 60664-1
Nominal voltage (III/3)	250 V
Rated impulse voltage (III/3)	4 kV
Rated current	25 A
Legend (ratings)	(III / 3) ≙ Overvoltage category III / Pollution degree 3

Ratings per UL 1977

Note for the US market	Some versions may also be used for current interruption in accordance with the UL certificate in select applications with currents below 16 A and voltages up to 600 V. For further information, please contact your local sales office.
Rated voltage (UL 1977)	600 V
Rated current UL 1977	23 A

General information

Note on contact resistance	approx. 1 mΩ of contact resistance approx. 0.25 mΩ contact transition plug/socket
----------------------------	--

Subject to changes. Please also observe the further product documentation!



Connection data

Connection points	6
Total number of potentials	3
PE function	Preceding PE contact

Connection 1

Connection technology	Push-in CAGE CLAMP®
Actuation type	Operating tool Push-in
Nominal cross-section	4 mm ² / 12 AWG
Solid conductor	0.5 ... 4 mm ² / 20 ... 12 AWG
Solid conductor; push-in termination	1.5 ... 4 mm ² / 16 ... 12 AWG
Stranded conductor	0.5 ... 2.5 mm ² / 20 ... 14 AWG
Fine-stranded conductor	0.5 ... 4 mm ² / 20 ... 12 AWG
Fine-stranded conductor; with insulated ferrule	0.25 ... 1.5 mm ² / 20 ... 16 AWG
Fine-stranded conductor; with uninsulated ferrule	0.25 ... 2.5 mm ² / 20 ... 14 AWG
Fine-stranded conductor; with ferrule; push-in termination	1.5 mm ² / 16 AWG
Strip length	9 mm / 0.35 inches
Pole number	3
Conductor entry direction to mating direction	0°
Strip length (outer insulation)	55 mm

Physical data

Pin spacing	10 mm / 0.394 inches
Width	34.6 mm / 1.362 inches
Height	15 mm / 0.591 inches
Depth	76 mm / 2.992 inches

Mechanical Data

Application	General mains applications
Coding	A
Variable coding	Yes
Marking	N $\frac{1}{3}$ L
Potential marking	N $\frac{1}{3}$ L
Mating force of a plug-in connection	approx. 20 ... 70 N (depending on pole number)
Retention force of a plug-in connection	Locked: > 80 N

Subject to changes. Please also observe the further product documentation!



Unmating force of a plug-in connection	Unlocked: approx. 20 ... 70 N (depending on pole number)
Number of mating cycles	200, without resistive load
Protection type	IP20; When mated and secured with a strain relief housing: IP2xC (These compact connectors are not designed for use in open, easily accessible areas!)

Plug-in connection

Contact type (pluggable connector)	Male connector/plug
Connector (connection type)	for conductor
Mismating protection	Yes
Note on mismating protection	All <i>WINSTA</i> [®] components are 100% protected against mismating when: a.) plugging different numbers of poles b.) plugging while rotated 180 c.) plugging while laterally staggered d.) plugging one pole
Locking lever	Can be retrofitted
Locking of plug-in connection	locking lever
Note on locking system	All connectors for mounted installations (snap-in versions for lighting fixtures or devices, all types of PCB and distribution connectors) are factory-equipped with locking levers to ensure plugs and sockets are securely locked. Additional locking levers are only required for flying leads (plug/socket).
Strain relief	strain relief housing

Material data

Note (material data)	Information on material specifications can be found here
Color	black
Cover color	gray
Material group	I
Insulation material	Polyamide (PA66)
Flammability class per UL94	V0
Clamping spring material	Chrome-nickel spring steel (CrNi)
Contact material	Copper or copper alloy; surface-treated
Contact plating	Tin
Fire load	0.488 MJ
Strain relief color	black
Weight	20 g

Subject to changes. Please also observe the further product documentation!

Environmental requirements

Processing temperature	-5 ... +40 °C
Continuous operating temperature	-35 ... +85 °C
Note on continuous operating temperature	Insulating parts for temperatures ≤ 105 °C

Commercial data

Product Group	20 (Winsta)
eCl@ss 10.0	27-44-06-05
eCl@ss 9.0	27-44-06-05
ETIM 8.0	EC002560
ETIM 7.0	EC002560
ECCN	NO DATA
PU (SPU)	25 pcs
Packaging type	box
Country of origin	DE
GTIN	4044918254083
Customs tariff number	85366990990

Environmental Product Compliance

RoHS Compliance Status	Compliant, No Exemption
------------------------	-------------------------



Approvals / Certificates

General approvals

Logo	Approval	Additional Approval Text	Certificate name
	CCA DEKRA Certification B.V.	EN 61535	71- 123228
	CCA DEKRA Certification B.V.	IEC 61535	NL -84761
	cURus Underwriters Laboratories Inc.	UL 1977	E45171
	cURus Underwriters Laboratories Inc.	UL 1059	E 45172

Subject to changes. Please also observe the further product documentation!





	VDE VDE Prüf- und Zertifizierungsinstitut	EN 61535	40029808
	VDE VDE Prüf- und Zertifizierungsinstitut	EN 61984	40002889



Declarations of conformity and manufacturer's declarations

Logo	Approval	Additional Approval Text	Certificate name
	EU-Declaration of Conformity WAGO GmbH & Co. KG	-	-















Approvals for marine applications

Logo	Approval	Additional Approval Text	Certificate name
	ABS American Bureau of Shipping	-	19- HG1868589- PDA
	DNV GL Det Norske Veritas, Germanischer Lloyd	-	TAE00001Z6
	LR Lloyds Register	IEC 61984	LR22429487TA



Counterpart

	Item no.770-103 Socket; with strain relief housing; 3-pole; Cod. A; 4,00 mm ² ; black	www.wago.com/770-103
	Item no.770-203 Socket; 3-pole; Cod. A; 4,00 mm ² ; black	www.wago.com/770-203

Subject to changes. Please also observe the further product documentation!

	Item no.770-203/035-000 Socket; with strain relief housing; 3-pole; Cod. A; 4,00 mm ² ; black	www.wago.com/770-203/035-000
	Item no.770-606 T-distribution connector; 3-pole; Cod. A; 1 input; 2 outputs; 2 locking levers; black	www.wago.com/770-606
	Item no.770-608 5-way distribution connector; 3-pole; Cod. A; 1 input; 5 outputs; outputs on both sides; black	www.wago.com/770-608
	Item no.770-607 3-way distribution connector; 3-pole; Cod. A; 1 input; 3 outputs; black	www.wago.com/770-607
	Item no.770-611 Three-phase to single-phase distribution connector; with phase selection; 5-pole/3-pole; Cod. A; 1 input; 2 outputs; with cable connection on the input side; black	www.wago.com/770-611
	Item no.770-615 T-distribution connector; 3-pole; Cod. A; 1 input; 2 outputs; 3 locking levers; for flying leads; black	www.wago.com/770-615
	Item no.770-634 h-distribution connector; 3-pole; Cod. A; 1 input; 2 outputs; outputs on one side; 2 locking levers; black	www.wago.com/770-634
	Item no.770-633 h-distribution connector; 3-pole; Cod. A; 1 input; 2 outputs; 2 locking levers; black	www.wago.com/770-633
	Item no.770-635 h-distribution connector; 3-pole; Cod. A; 1 input; 2 outputs; outputs on both sides; 3 locking levers; for flying leads; black	www.wago.com/770-635
	Item no.770-636 h-distribution connector; 3-pole; Cod. A; 1 input; 2 outputs; outputs on one side; 3 locking levers; for flying leads; black	www.wago.com/770-636
	Item no.770-637 Distribution connector for switches; Single-pole switch and series circuit; 3-pole; Cod. A/S; 1 input; 5 outputs; black	www.wago.com/770-637
	Item no.770-638 Distribution connector for switches; Single-pole and throttle two-way circuit; 3-pole; Cod. A/S; 1 input; 5 outputs; black	www.wago.com/770-638
	Item no.770-640 Three-phase to single-phase distribution connector; with phase selection; 5-pole/3-pole; Cod. A; 1 input; 5 outputs; black	www.wago.com/770-640
	Item no.770-703 Snap-in socket; 3-pole; Cod. A; 4,00 mm ² ; black	www.wago.com/770-703
	Item no.770-703/009-000 Snap-in socket; with protruding mating face; 3-pole; Cod. A; 4,00 mm ² ; black	www.wago.com/770-703/009-000





Subject to changes. Please also observe the further product documentation!

	Item no. 770-803 Socket for PCBs; straight; 3-pole; Cod. A; black	www.wago.com/770-803
	Item no. 770-803/011-000 Socket for PCBs; angled; 3-pole; Cod. A; black	www.wago.com/770-803/011-000
	Item no. 771-9993/006-101 pre-assembled interconnecting cable; Eca; Socket/plug; 3-pole; Cod. A; H05VV-F 3G 1.5 mm ² ; 1 m; 1,50 mm ² ; black	www.wago.com/771-9993/006-101

Required accessories

Locking levers



Locking system

	Item no.: 770-121 Locking lever; for flying leads; for manual operation; white	www.wago.com/770-121
	Item no.: 770-131 Locking lever; for flying leads; for tool operation; white	www.wago.com/770-131
	Item no.: 770-101 Locking lever; for flying leads; for manual operation; black	www.wago.com/770-101
	Item no.: 770-111 Locking lever; for flying leads; for tool operation; black	www.wago.com/770-111

Optional accessories

Tool

Operating tool

	Item no.: 210-719 Operating tool; Blade: 2.5 x 0.4 mm; with a partially insulated shaft	www.wago.com/210-719
	Item no.: 770-383 Operating tool; 3-way; green	www.wago.com/770-383

Cover

Cover

	Item no.: 770-360 Lockout cap; for plugs; 5-pole; separable; yellow	www.wago.com/770-360
--	---	--

Coding

Coding

Subject to changes. Please also observe the further product documentation!



Item no.: 770-401
Coding pin; for plugs; Plastic; gray

www.wago.com/770-401

Marking accessories

Marker



Item no.: 770-450/000-002
Marker card; Plastic; yellow

www.wago.com/770-450/000-002



Item no.: 770-450/000-001
Marker card; Plastic; green

www.wago.com/770-450/000-001



Item no.: 770-450/000-005
Marker card; Plastic; red

www.wago.com/770-450/000-005



Item no.: 770-450
Marker card; Plastic; white

www.wago.com/770-450



Item no.: 770-450/000-006
Marker card; Plastic; blue

www.wago.com/770-450/000-006



Item no.: 770-450/000-012
Marker card; Plastic; orange

www.wago.com/770-450/000-012

Downloads

Documentation

Bid Text

770-113 X81 - Datei	2019 Feb 19	xml 3.1 kB	Download
770-113 doc - Datei	2015 Jun 8	doc 24.1 kB	Download
ausschreiben.de 770-113		URL	Download

CAD/CAE-Data

CAD data

2D/3D Models 770-113	URL	Download
----------------------	-----	----------

Subject to changes. Please also observe the further product documentation!

WAGO GmbH & Co. KG
Hansastr. 27
32423 Minden
Phone: +49571 887-0 | Fax: +49571 887-169
Email: info.de@wago.com | Web: www.wago.com

Do you have any questions about our products?
We are always happy to take your call at +49 (571) 887-44222.

CAE data

WSCAD Universe 770-113	URL	Download
ZUKEN Portal 770-113	URL	Download
EPLAN Data Portal 770-113	URL	Download

Asset Administration Shell

Asset Administration Shell 770-113	URL	Download
------------------------------------	---------------------	--------------------------

Environmental Product Compliance

Compliance Search

Environmental Product Compliance 770-113 Plug; with strain relief housing; 3-pole; Cod. A; 4,00 mm ² ; black	URL	Download
--	---------------------	--------------------------

Installation Notes

Conductor termination

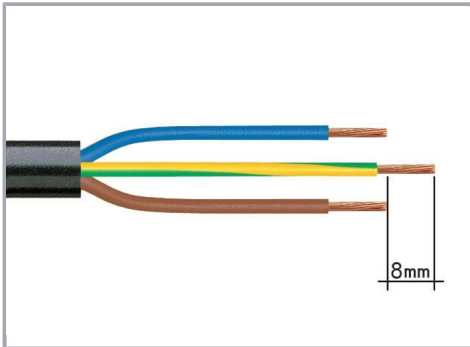

1. Strip length, outer insulation = 35 mm (2-pole), 55 mm (3- to 5-pole)
2. Strip length = 9 mm
3. Extended ground conductor = 8 mm

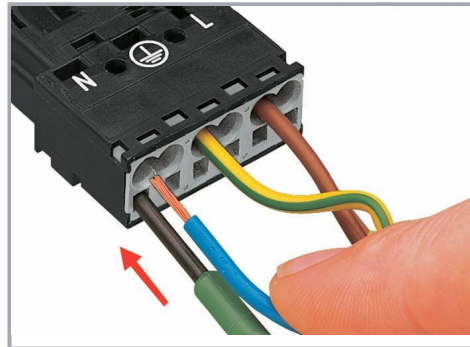

To terminate fine-stranded conductors, open the clamping unit via screwdriver (2.5 mm blade width) and insert a stripped conductor until it hits the backstop.

Subject to changes. Please also observe the further product documentation!

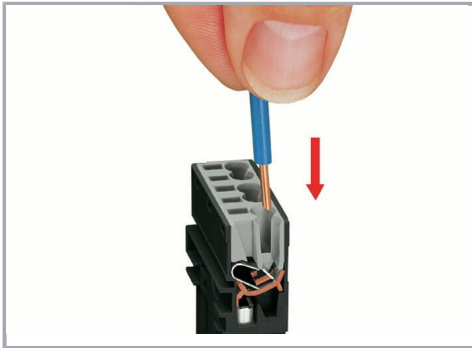

Insert the stripped solid conductor until it hits the backstop.

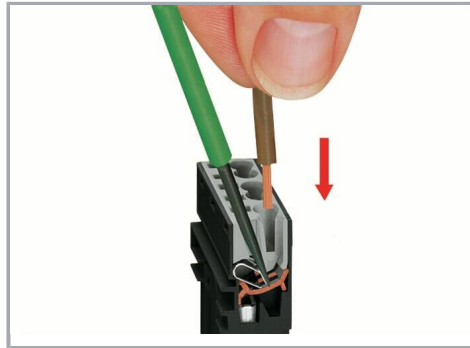

To terminate fine-stranded conductors, open the clamping unit via screwdriver (2.5 mm blade width) and insert a stripped conductor until it hits the backstop.

Conductor removal

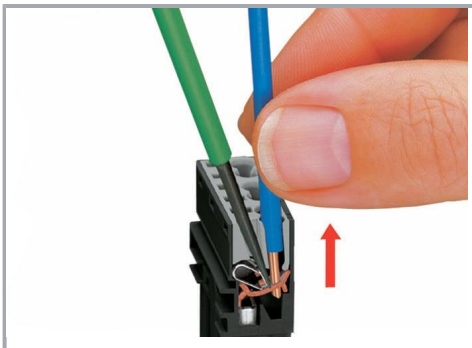

To remove the conductor, actuate the clamp via screwdriver (2.5 mm blade width) and pull out the conductor.

Coding



Simply cut off the coding pin from the socket.

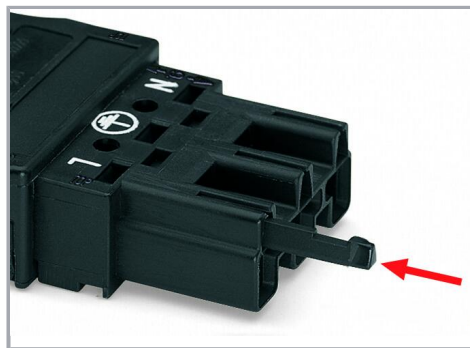

Insert coding pin into plug (break first) until it engages.

Shield termination

Subject to changes. Please also observe the further product documentation!

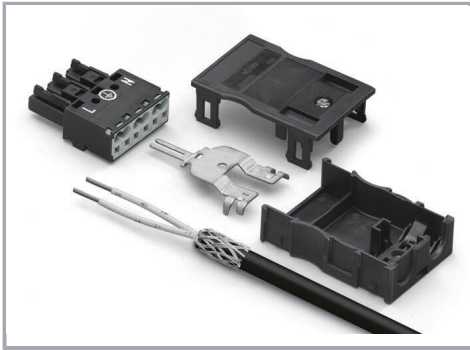

Connector with shield termination

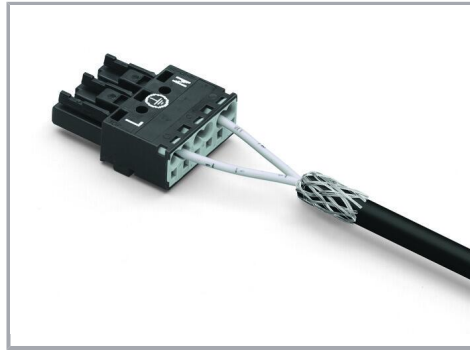

Apply the shield to the sheathed cable.

Strip length, outer insulation = 55 mm

Shield length = 10 mm

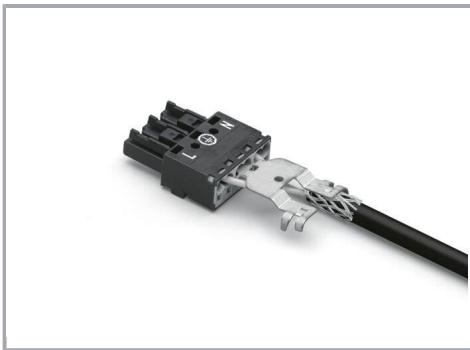

Push the shield connecting plate into the connector until fully inserted.



First insert the wired connector into a strain relief housing, then snap cover and tighten screw.

Product family

WINSTA® MIDI

[Show all products from the family](#)

Subject to changes. Please also observe the further product documentation!