

Data sheet | Item number: 2022-182

End module for 1-conductor female connector; Push-in CAGE CLAMP®; 4 mm²; Pin spacing 5.2 mm; 1-pole; 4,00 mm²; orange

www.wago.com/2022-182

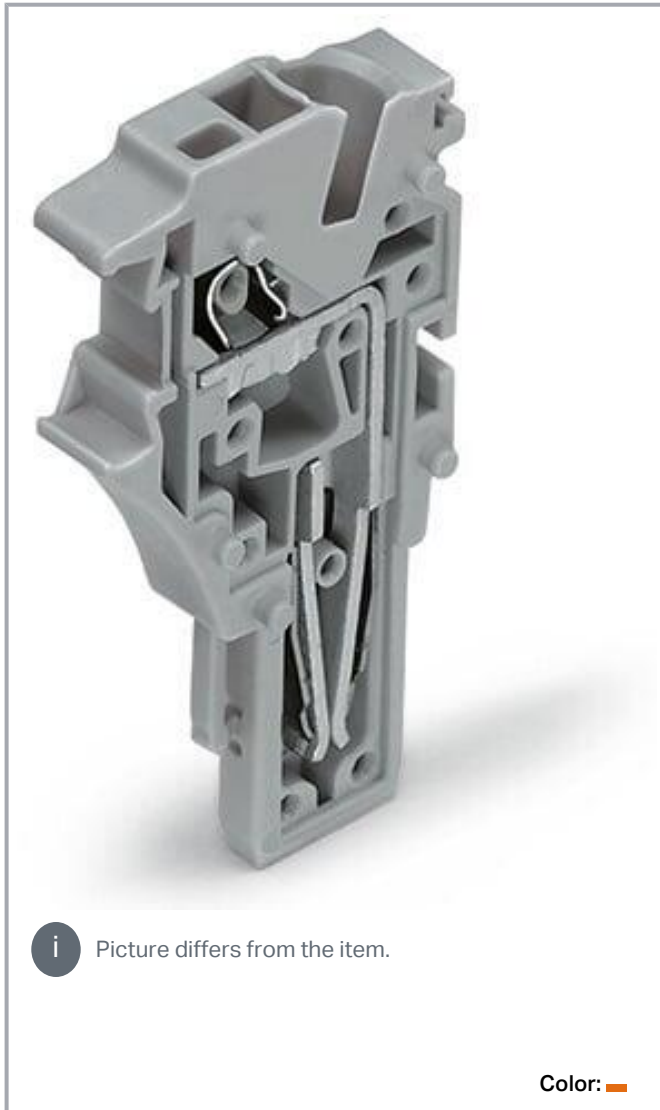

Item description

Customizing Modular Female Plugs

WAGO's modular X-COM®S-SYSTEM female plugs can be customized for applications that require a varying number of poles (e.g., when designing prototypes).

Modules and Pole Numbers

Subject to changes. Please also observe the further product documentation!

WAGO GmbH & Co. KG
Hansastr. 27
32423 Minden
Phone: +49571 887-0 | Fax: +49571 887-169
Email: info.de@wago.com | Web: www.wago.com

Do you have any questions about our products?
We are always happy to take your call at +49 (571) 887-44222.



A customized X-COM®S-SYSTEM female plug consists of:

- One base module with an integrated end plate
- Up to 13 center modules (corresponding to a 15-pole female plug = maximum pole number)
- One end module

Intended Use

According to EN 61984, connectors without current interrupting capacity must not be mated or unmated when live or under load.

Assembly

The appropriate mounting tool shall be used to ensure that the individual modules are properly attached to each other without damaging the locking latches.

Data

Notes

Safety information

According to EN 61984, pluggable connectors without current interrupting capacity must not be mated or unmated when live or under load.

Electrical data

Ratings per IEC/EN

Ratings per	IEC/EN 61984
Nominal voltage (III/3)	690 V
Rated impulse voltage (III/3)	6 kV
Rated current	24 A
Current at conductor cross-section (max.) mm ²	32 A
Legend (ratings)	(III / 3) ≙ Overvoltage category III / Pollution degree 3

Ratings per UL

Approvals per	UL 1059
Rated voltage UL (Use Group B)	600 V
Rated current UL (Use Group B)	20 A
Rated voltage UL (Use Group C)	600 V
Rated current UL (Use Group C)	20 A

Subject to changes. Please also observe the further product documentation!

WAGO GmbH & Co. KG
Hansastr. 27
32423 Minden
Phone: +49571 887-0 | Fax: +49571 887-169
Email: info.de@wago.com | Web: www.wago.com

Do you have any questions about our products?
We are always happy to take your call at +49 (571) 887-44222.



Ratings per CSA

Approvals per	CSA 22.2 No 158
Rated voltage CSA (Use Group C)	600 V
Rated current CSA (Use Group C)	20 A

Connection data

Connection points	1
Total number of potentials	1

Connection 1

Connection technology	Push-in CAGE CLAMP®
Actuation type	Operating tool
Connectable conductor materials	Copper
Nominal cross-section	2.5 mm ²
Solid conductor	0.25 ... 4 mm ² / 22 ... 12 AWG
Solid conductor; push-in termination	0.75 ... 4 mm ² / 18 ... 12 AWG
Fine-stranded conductor	0.25 ... 4 mm ² / 22 ... 12 AWG
Fine-stranded conductor; with insulated ferrule	0.25 ... 2.5 mm ² / 22 ... 14 AWG
Fine-stranded conductor; with ferrule; push-in termination	1 ... 2.5 mm ² / 18 ... 14 AWG
Note (conductor cross-section)	Depending on the conductor characteristic, a conductor with a smaller cross-section can also be inserted via push-in termination.
Strip length	10 ... 12 mm / 0.39 ... 0.47 inches
Pole number	1
Wiring direction	Front-entry wiring

Physical data

Width	5.2 mm / 0.205 inches
Height	40.5 mm / 1.594 inches
Depth	22.4 mm / 0.882 inches

Mechanical Data

Variable coding	Yes
Marking level	Side marking
Anti-rotation protection	Yes

Subject to changes. Please also observe the further product documentation!



Plug-in connection

Contact type (pluggable connector)	Female connector/socket
Connector (connection type)	for conductor
Mismating protection	No
Plugging without loss of pin spacing	Yes

Material data

Note (material data)	Information on material specifications can be found here
Color	orange
Material group	I
Insulation material	Polyamide (PA66)
Flammability class per UL94	V0
Fire load	0.053 MJ
Weight	3.2 g

Environmental requirements

Processing temperature	-35 ... +85 °C
Continuous operating temperature	-60 ... +105 °C

Commercial data

Product Group	18 (X-COM-System)
eCl@ss 10.0	27-14-11-06
eCl@ss 9.0	27-14-11-06
ETIM 8.0	EC001284
ETIM 7.0	EC001284
ECCN	NO DATA
PU (SPU)	250 pcs
Packaging type	Box
Country of origin	CN
GTIN	4050821243410
Customs tariff number	85366990990

Subject to changes. Please also observe the further product documentation!

WAGO GmbH & Co. KG
 Hansastr. 27
 32423 Minden
 Phone: +49571 887-0 | Fax: +49571 887-169
 Email: info.de@wago.com | Web: www.wago.com

Do you have any questions about our products?
 We are always happy to take your call at +49 (571) 887-44222.

Environmental Product Compliance

RoHS Compliance Status

Compliant, No Exemption

Approvals / Certificates

General approvals

Logo	Approval	Additional Approval Text	Certificate name
	CSA DEKRA Certification B.V.	C22.2 No. 158	2437422

Optional accessories

Protective warning marker

Cover



Item no.: 2002-115

Protective warning marker; for 5 terminal blocks; with high-voltage symbol, black; yellow

www.wago.com/2002-115

Strain relief

Strain relief plate



Item no.: 734-326

Strain relief plate; for female and male connectors; 35 mm wide; 1 part; gray

www.wago.com/734-326

Item no.: 734-327

Strain relief plate; for female and male connectors; 6 mm wide; 1 part; gray

www.wago.com/734-327

Item no.: 734-328

Strain relief plate; for female and male connectors; 12.5 mm wide; 1 part; gray

www.wago.com/734-328

Item no.: 734-329

Strain relief plate; for female and male connectors; 25 mm wide; 1 part; gray

www.wago.com/734-329

Item no.: 734-430

Strain relief plate; for female and male connectors; 1 part; gray

www.wago.com/734-430

Subject to changes. Please also observe the further product documentation!

WAGO GmbH & Co. KG

Hansastr. 27

32423 Minden

Phone: +49571 887-0 | Fax: +49571 887-169

Email: info.de@wago.com | Web: www.wago.com

Do you have any questions about our products?











We are always happy to take your call at +49 (571) 887-44222.

**Item no.: 734-431**

Strain relief plate; for female and male connectors; 75 mm wide; 1 part; gray

www.wago.com/734-431**Ferrule**

Ferrule

	Item no.: 216-241 Ferrule; Sleeve for 0.5 mm ² / 20 AWG; insulated; electro-tin plated; electrolytic copper; gastight crimped; acc. to DIN 46228, Part 4/09.90; white	www.wago.com/216-241
	Item no.: 216-242 Ferrule; Sleeve for 0.75 mm ² / 18 AWG; insulated; electro-tin plated; electrolytic copper; gastight crimped; acc. to DIN 46228, Part 4/09.90; gray	www.wago.com/216-242
	Item no.: 216-243 Ferrule; Sleeve for 1 mm ² / AWG 18; insulated; electro-tin plated; electrolytic copper; gastight crimped; acc. to DIN 46228, Part 4/09.90; red	www.wago.com/216-243
	Item no.: 216-244 Ferrule; Sleeve for 1.5 mm ² / AWG 16; insulated; electro-tin plated; electrolytic copper; gastight crimped; acc. to DIN 46228, Part 4/09.90; black	www.wago.com/216-244
	Item no.: 216-263 Ferrule; Sleeve for 1 mm ² / AWG 18; insulated; electro-tin plated; electrolytic copper; gastight crimped; acc. to DIN 46228, Part 4/09.90; red	www.wago.com/216-263
	Item no.: 216-246 Ferrule; Sleeve for 2.5 mm ² / AWG 14; insulated; electro-tin plated; electrolytic copper; gastight crimped; acc. to DIN 46228, Part 4/09.90; blue	www.wago.com/216-246
	Item no.: 216-266 Ferrule; Sleeve for 2.5 mm ² / AWG 14; insulated; electro-tin plated; electrolytic copper; gastight crimped; acc. to DIN 46228, Part 4/09.90; blue	www.wago.com/216-266
	Item no.: 216-264 Ferrule; Sleeve for 1.5 mm ² / AWG 16; insulated; electro-tin plated; electrolytic copper; gastight crimped; acc. to DIN 46228, Part 4/09.90; black	www.wago.com/216-264
	Item no.: 216-286 Ferrule; Sleeve for 2.5 mm ² / AWG 14; insulated; electro-tin plated; electrolytic copper; gastight crimped; acc. to DIN 46228, Part 4/09.90; blue	www.wago.com/216-286
	Item no.: 216-262 Ferrule; Sleeve for 0.75 mm ² / 18 AWG; insulated; electro-tin plated; electrolytic copper; gastight crimped; acc. to DIN 46228, Part 4/09.90; gray	www.wago.com/216-262

Tool

Operating tool

**Item no.: 210-720**

Operating tool; Blade: 3.5 x 0.5 mm; with a partially insulated shaft; multicoloured

www.wago.com/210-720**Insulation stop**

Insulation stop

**Item no.: 2002-171**Insulation stop; 0.25 - 0.5 mm²; 5 pieces/strip; light graywww.wago.com/2002-171

Subject to changes. Please also observe the further product documentation!

WAGO GmbH & Co. KG

Hansastr. 27

32423 Minden

Phone: +49571 887-0 | Fax: +49571 887-169

Email: info.de@wago.com | Web: www.wago.com

Do you have any questions about our products?

We are always happy to take your call at +49 (571) 887-44222.



Item no.: 2002-172
Insulation stop; 0.75 - 1 mm²; 5 pieces/strip; dark gray

www.wago.com/2002-172

Marking accessories

Marking strip



Item no.: 2009-110
Marking strips; for Smart Printer; on reel; not stretchable; plain; snap-on type; white

www.wago.com/2009-110



Item no.: 210-831
Marking strips; on reel; 2.3 mm wide; plain; Self-adhesive; white

www.wago.com/210-831



Item no.: 210-833
Marking strips; 25 m on roll; 6 mm wide; plain; Self-adhesive; white

www.wago.com/210-833



Item no.: 210-834
Marking strips; on reel; 5 mm wide; plain; Self-adhesive; white

www.wago.com/210-834



Item no.: 210-832
Marking strips; on reel; 3 mm wide; plain; Self-adhesive; white

www.wago.com/210-832

Marker



Item no.: 2009-115
WMB-Inline; for Smart Printer; 1500 pieces on roll; stretchable 5 - 5.2 mm; plain; snap-on type; white

www.wago.com/2009-115



Item no.: 793-5501
WMB marking card; as card; for terminal block width 5 - 17.5 mm; stretchable 5 - 5.2 mm; plain; snap-on type; white

www.wago.com/793-5501

Screwless end stop

Mounting accessories



Item no.: 249-117
Screwless end stop; 10 mm wide; for DIN-rail 35 x 15 and 35 x 7.5; gray

www.wago.com/249-117

Locking levers

Locking system



Item no.: 2022-141
Locking lever; gray

www.wago.com/2022-141



Item no.: 2022-151
Locking lever; gray

www.wago.com/2022-151



Item no.: 2022-142
Locking lever; orange

www.wago.com/2022-142

Subject to changes. Please also observe the further product documentation!



Item no.: 2022-152
Locking lever; orange

Downloads

Documentation

Bid Text

2022-182 docx - Datei	2019 May 14	docx 16.5 kB	Download
--------------------------	-------------	-----------------	----------

2022-182 X81 - Datei	2019 Feb 19	xml 4.4 kB	Download
-------------------------	-------------	---------------	----------

Additional Information

		pdf 2.3 MB	Download
--	--	---------------	----------

CAD/CAE-Data

CAD data

2D/3D Models 2022-182		URL	Download
-----------------------	--	-----	----------

CAE data

EPLAN Data Portal 2022-182		URL	Download
----------------------------	--	-----	----------

WSCAD Universe 2022-182		URL	Download
-------------------------	--	-----	----------

ZUKEN Portal 2022-182		URL	Download
-----------------------	--	-----	----------

Asset Administration Shell

Asset Administration Shell 2022-182		URL	Download
-------------------------------------	--	-----	----------

Environmental Product Compliance

Compliance Search

Environmental Product Compliance 2022-182		URL	Download
---	--	-----	----------

End module for 1-conductor female connector; Push-in CAGE CLAMP®; 4 mm²; Pin spacing 5.2 mm; 1-pole; 4,00 mm²; orange

Subject to changes. Please also observe the further product documentation!

Installation Notes

Coding

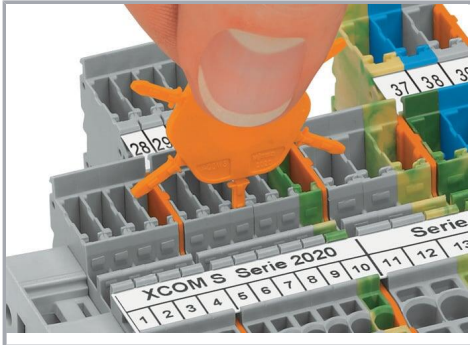

Insert coding pin into the corresponding slot and twist it off.



Coding a female plug: remove coding finger using a suitable tool.

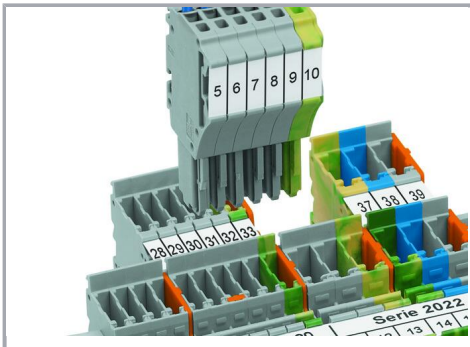

Insert coded female plug into X-COM®S-SYSTEM terminal block assembly.

Locking system

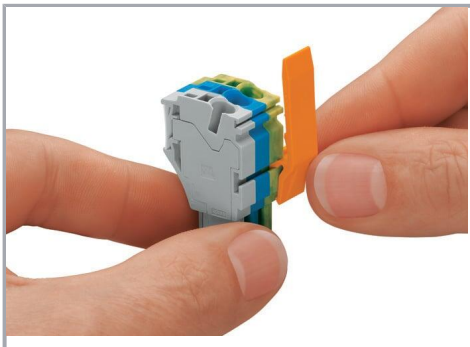

Slide the locking lever into position.

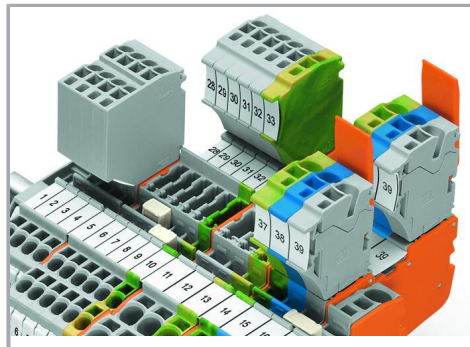

Female plugs can be individually locked.

Product family

Subject to changes. Please also observe the further product documentation!



X-COM S

Show all products from the family

Subject to changes. Please also observe the further product documentation!

WAGO GmbH & Co. KG
Hansastr. 27
32423 Minden
Phone: +49571 887-0 | Fax: +49571 887-169
Email: info.de@wago.com | Web: www.wago.com

Do you have any questions about our products?
We are always happy to take your call at +49 (571) 887-44222.