

## Data sheet | Item number: 890-124

Socket; with strain relief housing; 4-pole; Cod. A; 1,50 mm<sup>2</sup>; white

[www.wago.com/890-124](http://www.wago.com/890-124)

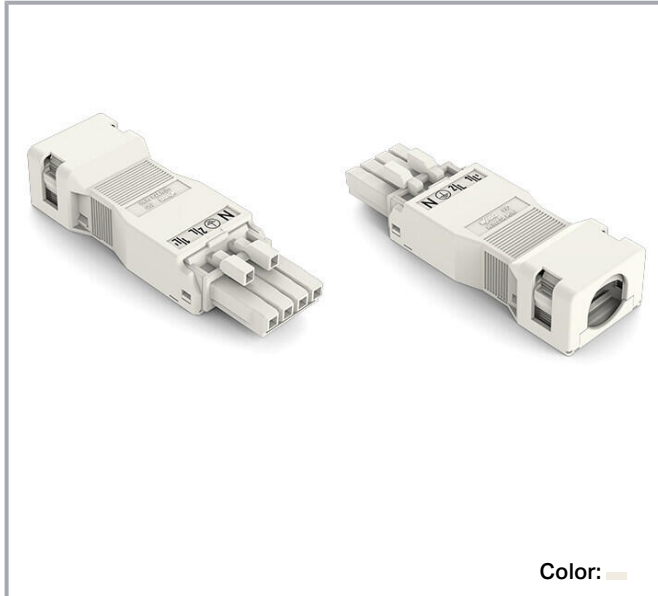

Color: 

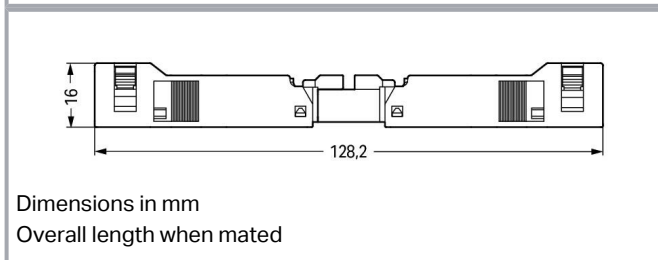
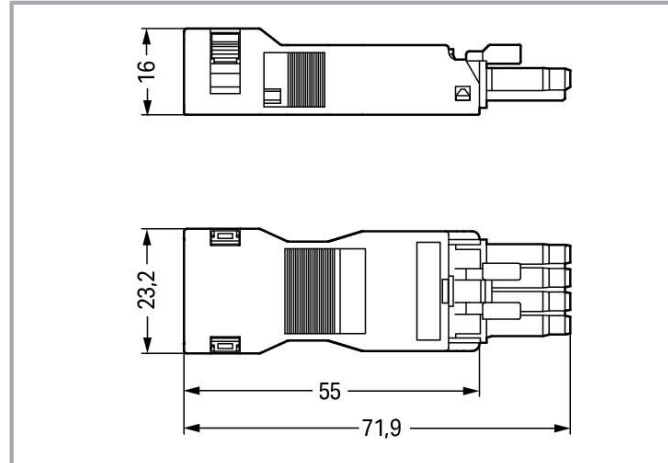

Dimensions in mm  
Overall length when mated

## Item description

### Female connector/socket *WINSTA*® MINI rated current 16 A

For power and signal transmission: The *WINSTA*® MINI female connector/socket 4-pole. On PCBs, in control cabinets or for connecting lights – pluggable installation connectors from WAGO allow you to establish connections according to many different requirements in seconds. The coding options reduce installation errors, allowing fast, maintenance-free wiring of all components. The pluggable installation connector is protected in accordance with protection type IP40. Users' fingers and tools will never come into contact with live elements. General mains applications for almost any domain of use can be realised with *WINSTA*® MINI pluggable installation connectors with A coding. *WINSTA*® MINI satisfies the demand for miniaturisation. Our smallest pluggable connection system is very good for lights, for instance, since as a result of LED technology; due to complex systems, these offer much less space for the connection technology. The strip length is 45 mm.

Subject to changes. Please also observe the further product documentation!

WAGO GmbH & Co. KG  
Hansastr. 27  
32423 Minden  
Phone: +49571 887-0 | Fax: +49571 887-169  
Email: [info.de@wago.com](mailto:info.de@wago.com) | Web: [www.wago.com](http://www.wago.com)

Do you have any questions about our products?  
We are always happy to take your call at +49 (571) 887-44222.



## Lower costs through fast commissioning and elimination of service expenses – solutions from WINSTA® MINI

The WINSTA® Pluggable Connection System is ideally tailored to the very strict requirements of building installation. It makes electrical installation pluggable, and thus faster, even more reliable, and error-free. Using this pre-assembled system reduces time spent on assembly and errors during installation at the construction site. Choose quality and durability – with protection against mismatching from WAGO makes the installation of electrical components substantially easier.

- effective protection against mismatching
- consistent IP40 protection
- suitable for any application
- custom-engineered solutions
- quick replacement of defective units during ongoing operation

### Data

#### Electrical data

#### Ratings per IEC/EN

Ratings per	IEC/EN 60664-1
Nominal voltage (III/3)	400 V
Rated impulse voltage (III/3)	6 kV
Rated current	16 A
Legend (ratings)	(III / 3) ≙ Overvoltage category III / Pollution degree 3

#### Ratings per UL 1977

Note for the US market	Some versions may also be used for current interruption in accordance with the UL certificate in select applications with currents below 5 A and voltages up to 600 V. For further information, please contact your local sales office.
Rated voltage (UL 1977)	600 V
Rated current UL 1977	12 A

#### General information

Note on contact resistance	approx. 1 mΩ of contact resistance approx. 0.25 mΩ contact transition plug/socket
----------------------------	--

Subject to changes. Please also observe the further product documentation!

WAGO GmbH & Co. KG  
 Hansastr. 27  
 32423 Minden  
 Phone: +49571 887-0 | Fax: +49571 887-169  
 Email: [info.de@wago.com](mailto:info.de@wago.com) | Web: [www.wago.com](http://www.wago.com)

Do you have any questions about our products?  
 We are always happy to take your call at +49 (571) 887-44222.



## Connection data

Connection points	4
Total number of potentials	4

## Connection 1

Connection technology	Push-in CAGE CLAMP®
Actuation type	Operating tool Push-in
Nominal cross-section	1.5 mm <sup>2</sup> / 16 AWG
Solid conductor	0.25 ... 1.5 mm <sup>2</sup> / 22 ... 16 AWG
Solid conductor; push-in termination	0.75 ... 1.5 mm <sup>2</sup> / 20 ... 16 AWG
Stranded conductor	0.25 ... 1 mm <sup>2</sup> / 22 ... 18 AWG
Fine-stranded conductor	0.25 ... 1.5 mm <sup>2</sup> / 22 ... 16 AWG
Fine-stranded conductor; with insulated ferrule	0.25 ... 0.75 mm <sup>2</sup> / 22 ... 20 AWG
Fine-stranded conductor; with uninsulated ferrule	0.25 ... 0.75 mm <sup>2</sup> / 22 ... 20 AWG
Fine-stranded conductor; with ferrule; push-in termination	0.75 mm <sup>2</sup> / 20 AWG
Strip length	9 mm / 0.35 inches
Pole number	4
Conductor entry direction to mating direction	0°
Strip length (outer insulation)	45 mm

## Physical data

Pin spacing	4.4 mm / 0.173 inches
Width	23.2 mm / 0.913 inches
Height	16 mm / 0.63 inches
Depth	71.9 mm / 2.831 inches

## Mechanical Data

Application	General mains applications
Coding	A
Variable coding	No
Marking	N $\frac{2}{L}$ 1/L'
Potential marking	N $\frac{2}{L}$ 1/L'
Mating force of a plug-in connection	approx. 20 ... 70 N (depending on pole number)
Retention force of a plug-in connection	Locked: > 80 N

Subject to changes. Please also observe the further product documentation!



Unmating force of a plug-in connection	Unlocked: approx. 20 ... 70 N (depending on pole number)
Number of mating cycles	200, without resistive load
Protection type	IP40

### Plug-in connection

Contact type (pluggable connector)	Female connector/socket
Connector (connection type)	for conductor
Mismating protection	Yes
Note on mismating protection	All <i>WINSTA</i> <sup>®</sup> components are 100% protected against mismating when: a.) plugging different numbers of poles b.) plugging while rotated 180 c.) plugging while laterally staggered d.) plugging one pole
Locking lever	Can be retrofitted
Locking of plug-in connection	locking lever
Note on locking system	All connectors for mounted installations (snap-in versions for lighting fixtures or devices, all types of PCB and distribution connectors) are factory-equipped with locking levers to ensure plugs and sockets are securely locked. Additional locking levers are only required for flying leads (plug/socket).
Strain relief	strain relief housing

### Material data

Note (material data)	Information on material specifications can be found here
Color	white
Cover color	gray
Material group	I
Insulation material	Polyamide (PA66)
Flammability class per UL94	V0
Clamping spring material	Chrome-nickel spring steel (CrNi)
Contact material	Copper or copper alloy; surface-treated
Contact plating	Tin
Fire load	0.29 MJ
Weight	10.6 g

Subject to changes. Please also observe the further product documentation!

WAGO GmbH & Co. KG  
Hansastr. 27  
32423 Minden  
Phone: +49571 887-0 | Fax: +49571 887-169  
Email: [info.de@wago.com](mailto:info.de@wago.com) | Web: [www.wago.com](http://www.wago.com)

Do you have any questions about our products?  
We are always happy to take your call at +49 (571) 887-44222.

## Environmental requirements

Processing temperature	-5 ... +40 °C
Continuous operating temperature	-35 ... +85 °C
Note on continuous operating temperature	Insulating parts for temperatures ≤ 105 °C

## Commercial data



Product Group	20 (Winsta)
eCl@ss 10.0	27-44-06-05
eCl@ss 9.0	27-44-06-05
ETIM 8.0	EC002560
ETIM 7.0	EC002560
ECCN	NO DATA
PU (SPU)	50 pcs
Packaging type	box
Country of origin	DE
GTIN	4045454232979
Customs tariff number	85366990990

## Environmental Product Compliance

RoHS Compliance Status	Compliant, No Exemption
------------------------	-------------------------

## Approvals / Certificates

### General approvals



Logo	Approval	Additional Approval Text	Certificate name
	CCA DEKRA Certification B.V.	EN 61535	71-123231
	CCA DEKRA Certification B.V.	IEC 61535	NL-85020
	cURus Underwriters Laboratories Inc.	UL 1977	E45171

## Declarations of conformity and manufacturer's declarations



Subject to changes. Please also observe the further product documentation!

WAGO GmbH & Co. KG  
 Hansastr. 27  
 32423 Minden  
 Phone: +49571 887-0 | Fax: +49571 887-169  
 Email: [info.de@wago.com](mailto:info.de@wago.com) | Web: [www.wago.com](http://www.wago.com)







Do you have any questions about our products?  
 We are always happy to take your call at +49 (571) 887-44222.

Logo	Approval	Additional Approval Text	Certificate name
	EU-Declaration of Conformity WAGO GmbH & Co. KG	-	-
	UK-Declaration of Conformity WAGO GmbH & Co. KG	-	-

## Approvals for marine applications

Logo	Approval	Additional Approval Text	Certificate name
	ABS American Bureau of Shipping	Steel Vessel Rules	19- HG1869855- PDA
	DNV GL Det Norske Veritas, Germanischer Lloyd	-	TAE00001Z6
	LR Lloyds Register	EN 61535	08/20047 (E2)

## Counterpart

	<b>Item no.890-134</b> Plug; with strain relief housing; 4-pole; 1,50 mm <sup>2</sup> ; white	<a href="http://www.wago.com/890-134">www.wago.com/890-134</a>
	<b>Item no.890-234</b> Plug; 4-pole; Cod. A; 1,50 mm <sup>2</sup> ; white	<a href="http://www.wago.com/890-234">www.wago.com/890-234</a>
	<b>Item no.890-676</b> T-distribution connector; 4-pole; Cod. A; 1 input; 2 outputs; 2 locking levers; white	<a href="http://www.wago.com/890-676">www.wago.com/890-676</a>
	<b>Item no.890-677</b> T-distribution connector; 4-pole; Cod. A; 1 input; 2 outputs; 3 locking levers; for flying leads; white	<a href="http://www.wago.com/890-677">www.wago.com/890-677</a>
	<b>Item no.890-734</b> Snap-in plug; 4-pole; Cod. A; 1,50 mm <sup>2</sup> ; white	<a href="http://www.wago.com/890-734">www.wago.com/890-734</a>
	<b>Item no.890-834</b> Plug for PCBs; straight; 4-pole; Cod. A; white	<a href="http://www.wago.com/890-834">www.wago.com/890-834</a>

Subject to changes. Please also observe the further product documentation!



**Item no.890-834/011-000**  
Plug for PCBs; angled; 4-pole; Cod. A; white

[www.wago.com/890-834/011-000](http://www.wago.com/890-834/011-000)



**Item no.890-995**  
h-distribution connector; 4-pole; Cod. A; 1 input; 2 outputs; outputs on one side; 3 locking levers; for flying leads; white

[www.wago.com/890-995](http://www.wago.com/890-995)



**Item no.890-994**  
h-distribution connector; 4-pole; Cod. A; 1 input; 2 outputs; outputs on one side; 2 locking levers; white

[www.wago.com/890-994](http://www.wago.com/890-994)



**Item no.891-8994/006-102**  
pre-assembled interconnecting cable; Eca; Socket/plug; 4-pole; Cod. A; H05VV-F 4G 1.5 mm<sup>2</sup>; 1 m; 1,50 mm<sup>2</sup>; white

[www.wago.com/891-8994/006-102](http://www.wago.com/891-8994/006-102)

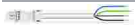

**Item no.891-8994/206-102**  
pre-assembled connecting cable; Eca; Plug/open-ended; 4-pole; Cod. A; H05VV-F 4G 1.5 mm<sup>2</sup>; 1 m; 1,50 mm<sup>2</sup>; white

[www.wago.com/891-8994/206-102](http://www.wago.com/891-8994/206-102)

## Required accessories

### Locking levers

#### Locking system



**Item no.: 890-111**  
Locking lever; for flying leads; for tool operation; black

[www.wago.com/890-111](http://www.wago.com/890-111)



**Item no.: 890-101**  
Locking lever; for manual operation; black

[www.wago.com/890-101](http://www.wago.com/890-101)



**Item no.: 890-121**  
Locking lever; for manual operation; white

[www.wago.com/890-121](http://www.wago.com/890-121)



**Item no.: 890-131**  
Locking lever; for flying leads; for tool operation; white

[www.wago.com/890-131](http://www.wago.com/890-131)

## Optional accessories

### Cover

#### Cover



**Item no.: 897-2003**  
Protective cap; Type2; for sockets and plugs; PVC; red

[www.wago.com/897-2003](http://www.wago.com/897-2003)

Subject to changes. Please also observe the further product documentation!

## Mounting

### Mounting accessories



**Item no.: 890-310**  
Mounting carrier; 2- to 5-pole; for flying leads; black

[www.wago.com/890-310](http://www.wago.com/890-310)



**Item no.: 890-311**  
Mounting carrier; 2- to 5-pole; for flying leads; white

[www.wago.com/890-311](http://www.wago.com/890-311)

## Tool

### Operating tool



**Item no.: 210-719**  
Operating tool; Blade: 2.5 x 0.4 mm; with a partially insulated shaft

[www.wago.com/210-719](http://www.wago.com/210-719)



**Item no.: 890-384**  
Operating tool; 4-way; green

[www.wago.com/890-384](http://www.wago.com/890-384)

## Shield termination

### Shield termination



**Item no.: 890-524**  
Shield connecting plate; 4-pole; for sockets

[www.wago.com/890-524](http://www.wago.com/890-524)

## Downloads

### Documentation

#### Bid Text

890-124 X81 - Datei	2019 Feb 19	xml 3.1 kB	Download
890-124 doc - Datei	2015 Jun 8	doc 23.6 kB	Download

### CAD/CAE-Data

#### CAD data

2D/3D Models 890-124	URL	Download
----------------------	-----	----------

#### CAE data

WSCAD Universe 890-124

Subject to changes. Please also observe the further product documentation!

WAGO GmbH & Co. KG  
Hansastr. 27  
32423 Minden  
Phone: +49571 887-0 | Fax: +49571 887-169  
Email: [info.de@wago.com](mailto:info.de@wago.com) | Web: [www.wago.com](http://www.wago.com)

Do you have any questions about our products?  
We are always happy to take your call at +49 (571) 887-44222.



[URL](#) [Download](#)

ZUKEN Portal 890-124

[URL](#) [Download](#)

### Asset Administration Shell

Asset Administration Shell 890-124

[URL](#) [Download](#)

## Environmental Product Compliance

### Compliance Search

Environmental Product Compliance 890-124

[URL](#) [Download](#)

Socket; with strain relief housing; 4-pole; Cod. A; 1,50 mm<sup>2</sup>; white

## Installation Notes

### Conductor termination

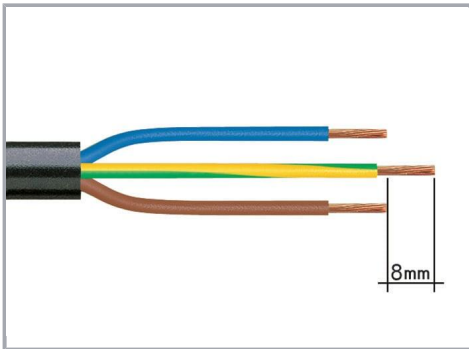

1. Strip length, outer insulation = 30 mm (2-pole), 37 mm (3-pole), 45 mm (4- and 5-pole)
2. Strip length = 9 mm
3. Extended ground conductor = 8 mm

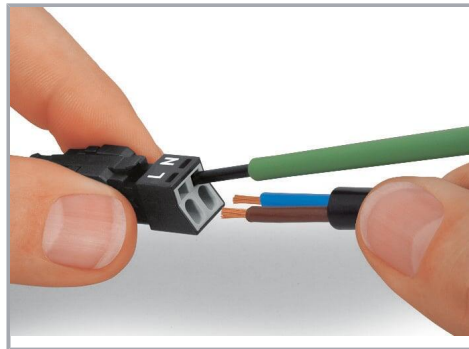

To terminate fine-stranded conductors, open the clamping unit via screwdriver – 2.5 mm blade width – and insert a stripped conductor until it hits the backstop. Terminate solid conductors by simply pushing them in.

Subject to changes. Please also observe the further product documentation!

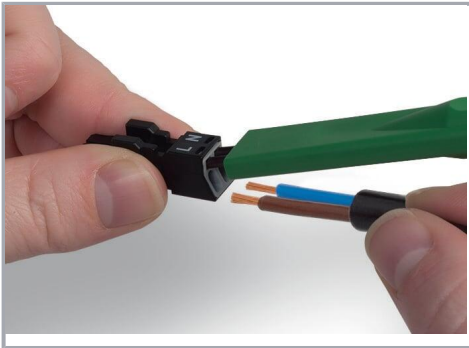

To terminate fine-stranded conductors, open clamping units via operating tool (890-382) and insert stripped conductors until they hit backstop. Terminate solid conductors by simply pushing them in.

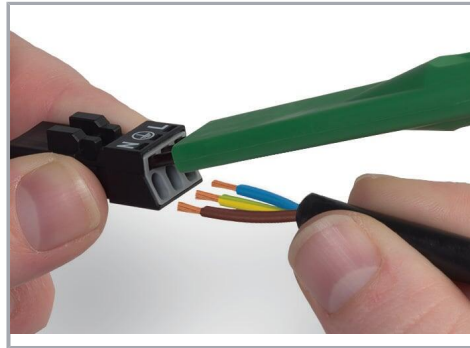

To terminate fine-stranded conductors, open clamping units via operating tool (890-383) and insert stripped conductors until they hit backstop. Terminate solid conductors by simply pushing them in.

### Installation

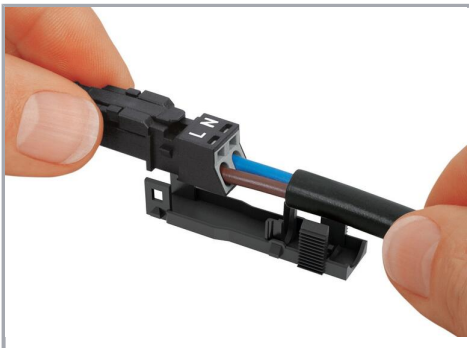

Latch the wired connector into the base of the strain relief housing.



Push down strain relief clamp by hand.



Push down strain relief clamp with 2.5 mm screwdriver alternately on both sides.

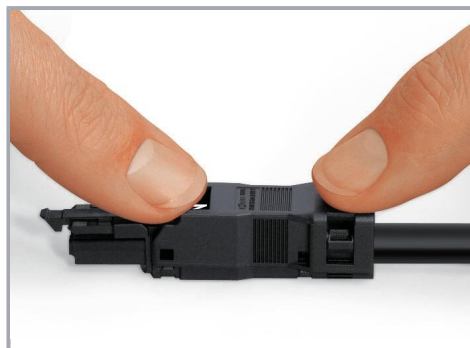

Latch the top of the strain relief housing.

Subject to changes. Please also observe the further product documentation!



The printed marking of the connector is clearly visible in the openings of the strain relief housing.

### Shield termination



Connector with shield termination



Apply the shield to the sheathed cable.

Strip length, outer insulation = 30 mm  
Shield length = 8 mm



Push the shield connecting plate into the connector until fully inserted.

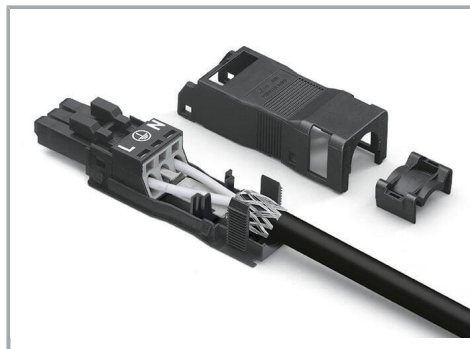

First insert the wired connector into strain relief housing, then snap clamp and cover.

### Product family

Subject to changes. Please also observe the further product documentation!



**WINSTA® MINI**

[Show all products from the family](#)

Subject to changes. Please also observe the further product documentation!

---

WAGO GmbH & Co. KG  
Hansastr. 27  
32423 Minden  
Phone: +49571 887-0 | Fax: +49571 887-169  
Email: [info.de@wago.com](mailto:info.de@wago.com) | Web: [www.wago.com](http://www.wago.com)

Do you have any questions about our products?  
We are always happy to take your call at +49 (571) 887-44222.