

Data sheet | Item number: 231-203/037-000

1-conductor female connector; CAGE CLAMP®; 2.5 mm²; Pin spacing 7.5 mm; 3-pole; Lateral locking levers; 2,50 mm²; gray

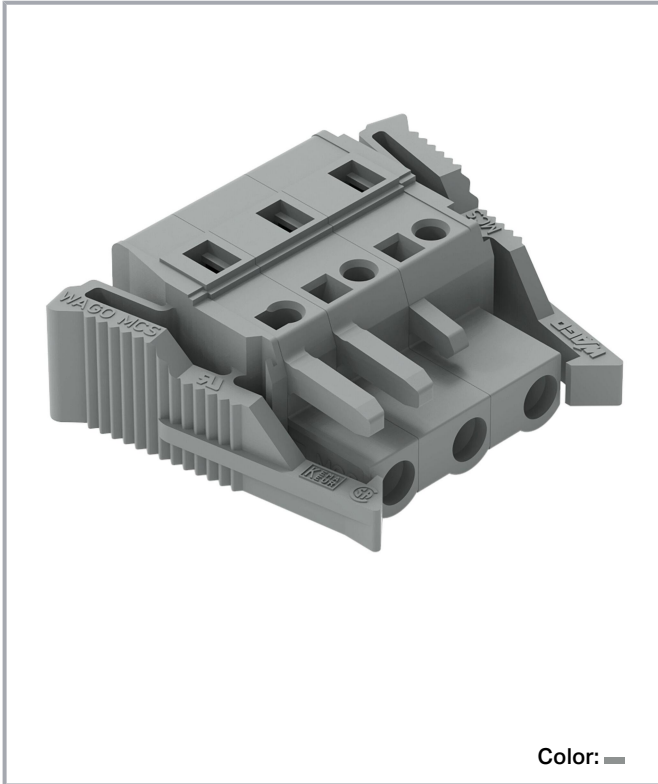

www.wago.com/231-203/037-000



Color: ■

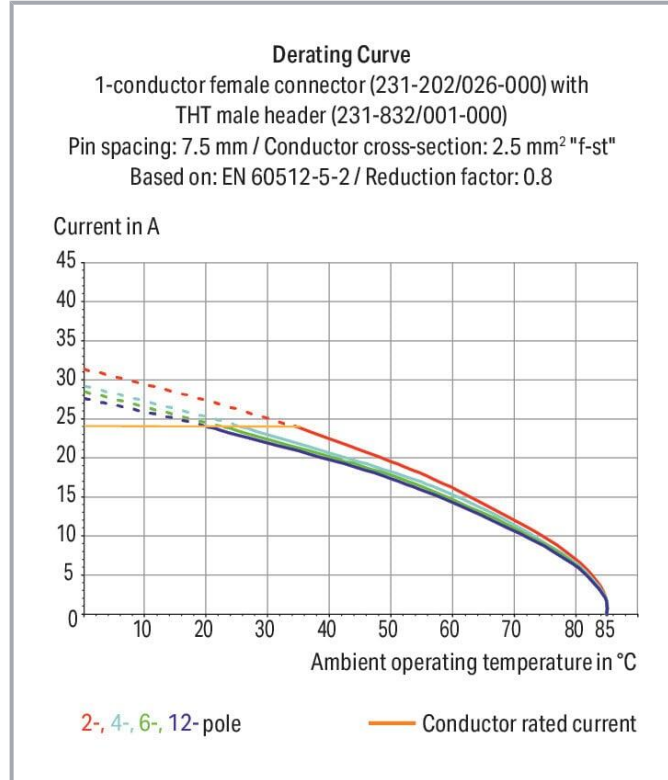

Subject to changes. Please also observe the further product documentation!

WAGO GmbH & Co. KG
Hansastr. 27
32423 Minden
Phone: +49571 887-0 | Fax: +49571 887-169
Email: info.de@wago.com | Web: www.wago.com

Do you have any questions about our products?
We are always happy to take your call at +49 (571) 887-44222.

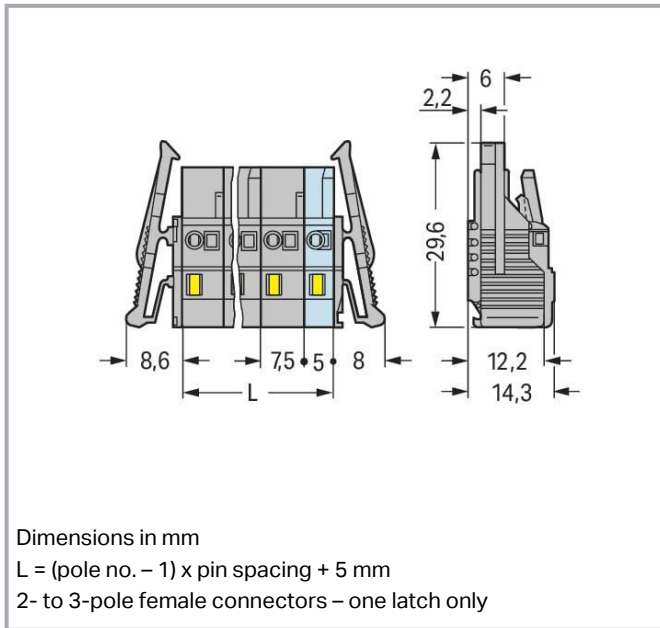

Item description

- Universal connection for all conductor types
- Easy cable pre-assembly and on-unit wiring via vertical and horizontal CAGE CLAMP® actuation
- Integrated test ports
- With coding fingers

Data

Notes

Safety information

The *MCS – MULTI CONNECTION SYSTEM* includes connectors without breaking capacity in accordance with DIN EN 61984. When used as intended, these connectors must not be connected /disconnected when live or under load. When used as intended, these connectors must not be connected/disconnected when live or under load. The circuit design should ensure header pins, which can be touched, are not live when unmated.

Variants:

Gold-plated or partially gold-plated contact surfaces
 Other versions (or variants) can be requested from WAGO Sales or configured at <https://configurator.wago.com/>.

Electrical data

Subject to changes. Please also observe the further product documentation!

WAGO GmbH & Co. KG
 Hansastr. 27
 32423 Minden
 Phone: +49571 887-0 | Fax: +49571 887-169
 Email: info.de@wago.com | Web: www.wago.com

Do you have any questions about our products?
 We are always happy to take your call at +49 (571) 887-44222.



Ratings per IEC/EN

| Ratings per | IEC/EN 60664-1 |
|-------------------------------|--|
| Nominal voltage (III/3) | 500 V |
| Rated impulse voltage (III/3) | 6 kV |
| Rated voltage (III/2) | 630 V |
| Rated impulse voltage (III/2) | 6 kV |
| Nominal voltage (II/2) | 1000 V |
| Rated surge voltage (II/2) | 6 kV |
| Rated current | 16 A |
| Legend (ratings) | (III / 2) \triangleq Overvoltage category III / Pollution degree 2 |

Ratings per UL

| Approvals per | UL 1059 |
|--------------------------------|---------|
| Rated voltage UL (Use Group B) | 300 V |
| Rated current UL (Use Group B) | 15 A |
| Rated voltage UL (Use Group D) | 300 V |
| Rated current UL (Use Group D) | 10 A |

Ratings per UL 1977

| | |
|-------------------------|-------|
| Rated voltage (UL 1977) | 600 V |
| Rated current UL 1977 | 15 A |

Ratings per CSA

| Approvals per | CSA |
|---------------------------------|-------|
| Rated voltage CSA (Use Group B) | 300 V |
| Rated current CSA (Use Group B) | 15 A |
| Rated voltage CSA (Use Group D) | 300 V |
| Rated current CSA (Use Group D) | 10 A |

Connection data

| | |
|----------------------------|---|
| Connection points | 3 |
| Total number of potentials | 3 |
| Number of connection types | 1 |
| Number of levels | 1 |

Subject to changes. Please also observe the further product documentation!

WAGO GmbH & Co. KG
 Hansastr. 27
 32423 Minden
 Phone: +49571 887-0 | Fax: +49571 887-169
 Email: info.de@wago.com | Web: www.wago.com

Do you have any questions about our products?
 We are always happy to take your call at +49 (571) 887-44222.

Connection 1

| | |
|---|--|
| Connection technology | CAGE CLAMP® |
| Actuation type | Operating tool |
| Actuation direction 1 | Operation parallel to conductor entry |
| Actuation direction 2 | Operation perpendicular to conductor entry |
| Solid conductor | 0.08 ... 2.5 mm ² / 28 ... 12 AWG |
| Fine-stranded conductor | 0.08 ... 2.5 mm ² / 28 ... 12 AWG |
| Fine-stranded conductor; with insulated ferrule | 0.25 ... 1.5 mm ² |
| Fine-stranded conductor; with uninsulated ferrule | 0.25 ... 2.5 mm ² |
| Strip length | 8 ... 9 mm / 0.31 ... 0.35 inches |
| Pole number | 3 |
| Conductor entry direction to mating direction | 0° |

Physical data

| | |
|-------------|------------------------|
| Pin spacing | 7.5 mm / 0.295 inches |
| Width | 36.6 mm / 1.441 inches |
| Height | 14.3 mm / 0.563 inches |
| Depth | 29.6 mm / 1.165 inches |

Mechanical Data

| | |
|--------------------------|-----|
| Variable coding | Yes |
| Anti-rotation protection | Yes |

Plug-in connection

| | |
|--------------------------------------|-------------------------|
| Contact type (pluggable connector) | Female connector/socket |
| Connector (connection type) | for conductor |
| Mismating protection | No |
| Plugging without loss of pin spacing | No |
| Locking of plug-in connection | locking lever |

Material data

| | |
|----------------------|--|
| Note (material data) | Information on material specifications can be found here |
| Color | gray |
| Material group | I |

Subject to changes. Please also observe the further product documentation!



| | |
|-----------------------------|-----------------------------------|
| Insulation material | Polyamide (PA66) |
| Flammability class per UL94 | V0 |
| Clamping spring material | Chrome-nickel spring steel (CrNi) |
| Contact material | Copper alloy |
| Contact plating | Tin |
| Fire load | 0.302 MJ |
| Weight | 7.6 g |

Environmental requirements

| | |
|-------------------------|----------------|
| Limit temperature range | -60 ... +85 °C |
| Processing temperature | -35 ... +60 °C |

Commercial data

| | |
|-----------------------|------------------------|
| Product Group | 3 (Multi Conn. System) |
| eCl@ss 10.0 | 27-44-03-09 |
| eCl@ss 9.0 | 27-44-03-09 |
| ETIM 8.0 | EC002638 |
| ETIM 7.0 | EC002638 |
| ECCN | NO DATA |
| PU (SPU) | 50 pcs |
| Packaging type | box |
| Country of origin | DE |
| GTIN | 4044918366854 |
| Customs tariff number | 85366990990 |

Environmental Product Compliance

| | |
|------------------------|-------------------------|
| RoHS Compliance Status | Compliant, No Exemption |
|------------------------|-------------------------|

Approvals / Certificates





General approvals

| Logo | Approval | Additional Approval Text | Certificate name |
|--|--------------------------------|--------------------------|------------------|
| | CB DEKRA Certification B.V. | IEC 61984 | NL-39756/A1 |
|  | CCC CQC | GB/T 13140.1 | CQC03003003013 |

Subject to changes. Please also observe the further product documentation!

WAGO GmbH & Co. KG
 Hansastr. 27
 32423 Minden
 Phone: +49571 887-0 | Fax: +49571 887-169
 Email: info.de@wago.com | Web: www.wago.com

Do you have any questions about our products?
 We are always happy to take your call at +49 (571) 887-44222.

| | | | |
|--|---------------------------------------|----------|-----------|
|  | CSA DEKRA Certification B.V. | C22.2 | 1466354 |
|  | KEMA/KEUR DEKRA Certification B.V. | EN 61984 | 71-121453 |
|  | UR Underwriters Laboratories Inc. | UL 1059 | E45172 |
|  | UR Underwriters Laboratories Inc. | UL 1977 | E 45171 |

Declarations of conformity and manufacturer's declarations

| Logo | Approval | Additional Approval Text | Certificate name |
|---|-------------------------------|--------------------------|------------------|
|  | Railway WAGO GmbH & Co. KG | - | Railway Ready |

Approvals for marine applications

| Logo | Approval | Additional Approval Text | Certificate name |
|---|------------------------------------|--------------------------|------------------|
|  | ABS American Bureau of Shipping | - | 19-HG1869876-PDA |
|  | BV Bureau Veritas S.A. | IEC 60998 | 11915/DO BV |
|  | DNV DNV GL SE | - | TAE000016Z |

Subject to changes. Please also observe the further product documentation!

WAGO GmbH & Co. KG
 Hansastr. 27
 32423 Minden
 Phone: +49571 887-0 | Fax: +49571 887-169
 Email: info.de@wago.com | Web: www.wago.com

Do you have any questions about our products?
 We are always happy to take your call at +49 (571) 887-44222.

Counterpart



Item no.731-603

1-conductor male connector; CAGE CLAMP®; 2.5 mm²; Pin spacing 7.5 mm; 3-pole; 2,50 mm²; gray

www.wago.com/731-603

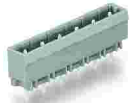

Item no.231-233/001-000

THT male header; 1.0 x 1.0 mm solder pin; straight; Pin spacing 7.5 mm; 3-pole; gray

www.wago.com/231-233/001-000



Item no.231-833/001-000

THT male header; 1.0 x 1.0 mm solder pin; angled; Pin spacing 7.5 mm; 3-pole; gray

www.wago.com/231-833/001-000

Optional accessories

Insulation stop

Insulation stop



Item no.: 231-673

Insulation stop; 0.08-0.2 mm² / 0.2 mm² "s"; white

www.wago.com/231-673



Item no.: 231-674

Insulation stop; 0.25 - 0.5 mm²; light gray

www.wago.com/231-674



Item no.: 231-675

Insulation stop; 0.75 - 1 mm²; dark gray

www.wago.com/231-675

Cover

Cover



Item no.: 231-668

Lockout caps; for covering unused clamping units; gray

www.wago.com/231-668

Testing and measuring

Testing accessories



Item no.: 210-136

Test plug; 2 mm Ø; with 500 mm cable; red

www.wago.com/210-136



Item no.: 231-662

Test plugs for female connectors; for 7.5 mm and 7.62 mm pin spacing; 2,50 mm²; light gray

www.wago.com/231-662

Marking accessories

Marking strip

Subject to changes. Please also observe the further product documentation!

WAGO GmbH & Co. KG

Hansastr. 27















32423 Minden

Phone: +49571 887-0 | Fax: +49571 887-169

Email: info.de@wago.com | Web: www.wago.com

Do you have any questions about our products?

We are always happy to take your call at +49 (571) 887-44222.

| | | |
|---|--|--|
|  | Item no.: 210-331/750-202 Marking strips; as a DIN A4 sheet; MARKED; 1-16 (100x); Height of marker strip: 2.3 mm/0.091 in; Strip length 182 mm; Horizontal marking; Self-adhesive; white | www.wago.com/210-331/750-202 |
|  | Item no.: 210-332/750-020 Marking strips; as a DIN A4 sheet; MARKED; 1-20 (80x); Height of marker strip: 3 mm; Strip length 182 mm; Horizontal marking; Self-adhesive; white | www.wago.com/210-332/750-020 |
| Tool | | |
| Operating tool | | |
|  | Item no.: 210-657 Operating tool; Blade: 3.5 x 0.5 mm; with a partially insulated shaft; short; multicoloured | www.wago.com/210-657 |
|  | Item no.: 210-720 Operating tool; Blade: 3.5 x 0.5 mm; with a partially insulated shaft; multicoloured | www.wago.com/210-720 |
|  | Item no.: 231-131 Operating tool; made of insulating material; 1-way; loose; white | www.wago.com/231-131 |
|  | Item no.: 231-291 Operating tool; made of insulating material; 1-way; loose; red | www.wago.com/231-291 |
| Ferrule | | |
| Ferrule | | |
|  | Item no.: 216-101 Ferrule; Sleeve for 0.5 mm ² / AWG 22; uninsulated; electro-tin plated; silver-colored | www.wago.com/216-101 |
|  | Item no.: 216-104 Ferrule; Sleeve for 1.5 mm ² / AWG 16; uninsulated; electro-tin plated; silver-colored | www.wago.com/216-104 |
|  | Item no.: 216-106 Ferrule; Sleeve for 2.5 mm ² / AWG 14; uninsulated; electro-tin plated; silver-colored | www.wago.com/216-106 |
|  | Item no.: 216-102 Ferrule; Sleeve for 0.75 mm ² / AWG 20; uninsulated; electro-tin plated; silver-colored | www.wago.com/216-102 |
|  | Item no.: 216-103 Ferrule; Sleeve for 1 mm ² / AWG 18; uninsulated; electro-tin plated | www.wago.com/216-103 |
|  | Item no.: 216-123 Ferrule; Sleeve for 1 mm ² / AWG 18; uninsulated; electro-tin plated; silver-colored | www.wago.com/216-123 |
|  | Item no.: 216-122 Ferrule; Sleeve for 0.75 mm ² / AWG 20; uninsulated; electro-tin plated; silver-colored | www.wago.com/216-122 |
|  | Item no.: 216-124 Ferrule; Sleeve for 1.5 mm ² / AWG 16; uninsulated; electro-tin plated | www.wago.com/216-124 |











Subject to changes. Please also observe the further product documentation!



| | | |
|---|---|--|
|  | Item no.: 216-142 Ferrule; Sleeve for 0.75 mm ² / 18 AWG; uninsulated; electro-tin plated; electrolytic copper; gastight crimped; acc. to DIN 46228, Part 1/08.92 | www.wago.com/216-142 |
|  | Item no.: 216-132 Ferrule; Sleeve for 0.34 mm ² / AWG 24; uninsulated; electro-tin plated | www.wago.com/216-132 |
|  | Item no.: 216-121 Ferrule; Sleeve for 0.5 mm ² / AWG 22; uninsulated; electro-tin plated; silver-colored | www.wago.com/216-121 |
|  | Item no.: 216-143 Ferrule; Sleeve for 1 mm ² / AWG 18; uninsulated; electro-tin plated; electrolytic copper; gastight crimped; acc. to DIN 46228, Part 1/08.92 | www.wago.com/216-143 |
|  | Item no.: 216-131 Ferrule; Sleeve for 0.25 mm ² / AWG 24; uninsulated; electro-tin plated; silver-colored | www.wago.com/216-131 |
|  | Item no.: 216-141 Ferrule; Sleeve for 0.5 mm ² / 20 AWG; uninsulated; electro-tin plated; electrolytic copper; gastight crimped; acc. to DIN 46228, Part 1/08.92 | www.wago.com/216-141 |
|  | Item no.: 216-152 Ferrule; Sleeve for 0.34 mm ² / AWG 24; uninsulated; electro-tin plated | www.wago.com/216-152 |
|  | Item no.: 216-203 Ferrule; Sleeve for 1 mm ² / AWG 18; insulated; electro-tin plated; red | www.wago.com/216-203 |
|  | Item no.: 216-202 Ferrule; Sleeve for 0.75 mm ² / 18 AWG; insulated; electro-tin plated; gray | www.wago.com/216-202 |
|  | Item no.: 216-151 Ferrule; Sleeve for 0.25 mm ² / AWG 24; uninsulated; electro-tin plated | www.wago.com/216-151 |
|  | Item no.: 216-204 Ferrule; Sleeve for 1.5 mm ² / AWG 16; insulated; electro-tin plated; black | www.wago.com/216-204 |
|  | Item no.: 216-144 Ferrule; Sleeve for 1.5 mm ² / AWG 16; uninsulated; electro-tin plated; electrolytic copper; gastight crimped; acc. to DIN 46228, Part 1/08.92; silver-colored | www.wago.com/216-144 |
|  | Item no.: 216-201 Ferrule; Sleeve for 0.5 mm ² / 20 AWG; insulated; electro-tin plated; white | www.wago.com/216-201 |
|  | Item no.: 216-223 Ferrule; Sleeve for 1 mm ² / AWG 18; insulated; electro-tin plated; red | www.wago.com/216-223 |
|  | Item no.: 216-241 Ferrule; Sleeve for 0.5 mm ² / 20 AWG; insulated; electro-tin plated; electrolytic copper; gastight crimped; acc. to DIN 46228, Part 4/09.90; white | www.wago.com/216-241 |
|  | Item no.: 216-242 Ferrule; Sleeve for 0.75 mm ² / 18 AWG; insulated; electro-tin plated; electrolytic copper; gastight crimped; acc. to DIN 46228, Part 4/09.90; gray | www.wago.com/216-242 |
|  | Item no.: 216-222 Ferrule; Sleeve for 0.75 mm ² / 18 AWG; insulated; electro-tin plated; gray | www.wago.com/216-222 |

Subject to changes. Please also observe the further product documentation!



| | | |
|---|--|--|
|  | Item no.: 216-221 Ferrule; Sleeve for 0.5 mm ² / 20 AWG; insulated; electro-tin plated; white | www.wago.com/216-221 |
|  | Item no.: 216-224 Ferrule; Sleeve for 1.5 mm ² / AWG 16; insulated; electro-tin plated; black | www.wago.com/216-224 |
|  | Item no.: 216-243 Ferrule; Sleeve for 1 mm ² / AWG 18; insulated; electro-tin plated; electrolytic copper; gastight crimped; acc. to DIN 46228, Part 4/09.90; red | www.wago.com/216-243 |
|  | Item no.: 216-244 Ferrule; Sleeve for 1.5 mm ² / AWG 16; insulated; electro-tin plated; electrolytic copper; gastight crimped; acc. to DIN 46228, Part 4/09.90; black | www.wago.com/216-244 |
|  | Item no.: 216-263 Ferrule; Sleeve for 1 mm ² / AWG 18; insulated; electro-tin plated; electrolytic copper; gastight crimped; acc. to DIN 46228, Part 4/09.90; red | www.wago.com/216-263 |
|  | Item no.: 216-264 Ferrule; Sleeve for 1.5 mm ² / AWG 16; insulated; electro-tin plated; electrolytic copper; gastight crimped; acc. to DIN 46228, Part 4/09.90; black | www.wago.com/216-264 |
|  | Item no.: 216-262 Ferrule; Sleeve for 0.75 mm ² / 18 AWG; insulated; electro-tin plated; electrolytic copper; gastight crimped; acc. to DIN 46228, Part 4/09.90; gray | www.wago.com/216-262 |
|  | Item no.: 216-301 Ferrule; Sleeve for 0.25 mm ² / AWG 24; insulated; electro-tin plated; yellow | www.wago.com/216-301 |
|  | Item no.: 216-321 Ferrule; Sleeve for 0.25 mm ² / AWG 24; insulated; electro-tin plated; yellow | www.wago.com/216-321 |
|  | Item no.: 216-322 Ferrule; Sleeve for 0.34 mm ² / 22 AWG; insulated; electro-tin plated; light turquoise | www.wago.com/216-322 |
|  | Item no.: 216-302 Ferrule; Sleeve for 0.34 mm ² / 22 AWG; insulated; electro-tin plated; light turquoise | www.wago.com/216-302 |

Downloads

Documentation

Additional Information

| | | | |
|------------------------|------------|--------|----------|
| Technical Section | 2019 Apr 3 | pdf | Download |
| Technical explanations | | 2.1 MB | |

CAD/CAE-Data

CAD data

| | | |
|------------------------------|-----|----------|
| 2D/3D Models 231-203/037-000 | URL | Download |
|------------------------------|-----|----------|

CAE data

Subject to changes. Please also observe the further product documentation!

WAGO GmbH & Co. KG
 Hansastr. 27
 32423 Minden
 Phone: +49571 887-0 | Fax: +49571 887-169
 Email: info.de@wago.com | Web: www.wago.com

Do you have any questions about our products?
 We are always happy to take your call at +49 (571) 887-44222.

| | | |
|--|---------------------|--------------------------|
| EPLAN Data Portal 231-203/037-000 | URL | Download |
| ZUKEN Portal 231-203/037-000 | URL | Download |
| EPLAN Data Portal 231-203/037-000 | URL | Download |
| Asset Administration Shell | | |
| Asset Administration Shell 231-203/037-000 | URL | Download |

Environmental Product Compliance

Compliance Search

| | | |
|---|---------------------|--------------------------|
| Environmental Product Compliance 231-203/037-000 1-conductor female connector; CAGE CLAMP®; 2.5 mm ² ; Pin spacing 7.5 mm; 3-pole; Lateral locking levers; 2,50 mm ² ; gray | URL | Download |
|---|---------------------|--------------------------|

Installation Notes

Conductor termination

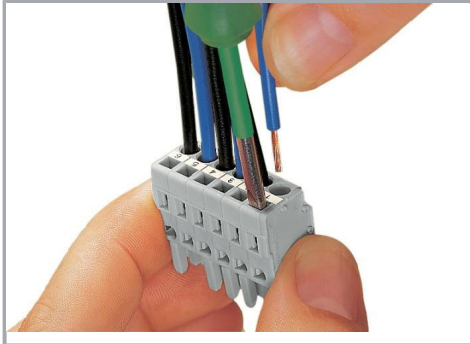

Inserting a conductor via 3.5 mm screwdriver – CAGE CLAMP® actuation parallel to conductor entry.

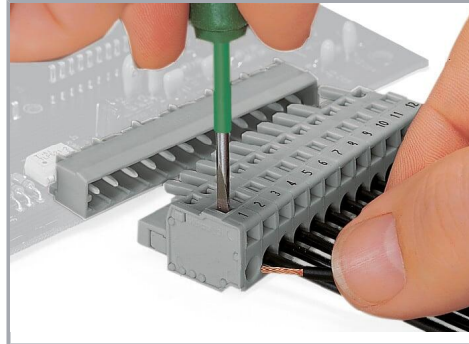

Inserting a conductor via 3.5 mm screwdriver – CAGE CLAMP® actuation perpendicular to conductor entry.

Subject to changes. Please also observe the further product documentation!



Inserting a conductor into CAGE CLAMP® unit via operating tool (231-291).



Inserting a conductor via operating tool.

Coding



Coding a female connector by removing coding finger(s).

Testing

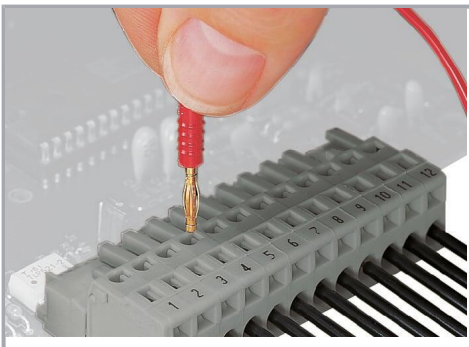

Testing – female connector with CAGE CLAMP®
Integrated test ports for testing perpendicular to conductor entry via 2 or 2.3 mm Ø test plug

Installation

Subject to changes. Please also observe the further product documentation!



Male connector with strain relief plate



Strain relief housing shown with a male connector equipped with CAGE CLAMP®

Marking



Labeling via direct marking or self-adhesive strips.

Product family

MCS MIDI Classic

[Show all products from the family](#)

Subject to changes. Please also observe the further product documentation!