

Data sheet | Item number: 769-638/003-000

THT male header; 1.0 x 1.0 mm solder pin; straight; clamping collar; Pin spacing 5 mm; 8-pole; gray

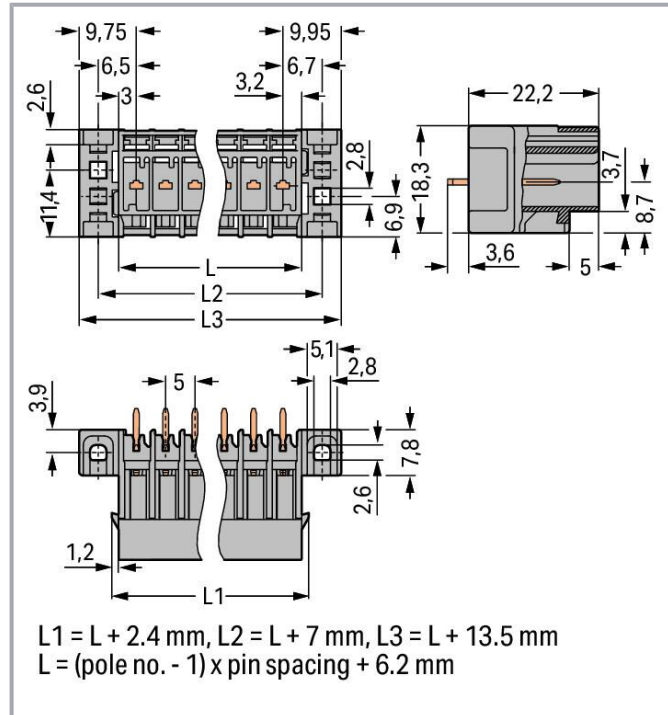

www.wago.com/769-638/003-000

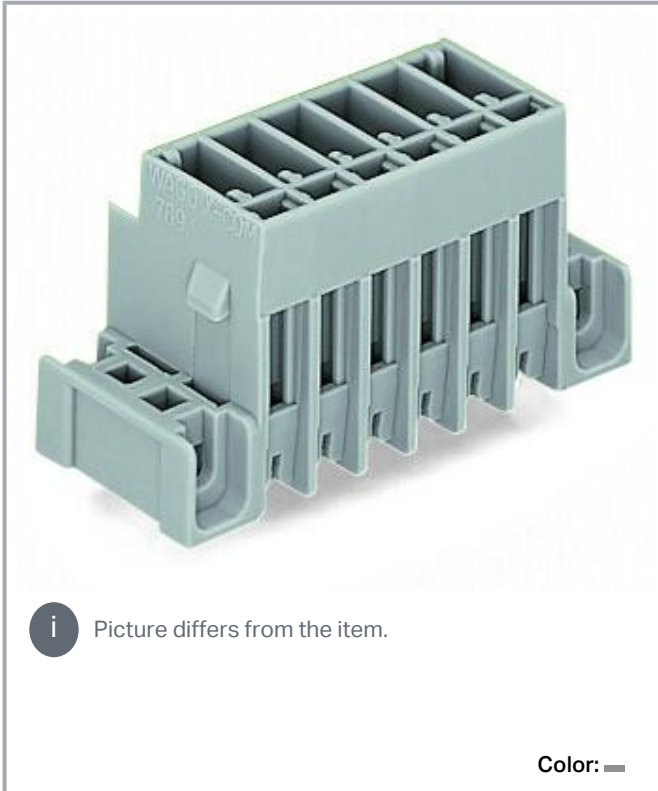

Data

Electrical data

Ratings per IEC/EN

Nominal voltage (III/3)	250 V
Rated impulse voltage (III/3)	4 kV
Rated voltage (III/2)	500 V
Rated impulse voltage (III/2)	4 kV
Rated current	32 A
Legend (ratings)	(III / 3) $\hat{=}$ Overvoltage category III / Pollution degree 3

Subject to changes. Please also observe the further product documentation!

WAGO GmbH & Co. KG
Hansastr. 27
32423 Minden
Phone: +49571 887-0 | Fax: +49571 887-169
Email: info.de@wago.com | Web: www.wago.com

Do you have any questions about our products?
We are always happy to take your call at +49 (571) 887-44222.



Connection data

Total number of potentials	8
Number of levels	1
Preceding contacts	No

Connection 1

Pole number	8
-------------	---

Physical data

Pin spacing	5 mm / 0.197 inches
Width	54.7 mm / 2.154 inches
Height from the surface	22.2 mm / 0.874 inches
Depth	18.3 mm / 0.72 inches

Mechanical Data

Variable coding	Yes
Mounting type	Mounting flange
Anti-rotation protection	Yes

Plug-in connection

Contact type (pluggable connector)	Male connector/plug
Connector (connection type)	for PCB
Mismating protection	No
Plugging without loss of pin spacing	No
Mating direction to the PCB	90 °

PCB contact

PCB contact	THT
-------------	-----

Material data

Note (material data)	Information on material specifications can be found here
Color	gray
Material group	I

Subject to changes. Please also observe the further product documentation!

Insulation material	Polyamide (PA66)
Flammability class per UL94	V0
Fire load	0.294 MJ
Weight	9 g

Environmental requirements

Processing temperature	-35 ... +85 °C
Continuous operating temperature	-60 ... +105 °C

Commercial data



Product Group	18 (X-COM-System)
eCl@ss 10.0	27-44-04-02
eCl@ss 9.0	27-44-04-02
ETIM 8.0	EC002637
ETIM 7.0	EC002637
ECCN	NO DATA
PU (SPU)	25 pcs
Packaging type	box
Country of origin	PL
GTIN	4044918270724
Customs tariff number	85366930000

Environmental Product Compliance

RoHS Compliance Status	Compliant, No Exemption
------------------------	-------------------------

Approvals / Certificates



General approvals

Logo	Approval	Additional Approval Text	Certificate name
	CCA DEKRA Certification B.V.	EN 61984	2190419.02
	CCA DEKRA Certification B.V.	EN 60947	NTR NL-7626
	CCA	IEC 61984	NL-47799

Subject to changes. Please also observe the further product documentation!

	DEKRA Certification B.V.		/A1
	CSA CSA Group	C22.2	1101144
	KEMA/KEUR DEKRA Certification B.V.	EN 60947	2190419.01
	UL Underwriters Laboratories Inc.	UL 1977	E 45171
	UR Underwriters Laboratories Inc.	UL 1059	E45172

Declarations of conformity and manufacturer's declarations

Logo	Approval	Additional Approval Text	Certificate name
	EU-Declaration of Conformity WAGO GmbH & Co. KG	-	-
	UK-Declaration of Conformity WAGO GmbH & Co. KG	-	-

Approvals for marine applications

Logo	Approval	Additional Approval Text	Certificate name
	DNV GL Det Norske Veritas, Germanischer Lloyd	-	TAE00001V2

Subject to changes. Please also observe the further product documentation!

Counterpart

Item no.769-108/021-000

1-conductor female connector; CAGE CLAMP®; 4 mm²; Pin spacing 5 mm; 8-pole; coding finger; Lateral locking levers; 4,00 mm²; gray

www.wago.com/769-108/021-000

Item no.769-128

2-conductor female connector; CAGE CLAMP®; 4 mm²; Pin spacing 5 mm; 8-pole; coding finger; 4,00 mm²; gray

www.wago.com/769-128

Item no.769-108

1-conductor female connector; CAGE CLAMP®; 4 mm²; Pin spacing 5 mm; 8-pole; coding finger; 4,00 mm²; gray

www.wago.com/769-108

Optional accessories

Coding

Coding

Item no.: 769-435

Coding pin; for coding of female plugs; for carrier terminal blocks / male connectors; orange

www.wago.com/769-435

Marking accessories

Marking strip

Item no.: 210-831

Marking strips; on reel; 2.3 mm wide; plain; Self-adhesive; white

www.wago.com/210-831

Item no.: 210-833

Marking strips; 25 m on roll; 6 mm wide; plain; Self-adhesive; white

www.wago.com/210-833

Item no.: 210-834

Marking strips; on reel; 5 mm wide; plain; Self-adhesive; white

www.wago.com/210-834

Item no.: 210-832

Marking strips; on reel; 3 mm wide; plain; Self-adhesive; white

www.wago.com/210-832

Downloads

Documentation

Bid Text

769-638/003-000

2019 Feb 19

xml

Download

X81 - Datei

3.1 kB

Subject to changes. Please also observe the further product documentation!

WAGO GmbH & Co. KG

Hansastr. 27

32423 Minden

Phone: +49571 887-0 | Fax: +49571 887-169

Email: info.de@wago.com | Web: www.wago.com

Do you have any questions about our products?

We are always happy to take your call at +49 (571) 887-44222.



769-638/003-000

2017 Oct 4

doc
25.6 kB

Download

doc - Datei

Additional Information

pdf
2.3 MB

Download

CAD/CAE-Data

CAD data

2D/3D Models 769-638/003-000

URL

Download

PCB Design

Symbol and Footprint via Ultra Librarian 769-638/003-000

URL

Download

CAX data for your PCB design, consisting of "schematic symbols and PCB footprints", allow easy integration of the WAGO component into your development environment.

Supported formats:

- Accel EDA 14 & 15
- Altair
- Altium 6 to current version
- Autodesk Fusion 360
- Cadence Allegro
- DesignSpark
- Eagle Libraries
- KiCad
- Mentor Graphics
- BoardStation
- Mentor Graphics Design Architect
- Mentor Graphics Design
- Expedition 99 and 2000
- OrCAD 9.X PCB and Capture
- PADS PowerPCB 3, 3.5, 4.X, and 5.X
- PADS PowerPCB and PowerLogic 3.0
- PCAD 2000, 2001, 2002, 2004, and 2006
- Pulsonix 8.5 or newer
- STL

—
Subject to changes. Please also observe the further product documentation!

WAGO GmbH & Co. KG

Hansastr. 27

32423 Minden

Phone: +49571 887-0 | Fax: +49571 887-169

Email: info.de@wago.com | Web: www.wago.com

Do you have any questions about our products?

We are always happy to take your call at +49 (571) 887-44222.



- 3D STEP
- TARGET 3001!
- View Logic ViewDraw
- Quadcept
- Zuken CadStar 3 and 4
- Zuken CR-5000 and CR-8000
- Zuken eCADSTAR 2020 and 2021Zuken CR-5000 and CR-8000

PCB Component Libraries (EDA), PCB CAD Library Ultra Librarian

Symbol and Footprint via SamacSys 769-638/003-000

URL

Download

CAX data for your PCB design, consisting of "schematic symbols and PCB footprints", allow easy integration of the WAGO component into your development environment.

Supported formats:

- 3D (stp)
- Altium
- CADSTAR
- Capture
- CircuitStudio
- CR-5000
- CR-8000
- DEHDL
- DesignSpark PCB
- DesignSpark PCB PRO
- DipTrace
- EAGLE
- Easy-PC
- EasyEDA
- eCADSTAR
- KiCad
- OrCAD_Allegro16
- PADS
- Proteus
- Pulsonix
- Quadcept
- SOLIDWORKS PCB
- TARGET 3001!

—
Subject to changes. Please also observe the further product documentation!

- xDX Designer
- Xpedition

PCB Component Libraries (EDA), PCB CAD Library SamacSys Electronic Component Search Engine

CAE data

ZUKEN Portal 769-638/003-000	URL	Download
------------------------------	---------------------	--------------------------

Asset Administration Shell

Asset Administration Shell 769-638/003-000	URL	Download
--	---------------------	--------------------------

Environmental Product Compliance

Compliance Search

Environmental Product Compliance 769-638/003-000	URL	Download
--	---------------------	--------------------------

THT male header; 1.0 x 1.0 mm solder pin; straight; clamping collar; Pin spacing 5 mm; 8-pole; gray

Installation Notes

Application

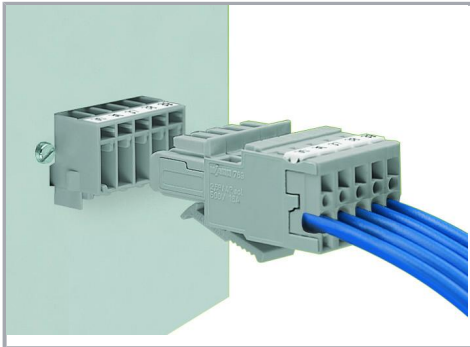

Male header with mounting flanges
1-conductor female plug with bottom-mount locking levers

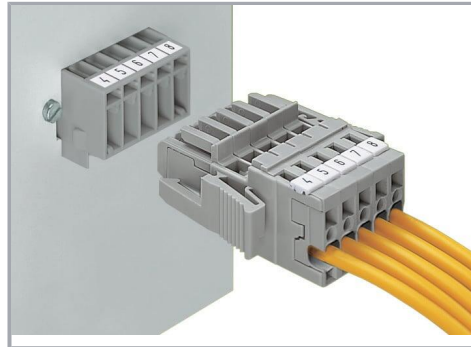

Male header with mounting flanges
1-conductor female plug with lateral locking levers

Product family

X-COM

[Show all products from the family](#)

Subject to changes. Please also observe the further product documentation!