

Data sheet | Item number: 770-734

Snap-in plug; 4-pole; Cod. A; 4,00 mm²; white

www.wago.com/770-734

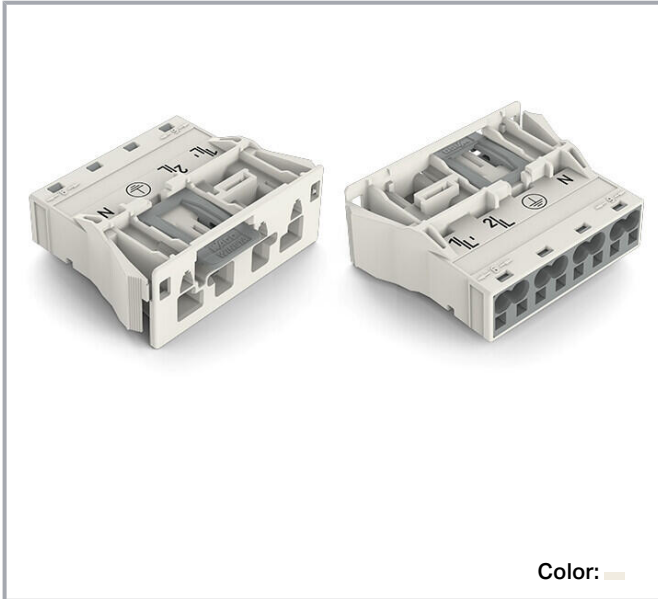

Color: 

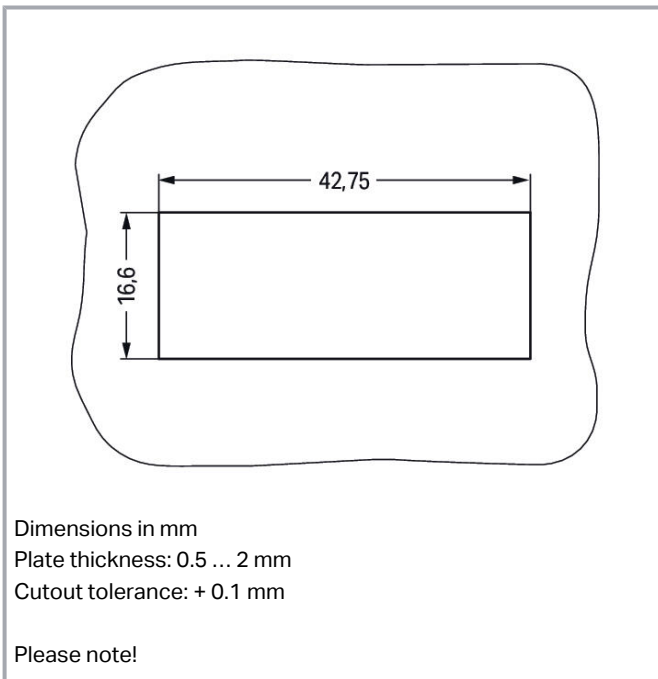
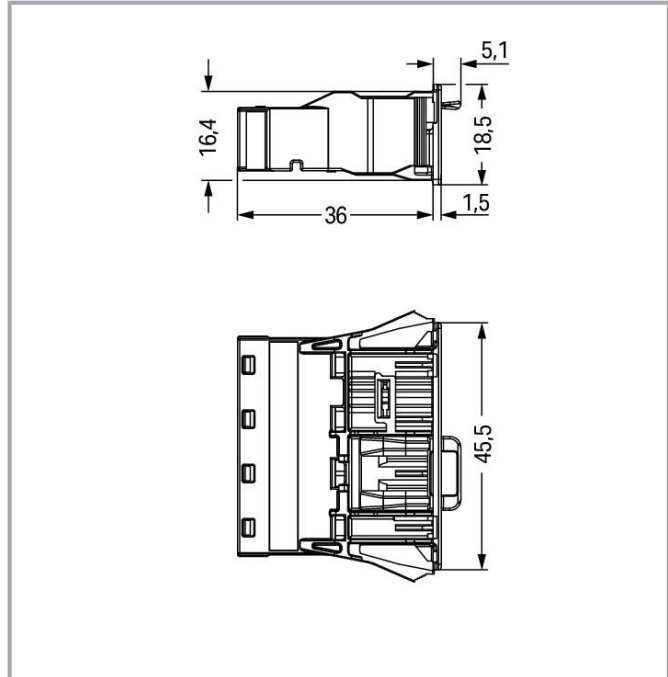

Dimensions in mm

Plate thickness: 0.5 ... 2 mm

Cutout tolerance: + 0.1 mm

Please note!

Subject to changes. Please also observe the further product documentation!

WAGO GmbH & Co. KG

Hansastr. 27

32423 Minden

Phone: +49571 887-0 | Fax: +49571 887-169

Email: info.de@wago.com | Web: www.wago.com

Do you have any questions about our products?

We are always happy to take your call at +49 (571) 887-44222.



Item description

Male connector/plug *WINSTA*® MIDI with protection against mismatching

The *WINSTA*® MIDI male connector/plug 4-pole allows installation of fine-stranded and solid conductors. Our pluggable installation connectors with spring pressure connection technology function without screw connections. They allow fast, efficient, error-free installation in numerous possible uses. For greater security in electrical installations, the pluggable installation connector is provided with mechanical protection against mismatching. The pluggable installation connector offers protection against contact with live components in accordance with protection type IP20 (When mated: IP2xC (These compact connectors are not designed for use in open, easily accessible areas!)). Thanks to the color coding and mechanical A coding of *WINSTA*® MIDI pluggable installation connectors, you can clearly distinguish different circuits. This pluggable installation connector can be used for a voltage load of up to 25 A. Therefore, it can also be used for high power loads. *WINSTA*® MIDI with Push-in CAGE CLAMP® spring pressure connection technology is used in a broad range of individual products you can use for quick, easy and maximally flexible electrical installation.

Lower costs through fast commissioning and elimination of service expenses – solutions from *WINSTA*® MIDI

The *WINSTA*® Pluggable Connection System is ideally tailored to the very strict requirements of building installation. It makes electrical installation pluggable, and consequently faster, even more reliable, and error-free. Using this pre-assembled system decreases time spent on assembly and installation errors at the construction site. Now you can also reduce installation expenses without compromising quality and safety: with locking lever reduces the need for servicing and prevents unnecessary downtime.

-
- protection against mismatching eliminates errors
- pre-assembled versions
- for any mains application
- ready for immediate use
- convenient installation and commissioning

Data

Notes

| | |
|------|--|
| Note | <p>The snap-in connectors must be relieved of tensile and transverse forces.</p> <p>A surface finish can influence the edge radius of the cutouts. This may affect the snap-in socket fit, so ensure an adequate fit before use. In addition, the punched edge should be on the inside for punched cutouts.</p> <p>The wings of the snap-in connectors must not be mechanically stressed for a long period before use (e.g., due to a pre-locking position).</p> |
|------|--|

Subject to changes. Please also observe the further product documentation!



Electrical data

Ratings per IEC/EN

| | |
|-------------------------------|---|
| Ratings per | IEC/EN 60664-1 |
| Nominal voltage (III/3) | 400 V |
| Rated impulse voltage (III/3) | 6 kV |
| Rated current | 25 A |
| Legend (ratings) | (III / 3) $\hat{=}$ Overvoltage category III / Pollution degree 3 |

Ratings per UL 1977

| | |
|-------------------------|--|
| Note for the US market | Some versions may also be used for current interruption in accordance with the UL certificate in select applications with currents below 16 A and voltages up to 600 V. For further information, please contact your local sales office. |
| Rated voltage (UL 1977) | 600 V |
| Rated current UL 1977 | 23 A |

General information

| | |
|----------------------------|--|
| Note on contact resistance | approx. 1 m Ω of contact resistance approx. 0.25 m Ω contact transition plug/socket |
|----------------------------|--|

Connection data

| | |
|----------------------------|----------------------|
| Connection points | 8 |
| Total number of potentials | 4 |
| PE function | Preceding PE contact |

Connection 1

| | |
|---|--|
| Connection technology | Push-in CAGE CLAMP [®] |
| Actuation type | Operating tool Push-in |
| Nominal cross-section | 4 mm ² / 12 AWG |
| Solid conductor | 0.5 ... 4 mm ² / 20 ... 12 AWG |
| Solid conductor; push-in termination | 1.5 ... 4 mm ² / 16 ... 12 AWG |
| Stranded conductor | 0.5 ... 2.5 mm ² / 20 ... 14 AWG |
| Fine-stranded conductor | 0.5 ... 4 mm ² / 20 ... 12 AWG |
| Fine-stranded conductor; with insulated ferrule | 0.25 ... 1.5 mm ² / 20 ... 16 AWG |
| Fine-stranded conductor; with uninsulated ferrule | 0.25 ... 2.5 mm ² / 20 ... 14 AWG |

Subject to changes. Please also observe the further product documentation!



| | |
|--|------------------------------|
| Fine-stranded conductor; with ferrule; push-in termination | 1.5 mm ² / 16 AWG |
| Strip length | 9 mm / 0.35 inches |
| Pole number | 4 |
| Conductor entry direction to mating direction | 0° |

Physical data

| | |
|-------------|------------------------|
| Pin spacing | 10 mm / 0.394 inches |
| Width | 45.5 mm / 1.791 inches |
| Height | 18.5 mm / 0.728 inches |
| Depth | 41.1 mm / 1.618 inches |

Mechanical Data

| | |
|---|---|
| Application | General mains applications |
| Coding | A |
| Variable coding | Yes |
| Marking | 1/L' 2/L' \perp N |
| Potential marking | 1/L' 2/L' \perp N |
| Mating force of a plug-in connection | approx. 20 ... 70 N (depending on pole number) |
| Retention force of a plug-in connection | Locked: > 80 N |
| Unmating force of a plug-in connection | Unlocked: approx. 20 ... 70 N (depending on pole number) |
| Number of mating cycles | 200, without resistive load |
| Housing sheet thickness | 0.5 ... 2 mm / 0.02 ... 0.079 inches |
| Mounting type | Snap-in flange |
| Protection type | IP20; When mated: IP2xC (These compact connectors are not designed for use in open, easily accessible areas!) |

Plug-in connection

| | |
|------------------------------------|--|
| Contact type (pluggable connector) | Male connector/plug |
| Connector (connection type) | for conductor |
| Mismating protection | Yes |
| Note on mismating protection | All <i>WINSTA</i> [®] components are 100% protected against mismating when: a.) plugging different numbers of poles b.) plugging while rotated 180 c.) plugging while laterally staggered d.) plugging one pole |
| Locking lever | yes |
| Locking of plug-in connection | locking lever |

Subject to changes. Please also observe the further product documentation!



Note on locking system

All connectors for mounted installations (snap-in versions for lighting fixtures or devices, all types of PCB and distribution connectors) are factory-equipped with locking levers to ensure plugs and sockets are securely locked. Additional locking levers are only required for flying leads (plug/socket).

Material data

Note (material data)

Information on material specifications can be found here

| | |
|-----------------------------|---|
| Color | white |
| Insulation material | Polyamide (PA66) |
| Flammability class per UL94 | V0 |
| Clamping spring material | Chrome-nickel spring steel (CrNi) |
| Contact material | Copper or copper alloy; surface-treated |
| Contact plating | Tin |
| Fire load | 0.347 MJ |
| Weight | 15.6 g |

Environmental requirements

| | |
|--|--|
| Processing temperature | -5 ... +40 °C |
| Continuous operating temperature | -35 ... +85 °C |
| Note on continuous operating temperature | Insulating parts for temperatures ≤ 105 °C |

Commercial data

| | |
|-----------------------|---------------|
| Product Group | 20 (Winsta) |
| eCl@ss 10.0 | 27-44-06-02 |
| eCl@ss 9.0 | 27-44-06-02 |
| ETIM 8.0 | EC002566 |
| ETIM 7.0 | EC002566 |
| ECCN | NO DATA |
| PU (SPU) | 100 pcs |
| Packaging type | box |
| Country of origin | DE |
| GTIN | 4044918254793 |
| Customs tariff number | 85366990990 |

Subject to changes. Please also observe the further product documentation!

WAGO GmbH & Co. KG
 Hansastr. 27
 32423 Minden
 Phone: +49571 887-0 | Fax: +49571 887-169
 Email: info.de@wago.com | Web: www.wago.com

Do you have any questions about our products?
 We are always happy to take your call at +49 (571) 887-44222.



Environmental Product Compliance

RoHS Compliance Status

Compliant, No Exemption

Approvals / Certificates



General approvals

| Logo | Approval | Additional Approval Text | Certificate name |
|---|---|--------------------------|------------------|
|  | CCA DEKRA Certification B.V. | EN 61535 | 71-123228 |
| | CCA DEKRA Certification B.V. | IEC 61535 | NL -84761 |
|  | cURus Underwriters Laboratories Inc. | UL 1977 | E45171 |
|  | cURus Underwriters Laboratories Inc. | UL 1059 | E 45172 |

Declarations of conformity and manufacturer's declarations

| Logo | Approval | Additional Approval Text | Certificate name |
|--|--|--------------------------|------------------|
|  | EU-Declaration of Conformity WAGO GmbH & Co. KG | - | - |

Approvals for marine applications

| Logo | Approval | Additional Approval Text | Certificate name |
|--|--|--------------------------|------------------|
|  | ABS American Bureau of Shipping | - | 19-HG1868589-PDA |
|  | DNV GL Det Norske Veritas, Germanischer Lloyd | - | TAE00001Z6 |

Subject to changes. Please also observe the further product documentation!

WAGO GmbH & Co. KG
 Hansastr. 27
 32423 Minden
 Phone: +49571 887-0 | Fax: +49571 887-169
 Email: info.de@wago.com | Web: www.wago.com

Do you have any questions about our products?
 We are always happy to take your call at +49 (571) 887-44222.



LR
Lloyds Register

IEC 61984

LR22429487TA

Counterpart



Item no.770-224
Socket; 4-pole; Cod. A; 4,00 mm²; white

www.wago.com/770-224

Item no.771-9994/006-102
pre-assembled interconnecting cable; Eca; Socket/plug; 4-pole; Cod. A; H05VV-F 4G 1.5 mm²; 1 m; 1,50 mm²; white

www.wago.com/771-9994/006-102

Item no.771-9994/106-102
pre-assembled connecting cable; Eca; Socket/open-ended; 4-pole; Cod. A; H05VV-F 4G 1.5 mm²; 1 m; 1,50 mm²; white

www.wago.com/771-9994/106-102

Item no.770-124
Socket; with strain relief housing; 4-pole; Cod. A; 4,00 mm²; white

www.wago.com/770-124

Optional accessories

Tool

Operating tool



Item no.: 210-719
Operating tool; Blade: 2.5 x 0.4 mm; with a partially insulated shaft

www.wago.com/210-719

Cover

Cover



Item no.: 770-694
Lockout cap; 4-pole; for cutouts; Plastic; white

www.wago.com/770-694

Item no.: 770-644
Lockout cap; 4-pole; for cutouts; Plastic; black

www.wago.com/770-644

Item no.: 770-360
Lockout cap; for plugs; 5-pole; separable; yellow

www.wago.com/770-360

Downloads

Documentation

Bid Text

770-734

Subject to changes. Please also observe the further product documentation!

WAGO GmbH & Co. KG
Hansastr. 27
32423 Minden
Phone: +49571 887-0 | Fax: +49571 887-169
Email: info.de@wago.com | Web: www.wago.com

Do you have any questions about our products?
We are always happy to take your call at +49 (571) 887-44222.



| | | | |
|------------------------|-------------|----------------|----------|
| X81 - Datei | 2019 Feb 19 | xml 3.0 kB | Download |
| 770-734 doc - Datei | 2015 Jun 8 | doc 23.6 kB | Download |

CAD/CAE-Data

CAD data

| | | | |
|----------------------|--|-----|----------|
| 2D/3D Models 770-734 | | URL | Download |
|----------------------|--|-----|----------|

CAE data

| | | | |
|---------------------------|--|-----|----------|
| EPLAN Data Portal 770-734 | | URL | Download |
|---------------------------|--|-----|----------|

| | | | |
|------------------------|--|-----|----------|
| WSCAD Universe 770-734 | | URL | Download |
|------------------------|--|-----|----------|

| | | | |
|----------------------|--|-----|----------|
| ZUKEN Portal 770-734 | | URL | Download |
|----------------------|--|-----|----------|

Asset Administration Shell

| | | | |
|------------------------------------|--|-----|----------|
| Asset Administration Shell 770-734 | | URL | Download |
|------------------------------------|--|-----|----------|

Environmental Product Compliance

Compliance Search

| | | | |
|--|--|-----|----------|
| Environmental Product Compliance 770-734 Snap-in plug; 4-pole; Cod. A; 4,00 mm ² ; white | | URL | Download |
|--|--|-----|----------|

Installation Notes

Conductor termination

Subject to changes. Please also observe the further product documentation!

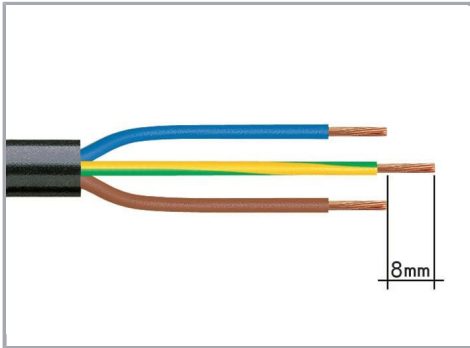

1. Strip length, outer insulation = 35 mm (2-pole), 55 mm (3- to 5-pole)
2. Strip length = 9 mm
3. Extended ground conductor = 8 mm

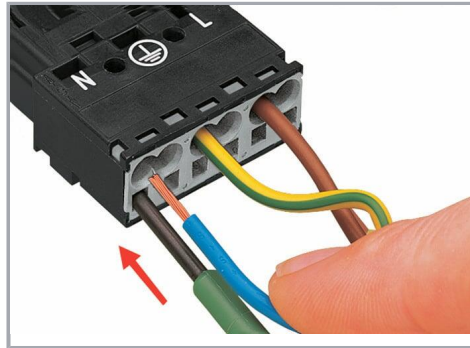

To terminate fine-stranded conductors, open the clamping unit via screwdriver (2.5 mm blade width) and insert a stripped conductor until it hits the backstop.

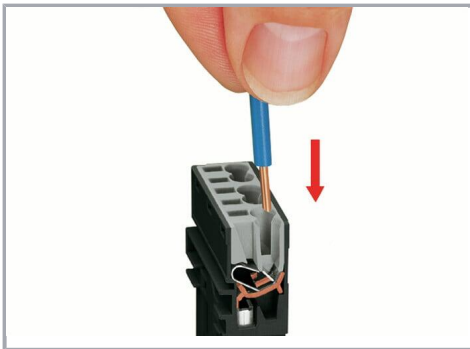

Insert the stripped solid conductor until it hits the backstop.

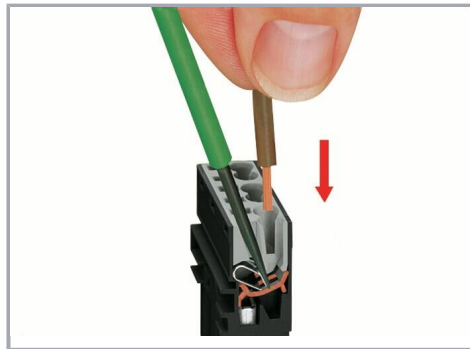

To terminate fine-stranded conductors, open the clamping unit via screwdriver (2.5 mm blade width) and insert a stripped conductor until it hits the backstop.

Conductor removal

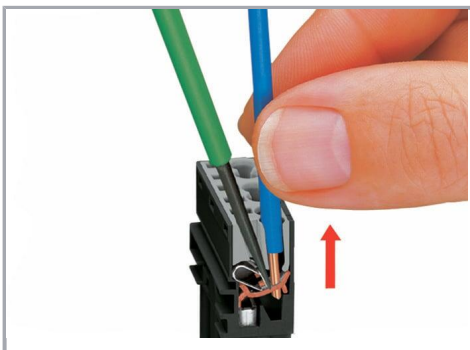

To remove the conductor, actuate the clamp via screwdriver (2.5 mm blade width) and pull out the conductor.

Subject to changes. Please also observe the further product documentation!

Data sheet | Item number: 770-734

www.wago.com/770-734

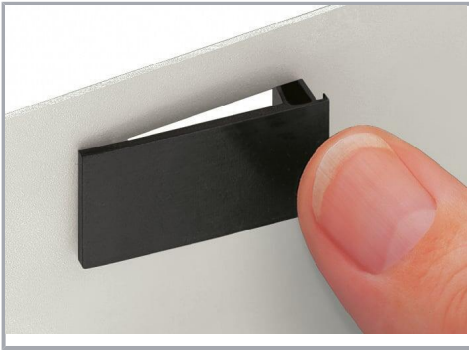

Seal unused cutout with lockout cap.

Product family

WINSTA® MIDI

[Show all products from the family](#)

Subject to changes. Please also observe the further product documentation!

WAGO GmbH & Co. KG
Hansastr. 27
32423 Minden
Phone: +49571 887-0 | Fax: +49571 887-169
Email: info.de@wago.com | Web: www.wago.com

Do you have any questions about our products?
We are always happy to take your call at +49 (571) 887-44222.