

Data sheet | Item number: 734-110/008-000

1-conductor female connector; CAGE CLAMP®; 1.5 mm²; Pin spacing 3.5 mm; 10-pole; 100% protected against mismatching; Snap-in mounting feet; 1,50 mm²; light gray

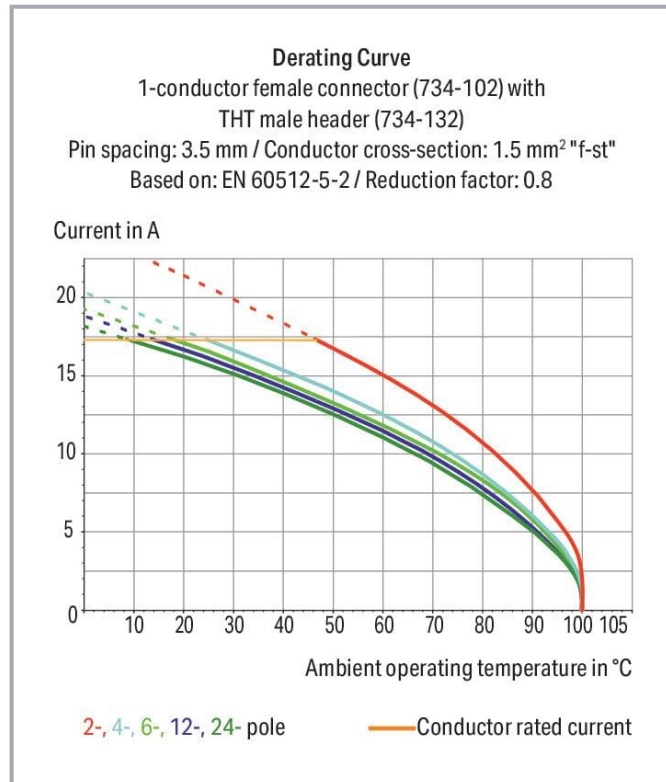

www.wago.com/734-110/008-000

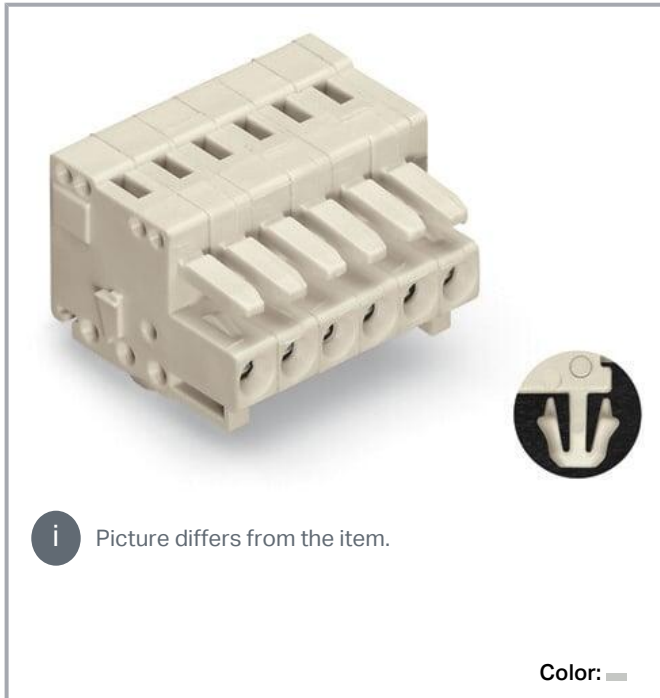

Subject to changes. Please also observe the further product documentation!

WAGO GmbH & Co. KG
Hansastr. 27
32423 Minden
Phone: +49571 887-0 | Fax: +49571 887-169
Email: info.de@wago.com | Web: www.wago.com

Do you have any questions about our products?
We are always happy to take your call at +49 (571) 887-44222.

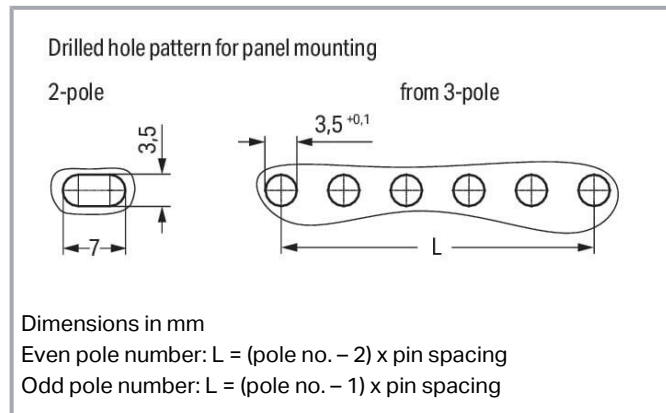
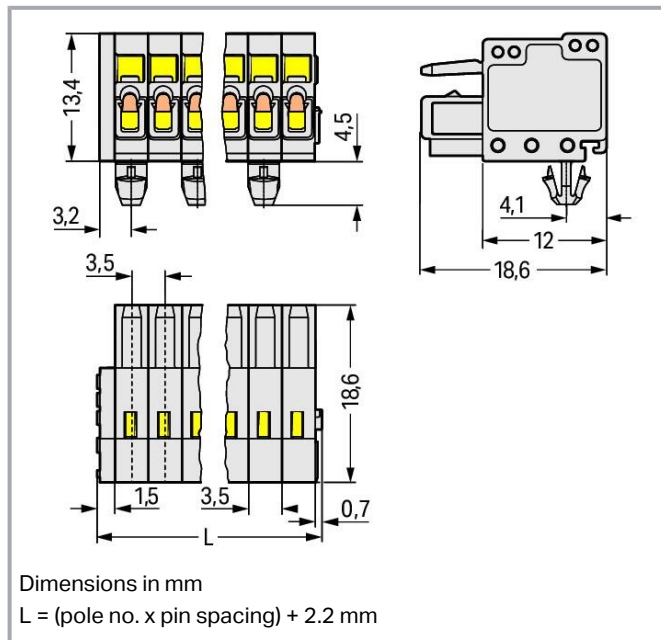

Item description

- Universal connection for all conductor types
- Easy cable pre-assembly and on-unit wiring via vertical and horizontal CAGE CLAMP® actuation
- Strain relief plates and housings for field assembly
- 100% protected against mismatching
- Coding option available

Data

Notes

Safety information

The *MCS – MULTI CONNECTION SYSTEM* includes connectors without breaking capacity in accordance with DIN EN 61984. When used as intended, these connectors must not be connected /disconnected when live or under load. When used as intended, these connectors must not be connected/disconnected when live or under load. The circuit design should ensure header pins, which can be touched, are not live when unmated.

Variants:

Other pole numbers
 Gold-plated or partially gold-plated contact surfaces
 Other versions (or variants) can be requested from WAGO Sales or configured at <https://configurator.wago.com/>.

Electrical data

Subject to changes. Please also observe the further product documentation!



Ratings per IEC/EN

Ratings per	IEC/EN 60664-1
Nominal voltage (III/3)	160 V
Rated impulse voltage (III/3)	2.5 kV
Rated voltage (III/2)	160 V
Rated impulse voltage (III/2)	2.5 kV
Nominal voltage (II/2)	320 V
Rated surge voltage (II/2)	2.5 kV
Rated current	10 A
Legend (ratings)	(III / 2) $\hat{=}$ Overvoltage category III / Pollution degree 2

Ratings per UL

Approvals per	UL 1059
Rated voltage UL (Use Group B)	300 V
Rated current UL (Use Group B)	10 A
Rated voltage UL (Use Group D)	300 V
Rated current UL (Use Group D)	10 A

Ratings per CSA

Approvals per	CSA
Rated voltage CSA (Use Group B)	300 V
Rated current CSA (Use Group B)	10 A
Rated voltage CSA (Use Group D)	300 V
Rated current CSA (Use Group D)	10 A

Connection data

Connection points	10
Total number of potentials	10
Number of connection types	1
Number of levels	1

Connection 1

Connection technology	CAGE CLAMP®
Actuation type	Operating tool
Actuation direction 1	Operation parallel to conductor entry

Subject to changes. Please also observe the further product documentation!



Actuation direction 2	Operation perpendicular to conductor entry
Solid conductor	0.08 ... 1.5 mm ² / 28 ... 14 AWG
Fine-stranded conductor	0.08 ... 1.5 mm ² / 28 ... 14 AWG
Fine-stranded conductor; with insulated ferrule	0.25 ... 1.5 mm ²
Fine-stranded conductor; with uninsulated ferrule	0.25 ... 1.5 mm ²
Note (conductor cross-section)	Terminating 1.5 mm ² conductors is possible; however insulation diameter does not allow clamping units to be terminated in a row.
Strip length	6 ... 7 mm / 0.24 ... 0.28 inches
Pole number	10
Conductor entry direction to mating direction	0°

Physical data

Pin spacing	3.5 mm / 0.138 inches
Width	37.2 mm / 1.465 inches
Height	18.9 mm / 0.744 inches
Height from the surface	13.4 mm / 0.528 inches
Depth	18.6 mm / 0.732 inches

Mechanical Data

Variable coding	Yes
Housing sheet thickness	0.6 ... 1.2 mm / 0.024 ... 0.047 inches
Mounting type	Snap-in foot
Mounting type	Panel mounting
Anti-rotation protection	Yes

Plug-in connection

Contact type (pluggable connector)	Female connector/socket
Connector (connection type)	for conductor
Mismating protection	Yes
Plugging without loss of pin spacing	No
Locking of plug-in connection	none

Material data

Note (material data)	Information on material specifications can be found here
Color	light gray

Subject to changes. Please also observe the further product documentation!



Material group	I
Insulation material	Polyamide (PA66)
Flammability class per UL94	V0
Clamping spring material	Chrome-nickel spring steel (CrNi)
Contact material	Copper alloy
Contact plating	Tin
Fire load	0.127 MJ
Weight	7.8 g

Environmental requirements

Limit temperature range	-60 ... +100 °C
Processing temperature	-35 ... +60 °C

Commercial data

Product Group	3 (Multi Conn. System)
eCl@ss 10.0	27-44-03-09
eCl@ss 9.0	27-44-03-09
ETIM 8.0	EC002638
ETIM 7.0	EC002638
ECCN	NO DATA
PU (SPU)	50 pcs
Packaging type	box
Country of origin	DE
GTIN	4045454930745
Customs tariff number	85366990990

Environmental Product Compliance

RoHS Compliance Status	Compliant, No Exemption
------------------------	-------------------------

Approvals / Certificates

General approvals

Logo	Approval	Additional Approval Text	Certificate name
	CB DEKRA Certification B.V.	EN 61984	NL-54190
	KEMA/KEUR DEKRA Certification B.V.	EN 61984	71- 105522

Subject to changes. Please also observe the further product documentation!





	UL Underwriters Laboratories Inc.	UL 1059	E45172
--	--------------------------------------	---------	--------

Declarations of conformity and manufacturer's declarations

Logo	Approval	Additional Approval Text	Certificate name
	Railway WAGO GmbH & Co. KG	-	Railway Ready

Approvals for marine applications

Logo	Approval	Additional Approval Text	Certificate name
	BV Bureau Veritas S.A.	IEC 60998	11915/DO BV
	DNV DNV GL SE	-	TAE000016Z

Counterpart



Item no.734-310
1-conductor male connector; CAGE CLAMP®; 1.5 mm²; Pin spacing 3.5 mm; 10-pole; 100% protected against mismatching; 1,50 mm²; light gray www.wago.com/734-310

Optional accessories

Testing and measuring

Testing accessories



Item no.: 735-500
WAGO Test pin; 1 mm Ø; 30 V AC / 60 V DC; CAT0; 1 A; 6 mm uninsulated; Test lead for soldering up to 0,5mm² www.wago.com/735-500

Ferrule

Subject to changes. Please also observe the further product documentation!

WAGO GmbH & Co. KG
Hansastr. 27
32423 Minden
Phone: +49571 887-0 | Fax: +49571 887-169
Email: info.de@wago.com | Web: www.wago.com

Do you have any questions about our products?
We are always happy to take your call at +49 (571) 887-44222.















Ferrule

1	Item no.: 216-101 Ferrule; Sleeve for 0.5 mm ² / AWG 22; uninsulated; electro-tin plated; silver-colored	www.wago.com/216-101
1	Item no.: 216-104 Ferrule; Sleeve for 1.5 mm ² / AWG 16; uninsulated; electro-tin plated; silver-colored	www.wago.com/216-104
1	Item no.: 216-102 Ferrule; Sleeve for 0.75 mm ² / AWG 20; uninsulated; electro-tin plated; silver-colored	www.wago.com/216-102
1	Item no.: 216-103 Ferrule; Sleeve for 1 mm ² / AWG 18; uninsulated; electro-tin plated	www.wago.com/216-103
1	Item no.: 216-123 Ferrule; Sleeve for 1 mm ² / AWG 18; uninsulated; electro-tin plated; silver-colored	www.wago.com/216-123
1	Item no.: 216-122 Ferrule; Sleeve for 0.75 mm ² / AWG 20; uninsulated; electro-tin plated; silver-colored	www.wago.com/216-122
1	Item no.: 216-124 Ferrule; Sleeve for 1.5 mm ² / AWG 16; uninsulated; electro-tin plated	www.wago.com/216-124
1	Item no.: 216-142 Ferrule; Sleeve for 0.75 mm ² / 18 AWG; uninsulated; electro-tin plated; electrolytic copper; gastight crimped; acc. to DIN 46228, Part 1/08.92	www.wago.com/216-142
1	Item no.: 216-132 Ferrule; Sleeve for 0.34 mm ² / AWG 24; uninsulated; electro-tin plated	www.wago.com/216-132
1	Item no.: 216-121 Ferrule; Sleeve for 0.5 mm ² / AWG 22; uninsulated; electro-tin plated; silver-colored	www.wago.com/216-121
1	Item no.: 216-143 Ferrule; Sleeve for 1 mm ² / AWG 18; uninsulated; electro-tin plated; electrolytic copper; gastight crimped; acc. to DIN 46228, Part 1/08.92	www.wago.com/216-143
1	Item no.: 216-131 Ferrule; Sleeve for 0.25 mm ² / AWG 24; uninsulated; electro-tin plated; silver-colored	www.wago.com/216-131
1	Item no.: 216-141 Ferrule; Sleeve for 0.5 mm ² / 20 AWG; uninsulated; electro-tin plated; electrolytic copper; gastight crimped; acc. to DIN 46228, Part 1/08.92	www.wago.com/216-141
1	Item no.: 216-152 Ferrule; Sleeve for 0.34 mm ² / AWG 24; uninsulated; electro-tin plated	www.wago.com/216-152
1	Item no.: 216-203 Ferrule; Sleeve for 1 mm ² / AWG 18; insulated; electro-tin plated; red	www.wago.com/216-203
1	Item no.: 216-202 Ferrule; Sleeve for 0.75 mm ² / 18 AWG; insulated; electro-tin plated; gray	www.wago.com/216-202
1	Item no.: 216-151 Ferrule; Sleeve for 0.25 mm ² / AWG 24; uninsulated; electro-tin plated	www.wago.com/216-151

Subject to changes. Please also observe the further product documentation!

	Item no.: 216-204 Ferrule; Sleeve for 1.5 mm ² / AWG 16; insulated; electro-tin plated; black	www.wago.com/216-204
	Item no.: 216-144 Ferrule; Sleeve for 1.5 mm ² / AWG 16; uninsulated; electro-tin plated; electrolytic copper; gastight crimped; acc. to DIN 46228, Part 1/08.92; silver-colored	www.wago.com/216-144
	Item no.: 216-201 Ferrule; Sleeve for 0.5 mm ² / 20 AWG; insulated; electro-tin plated; white	www.wago.com/216-201
	Item no.: 216-223 Ferrule; Sleeve for 1 mm ² / AWG 18; insulated; electro-tin plated; red	www.wago.com/216-223
	Item no.: 216-241 Ferrule; Sleeve for 0.5 mm ² / 20 AWG; insulated; electro-tin plated; electrolytic copper; gastight crimped; acc. to DIN 46228, Part 4/09.90; white	www.wago.com/216-241
	Item no.: 216-242 Ferrule; Sleeve for 0.75 mm ² / 18 AWG; insulated; electro-tin plated; electrolytic copper; gastight crimped; acc. to DIN 46228, Part 4/09.90; gray	www.wago.com/216-242
	Item no.: 216-222 Ferrule; Sleeve for 0.75 mm ² / 18 AWG; insulated; electro-tin plated; gray	www.wago.com/216-222
	Item no.: 216-221 Ferrule; Sleeve for 0.5 mm ² / 20 AWG; insulated; electro-tin plated; white	www.wago.com/216-221
	Item no.: 216-224 Ferrule; Sleeve for 1.5 mm ² / AWG 16; insulated; electro-tin plated; black	www.wago.com/216-224
	Item no.: 216-243 Ferrule; Sleeve for 1 mm ² / AWG 18; insulated; electro-tin plated; electrolytic copper; gastight crimped; acc. to DIN 46228, Part 4/09.90; red	www.wago.com/216-243
	Item no.: 216-244 Ferrule; Sleeve for 1.5 mm ² / AWG 16; insulated; electro-tin plated; electrolytic copper; gastight crimped; acc. to DIN 46228, Part 4/09.90; black	www.wago.com/216-244
	Item no.: 216-263 Ferrule; Sleeve for 1 mm ² / AWG 18; insulated; electro-tin plated; electrolytic copper; gastight crimped; acc. to DIN 46228, Part 4/09.90; red	www.wago.com/216-263
	Item no.: 216-264 Ferrule; Sleeve for 1.5 mm ² / AWG 16; insulated; electro-tin plated; electrolytic copper; gastight crimped; acc. to DIN 46228, Part 4/09.90; black	www.wago.com/216-264
	Item no.: 216-262 Ferrule; Sleeve for 0.75 mm ² / 18 AWG; insulated; electro-tin plated; electrolytic copper; gastight crimped; acc. to DIN 46228, Part 4/09.90; gray	www.wago.com/216-262
	Item no.: 216-301 Ferrule; Sleeve for 0.25 mm ² / AWG 24; insulated; electro-tin plated; yellow	www.wago.com/216-301
	Item no.: 216-321 Ferrule; Sleeve for 0.25 mm ² / AWG 24; insulated; electro-tin plated; yellow	www.wago.com/216-321
	Item no.: 216-322 Ferrule; Sleeve for 0.34 mm ² / 22 AWG; insulated; electro-tin plated; light turquoise	www.wago.com/216-322

Subject to changes. Please also observe the further product documentation!



	Item no.: 216-302 Ferrule; Sleeve for 0.34 mm ² / 22 AWG; insulated; electro-tin plated; light turquoise	www.wago.com/216-302
Insulation stop		
Insulation stop		
	Item no.: 734-671 Insulation stop; 0.08 - 0.2 mm ² "s" (0.14 mm ² "f-st"); 8 pieces/strip; light gray	www.wago.com/734-671
Tool		
Operating tool		
	Item no.: 210-250 Operating tool; for MCS MINI and MIDI with CAGE CLAMP® connection; red	www.wago.com/210-250
	Item no.: 210-251 Operating tool; for MCS MICRO and MINI with CAGE CLAMP® connection; yellow	www.wago.com/210-251
	Item no.: 210-647 Operating tool; Blade: 2.5 x 0.4 mm; with a partially insulated shaft; multicoloured	www.wago.com/210-647
	Item no.: 210-719 Operating tool; Blade: 2.5 x 0.4 mm; with a partially insulated shaft	www.wago.com/210-719
	Item no.: 734-230 Operating tool; made of insulating material; 1-way; white	www.wago.com/734-230
	Item no.: 734-190 Combination operating tool; natural	www.wago.com/734-190
	Item no.: 734-191 Operating tool; made of insulating material; 1-way; loose; black	www.wago.com/734-191
	Item no.: 734-231 Operating tool; black	www.wago.com/734-231
Strain relief		
Strain relief housing		
	Item no.: 734-610 Strain relief housing; for female and male connectors; 2 parts; Pin spacing 3.5 mm; 10-pole; light gray	www.wago.com/734-610
Strain relief plate		
	Item no.: 734-129 Strain relief plate; for female and male connectors; 25 mm wide; 1 part; Pin spacing 3.5 mm; light gray	www.wago.com/734-129

Subject to changes. Please also observe the further product documentation!



Marking accessories

Marking strip

	Item no.: 210-332/350-202 Marking strips; as a DIN A4 sheet; MARKED; 1-16 (240x); Height of marker strip: 3 mm; Strip length 182 mm; Horizontal marking; Self-adhesive; white	www.wago.com/210-332/350-202
	Item no.: 210-332/350-206 Marking strips; as a DIN A4 sheet; MARKED; 33-48 (240x); Height of marker strip: 3 mm; Strip length 182 mm; Horizontal marking; Self-adhesive; white	www.wago.com/210-332/350-206
	Item no.: 210-332/350-204 Marking strips; as a DIN A4 sheet; MARKED; 17-32 (240x); Height of marker strip: 3 mm; Strip length 182 mm; Horizontal marking; Self-adhesive; white	www.wago.com/210-332/350-204

Mounting

Mounting accessories

	Item no.: 209-137 Mounting adapter; can be used as end stop; 6.5 mm wide; gray	www.wago.com/209-137
--	--	--

Downloads

Documentation

Additional Information

Technical Section	2019 Apr 3	pdf	Download
Technical explanations		2.1 MB	

CAD/CAE-Data

CAE data

ZUKEN Portal 734-110/008-000	URL	Download
------------------------------	-----	----------

CAD data

2D/3D Models 734-110/008-000	URL	Download
------------------------------	-----	----------

Asset Administration Shell

Asset Administration Shell 734-110/008-000	URL	Download
--	-----	----------

Environmental Product Compliance

Compliance Search

Subject to changes. Please also observe the further product documentation!

Environmental Product Compliance 734-110/008-000

1-conductor female connector; CAGE CLAMP®; 1.5 mm²; Pin spacing 3.5 mm; 10-pole; 100% protected against mismatching; Snap-in mounting feet; 1,50 mm²; light gray

Installation Notes

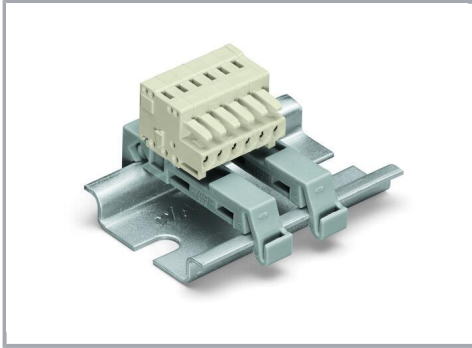

Using two DIN-35 rail mounting adapters (209-137) for 3 or more poles; distance between two mounting adapters: maximum 7 poles

Conductor termination

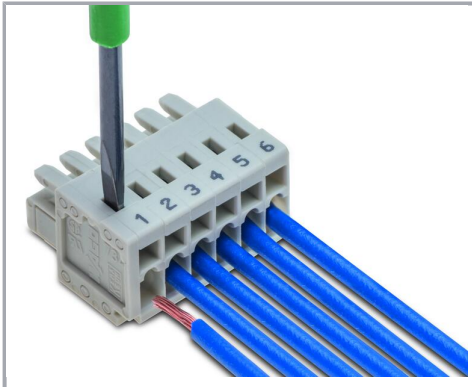

Inserting a conductor via (2.5 x 0.4) mm screwdriver – CAGE CLAMP® actuation perpendicular to conductor entry.

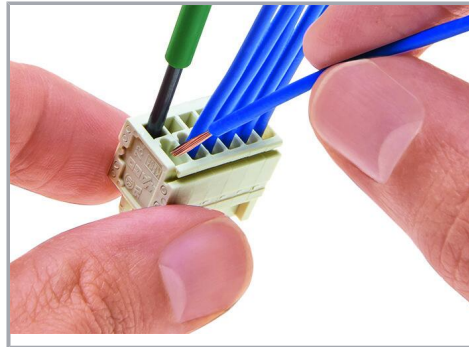

Inserting a conductor via (2.5 x 0.4) mm screwdriver – CAGE CLAMP® actuation parallel to conductor entry.

Subject to changes. Please also observe the further product documentation!

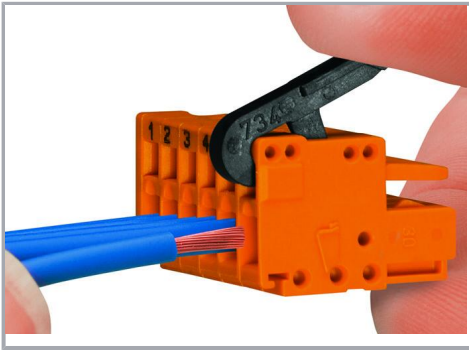

Inserting a conductor into CAGE CLAMP® unit via operating tool (734-191).

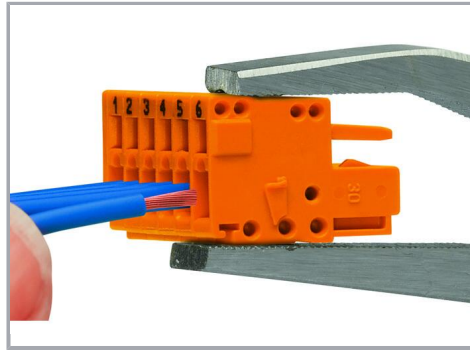

Inserting a conductor into CAGE CLAMP® unit via operating tool (210-251 or 210-250).

Coding

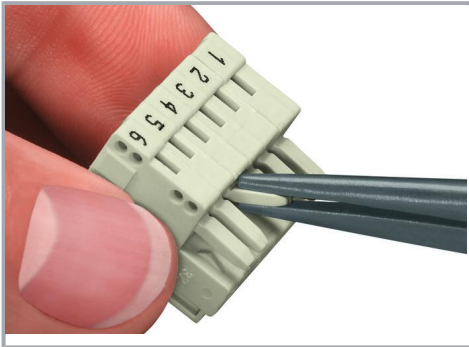

Coding a female connector – removing coding finger(s).

Testing

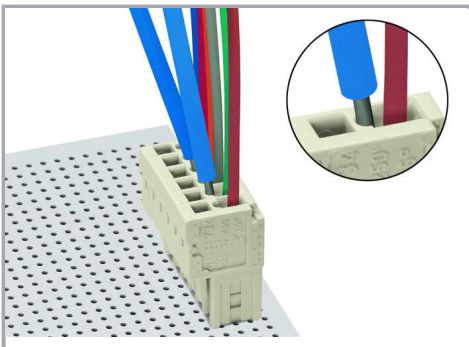

Testing via 1 mm Ø test pin (735-500) – CAGE CLAMP® connection – touch contact.

Marking

Subject to changes. Please also observe the further product documentation!

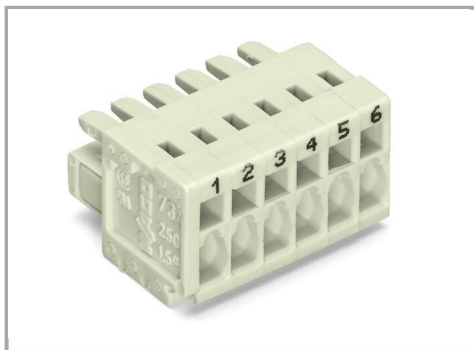

Labeling via direct marking or self-adhesive strips.

Installation

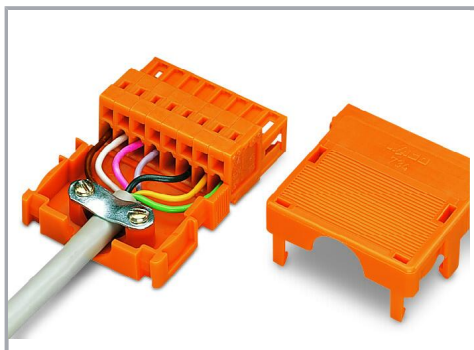

Strain relief housing for 734 Series Male and Female Connectors with CAGE CLAMP® connection

Product family

MCS MINI

[Show all products from the family](#)

Subject to changes. Please also observe the further product documentation!