

Data sheet | Item number: 769-110/000-006

1-conductor female connector; CAGE CLAMP®; 4 mm²; Pin spacing 5 mm;
10-pole; coding finger; 4,00 mm²; blue

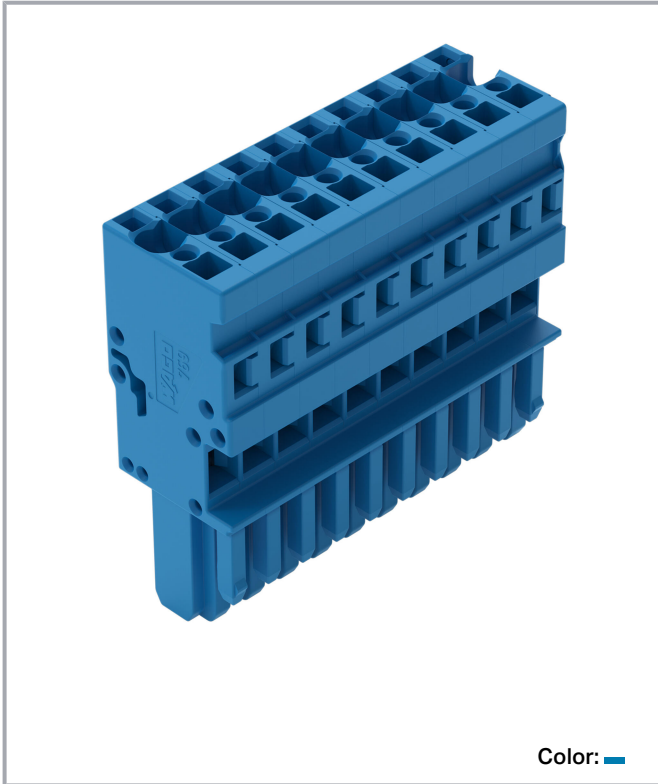

www.wago.com/769-110/000-006



Color: 

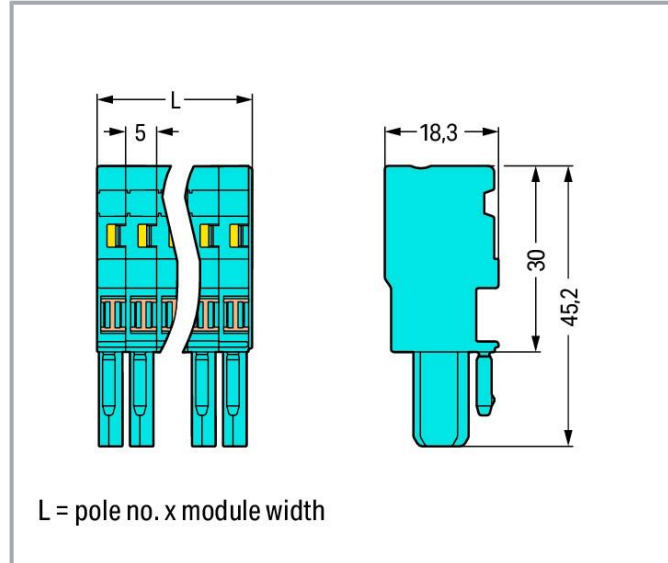

$L = \text{pole no.} \times \text{module width}$

Data

Notes

Safety information

According to EN 61984, pluggable connectors without current interrupting capacity must not be mated or unmated when live or under load.

Electrical data

Ratings per IEC/EN

Ratings per	IEC/EN 61984
Nominal voltage (III/3)	500 V
Rated impulse voltage (III/3)	6 kV
Rated current	32 A

Subject to changes. Please also observe the further product documentation!

WAGO GmbH & Co. KG
Hansastr. 27
32423 Minden
Phone: +49571 887-0 | Fax: +49571 887-169
Email: info.de@wago.com | Web: www.wago.com

Do you have any questions about our products?
We are always happy to take your call at +49 (571) 887-44222.



Legend (ratings)

(III / 3) $\hat{=}$ Overvoltage category III / Pollution degree 3

Connection data

Connection points	10
Total number of potentials	10

Connection 1

Connection technology	CAGE CLAMP®
Actuation type	Operating tool
Connectable conductor materials	Copper
Nominal cross-section	4 mm ² / 12 AWG
Solid conductor	0.08 ... 4 mm ² / 28 ... 12 AWG
Fine-stranded conductor	0.08 ... 4 mm ² / 28 ... 12 AWG
Strip length	8 ... 9 mm / 0.31 ... 0.35 inches
Pole number	10
Wiring direction	Front-entry wiring

Physical data

Width	50 mm / 1.969 inches
Height	45.2 mm / 1.78 inches
Depth	18.3 mm / 0.72 inches
Module width	5 mm / 0.197 inches

Mechanical Data

Variable coding	Yes
Direct ground contact to DIN-rail/drilled hole/housing	No
Marking level	Side marking
Anti-rotation protection	Yes

Plug-in connection

Contact type (pluggable connector)	Female connector/socket
Connector (connection type)	for conductor
Mismating protection	No
Plugging without loss of pin spacing	Yes

Subject to changes. Please also observe the further product documentation!



Material data

Note (material data)

Information on material specifications can be found here

Color	blue
Material group	I
Insulation material	Polyamide (PA66)
Flammability class per UL94	V0
Fire load	0.675 MJ
Halogen-free	Yes
Weight	32.7 g

Environmental requirements

Processing temperature	-35 ... +85 °C
Continuous operating temperature	-60 ... +105 °C

Commercial data

eCl@ss 10.0	27-14-11-06
eCl@ss 9.0	27-14-11-06
ETIM 8.0	EC001284
ETIM 7.0	EC001284
ECCN	NO DATA
PU (SPU)	25 pcs
Packaging type	box
Country of origin	DE
GTIN	4045454579869
Customs tariff number	85366990990

Environmental Product Compliance

RoHS Compliance Status	Compliant, No Exemption
------------------------	-------------------------

Approvals / Certificates

General approvals

Logo	Approval	Additional Approval Text	Certificate name
	CCA	EN 61984	2190419.02

Subject to changes. Please also observe the further product documentation!

WAGO GmbH & Co. KG
 Hansastr. 27
 32423 Minden
 Phone: +49571 887-0 | Fax: +49571 887-169
 Email: info.de@wago.com | Web: www.wago.com

Do you have any questions about our products?
 We are always happy to take your call at +49 (571) 887-44222.



DEKRA Certification B.V.



	CCA DEKRA Certification B.V.	EN 60947	NTR NL-7626
	CCA DEKRA Certification B.V.	IEC 61984	NL-47799/A1
	CSA CSA Group	C22.2	1101144
	KEMA/KEUR DEKRA Certification B.V.	EN 60947	2190419.01
	UL Underwriters Laboratories Inc.	UL 1977	E 45171
	UR Underwriters Laboratories Inc.	UL 1059	E45172

Declarations of conformity and manufacturer's declarations

Logo	Approval	Additional Approval Text	Certificate name
	EU-Declaration of Conformity WAGO GmbH & Co. KG	-	-
	UK-Declaration of Conformity WAGO GmbH & Co. KG	-	-

Optional accessories

Cover

Subject to changes. Please also observe the further product documentation!

WAGO GmbH & Co. KG
 Hansastr. 27
 32423 Minden
 Phone: +49571 887-0 | Fax: +49571 887-169
 Email: info.de@wago.com | Web: www.wago.com

Do you have any questions about our products?
 We are always happy to take your call at +49 (571) 887-44222.



Item no.: 769-436
Jumper cover; for 1-conductor female plugs; for 5 poles; gray

www.wago.com/769-436

Protective warning marker

Cover



Item no.: 280-415
Protective warning marker; for 5 terminal blocks; with high-voltage symbol, black; yellow

www.wago.com/280-415

Jumpers

Jumper



Item no.: 769-402
Jumper; insulated; gray

www.wago.com/769-402

Tool

Operating tool



Item no.: 210-490
Operating tool

www.wago.com/210-490



Item no.: 769-434
Operating tool; made of insulating material; 1-way; loose; white

www.wago.com/769-434

Marking accessories

Marking strip



Item no.: 210-831
Marking strips; on reel; 2.3 mm wide; plain; Self-adhesive; white

www.wago.com/210-831



Item no.: 210-834
Marking strips; on reel; 5 mm wide; plain; Self-adhesive; white

www.wago.com/210-834



Item no.: 210-832
Marking strips; on reel; 3 mm wide; plain; Self-adhesive; white

www.wago.com/210-832

Label



Item no.: 210-805
Labels; for Smart Printer; permanent adhesive; 6 x 15 mm; white

www.wago.com/210-805



Item no.: 210-805/000-002
Labels; for Smart Printer; permanent adhesive; 6 x 15 mm; yellow

www.wago.com/210-805/000-002

Marker



Item no.: 2009-145
Mini-WSB Inline; for Smart Printer; 1700 pieces on roll; stretchable 5 - 5.2 mm; plain; snap-on type; white

www.wago.com/2009-145



Item no.: 248-501
Mini-WSB marking card; as card; not stretchable; plain; snap-on type; white

www.wago.com/248-501

Subject to changes. Please also observe the further product documentation!

Strain relief

Strain relief



Item no.: 769-1610

Strain relief housing; for female and male connectors; 2 parts; Pin spacing 5 mm; 10-pole; gray

www.wago.com/769-1610



Item no.: 769-414

Strain relief plate; for female and male connectors; 1 part; Pin spacing 5 mm; 10- to 15-pole; gray

www.wago.com/769-414

Testing and measuring

Testing accessories



Item no.: 210-136

Test plug; 2 mm Ø; with 500 mm cable; red

www.wago.com/210-136

Locking levers

Locking system



Item no.: 769-430

Locking lever; for female connectors; 1 part; Pin spacing 5 mm; 2-pole; gray

www.wago.com/769-430



Item no.: 769-431

Locking lever; for female connectors; 1 part; Pin spacing 5 mm; 2-pole; orange

www.wago.com/769-431

Insulation stop

Insulation stop



Item no.: 769-470

Insulation stop; 0.08 - 0.2 mm² "s" (0.14 mm² "f-st"); 5 pieces/strip; white

www.wago.com/769-470



Item no.: 769-471

Insulation stop; 0.25 - 0.5 mm²; 5 pieces/strip; light gray

www.wago.com/769-471



Item no.: 769-472

Insulation stop; 0.75 - 1 mm²; 5 pieces/strip; dark gray

www.wago.com/769-472

Ferrule

Ferrule

I

Item no.: 216-101

Ferrule; Sleeve for 0.5 mm² / AWG 22; uninsulated; electro-tin plated; silver-colored

www.wago.com/216-101

I

Item no.: 216-104

Ferrule; Sleeve for 1.5 mm² / AWG 16; uninsulated; electro-tin plated; silver-colored

www.wago.com/216-104

I

Item no.: 216-102

Ferrule; Sleeve for 0.75 mm² / AWG 20; uninsulated; electro-tin plated; silver-colored

www.wago.com/216-102

I

Subject to changes. Please also observe the further product documentation!

WAGO GmbH & Co. KG

Hansastr. 27

32423 Minden









Phone: +49571 887-0 | Fax: +49571 887-169

Email: info.de@wago.com | Web: www.wago.com

Do you have any questions about our products?

We are always happy to take your call at +49 (571) 887-44222.



	Item no.: 216-103 Ferrule; Sleeve for 1 mm ² / AWG 18; uninsulated; electro-tin plated	www.wago.com/216-103
	Item no.: 216-203 Ferrule; Sleeve for 1 mm ² / AWG 18; insulated; electro-tin plated; red	www.wago.com/216-203
	Item no.: 216-206 Ferrule; Sleeve for 2.5 mm ² / AWG 14; insulated; electro-tin plated; blue	www.wago.com/216-206
	Item no.: 216-202 Ferrule; Sleeve for 0.75 mm ² / 18 AWG; insulated; electro-tin plated; gray	www.wago.com/216-202
	Item no.: 216-204 Ferrule; Sleeve for 1.5 mm ² / AWG 16; insulated; electro-tin plated; black	www.wago.com/216-204
	Item no.: 216-201 Ferrule; Sleeve for 0.5 mm ² / 20 AWG; insulated; electro-tin plated; white	www.wago.com/216-201
	Item no.: 216-301 Ferrule; Sleeve for 0.25 mm ² / AWG 24; insulated; electro-tin plated; yellow	www.wago.com/216-301
	Item no.: 216-302 Ferrule; Sleeve for 0.34 mm ² / 22 AWG; insulated; electro-tin plated; light turquoise	www.wago.com/216-302

Downloads

Documentation

Bid Text

769-110/000-006 X81 - Datei	2019 Feb 19	xml 3.3 kB	Download
769-110/000-006 doc - Datei	2017 Oct 4	doc 25.6 kB	Download

Additional Information

		pdf 2.3 MB	Download
--	--	---------------	----------

CAD/CAE-Data

CAD data

2D/3D Models 769-110/000-006		URL	Download
------------------------------	--	-----	----------

CAE data

EPLAN Data Portal 769-110/000-006		URL	Download
-----------------------------------	--	-----	----------

Subject to changes. Please also observe the further product documentation!

WAGO GmbH & Co. KG
Hansastr. 27
32423 Minden
Phone: +49571 887-0 | Fax: +49571 887-169
Email: info.de@wago.com | Web: www.wago.com

Do you have any questions about our products?
We are always happy to take your call at +49 (571) 887-44222.

WSCAD Universe 769-110/000-006	URL	Download
ZUKEN Portal 769-110/000-006	URL	Download
EPLAN Data Portal 769-110/000-006	URL	Download
WSCAD Universe 769-110/000-006	URL	Download
Asset Administration Shell		
Asset Administration Shell 769-110/000-006	URL	Download

Environmental Product Compliance

Compliance Search

Environmental Product Compliance 769-110/000-006	URL	Download
1-conductor female connector; CAGE CLAMP®; 4 mm ² ; Pin spacing 5 mm; 10-pole; coding finger; 4,00 mm ² ; blue		

Installation Notes

Conductor termination

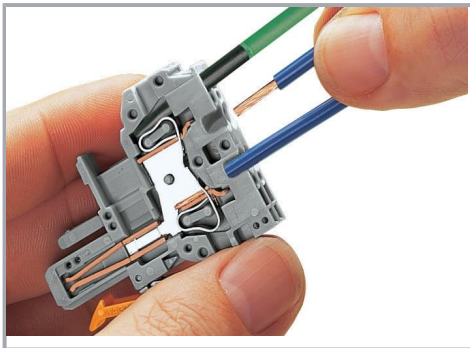

CAGE CLAMP® connection

Female plug: Inserting/removing a conductor via operating tool.

Operation 90° to conductor is also possible.

With ferruled conductors, it is necessary to use a terminal block one size smaller than the conductor's nominal cross-section.

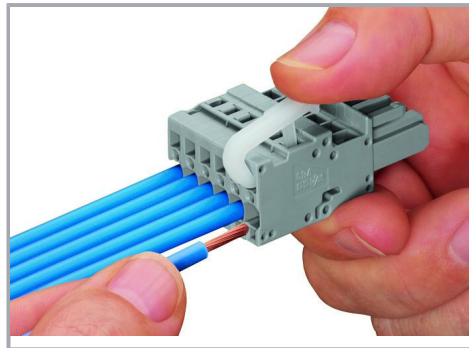

Operating lever

Inserting a conductor – side-entry wiring (example shows a female plug).

Subject to changes. Please also observe the further product documentation!

WAGO GmbH & Co. KG

Hansastr. 27

32423 Minden

Phone: +49571 887-0 | Fax: +49571 887-169

Email: info.de@wago.com | Web: www.wago.com

Do you have any questions about our products?

We are always happy to take your call at +49 (571) 887-44222.

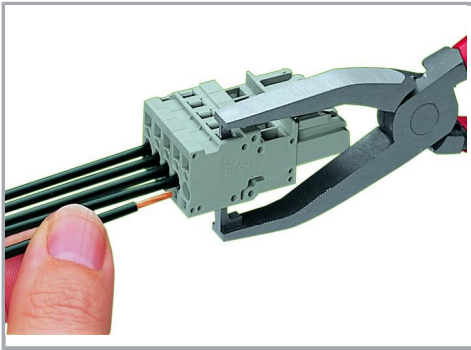

Operating tool

Inserting a conductor – side-entry wiring
(example shows a female plug).

With ferruled conductors, it is necessary to
use a terminal block one size smaller than the
conductor's nominal cross-section.

Commoning

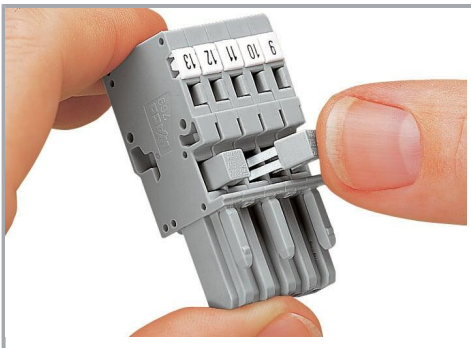

Commoning 1-conductor female plugs via
miniature adjacent jumpers.

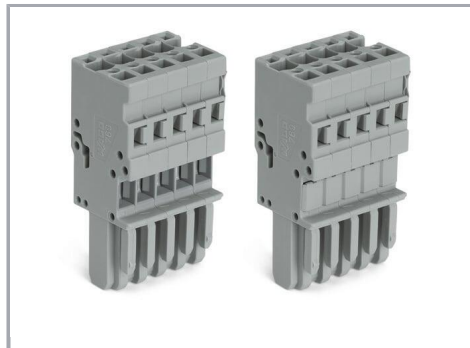

Jumper cover for 1-conductor female plugs

Coding

Subject to changes. Please also observe the further product documentation!



Coding a female plug by removing coding finger(s) via cutting tool. Do not remove the first and last coding fingers or use an additional locking lever.

Locking system

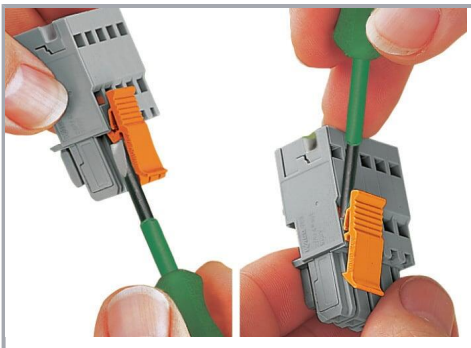

Locking/releasing a lever.

Strain relief

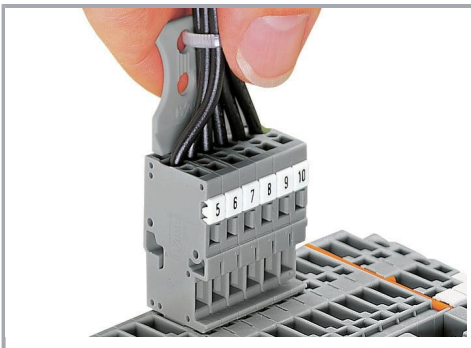

Removing a female plug via conductor bundle provided with strain relief plate.

Marking

Subject to changes. Please also observe the further product documentation!

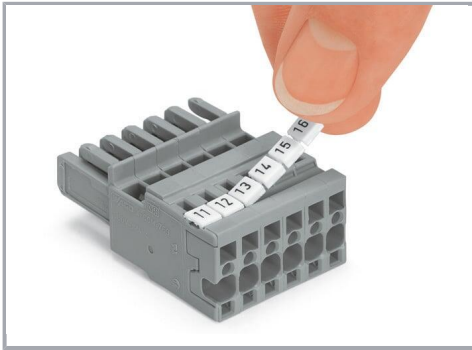

Labeling a female plug with CAGE CLAMP® connection via Mini-WSB Quick Markers.

Product family

X-COM

[Show all products from the family](#)

Subject to changes. Please also observe the further product documentation!