

MC 1,5/ 6-G-3,5 - PCB header



1844252

<https://www.phoenixcontact.com/us/products/1844252>

Please be informed that the data shown in this PDF document is generated from our online catalog. Please find the complete data in the user documentation. Our general terms of use for downloads are valid.



PCB headers, nominal cross section: 1.5 mm², color: green, nominal current: 8 A, rated voltage (III/2): 160 V, contact surface: Tin, contact connection type: Pin, number of potentials: 6, number of rows: 1, number of positions: 6, number of connections: 6, product range: MC 1,5/...-G, pitch: 3.5 mm, mounting: Wave soldering, pin layout: Linear pinning, solder pin [P]: 3.4 mm, number of solder pins per potential: 1, plug-in system: COMBICON MC 1,5, Pin connector pattern alignment: Standard, locking: without, mounting: without, type of packaging: packed in cardboard

Your advantages

- Well-known mounting principle allows worldwide use
- Maximum flexibility when it comes to device design – one header for connectors with different connection technologies

Commercial data

| | |
|--------------------------------------|---------------------|
| Item number | 1844252 |
| Packing unit | 100 pc |
| Minimum order quantity | 100 pc |
| Sales key | AA02 |
| Product key | AABSAA |
| Catalog page | Page 224 (C-1-2013) |
| GTIN | 4017918113292 |
| Weight per piece (including packing) | 1.648 g |
| Weight per piece (excluding packing) | 1.5 g |
| Customs tariff number | 85366930 |
| Country of origin | DE |

MC 1,5/ 6-G-3,5 - PCB header



1844252

<https://www.phoenixcontact.com/us/products/1844252>

Technical data

Product properties

| | |
|---------------------------|-----------------------|
| Type | Standard |
| Product line | COMBICON Connectors S |
| Product type | PCB headers |
| Product family | MC 1,5/...-G |
| Number of positions | 6 |
| Pitch | 3.5 mm |
| Number of connections | 6 |
| Number of rows | 1 |
| Mounting flange | without |
| Number of potentials | 6 |
| Pin layout | Linear pinning |
| Solder pins per potential | 1 |

Electrical properties

| | |
|-----------------------------|----------------|
| Nominal current I_N | 8 A |
| Nominal voltage U_N | 160 V |
| Degree of pollution | 3 |
| Contact resistance | 1.3 m Ω |
| Rated voltage (III/3) | 160 V |
| Rated surge voltage (III/3) | 2.5 kV |
| Rated voltage (III/2) | 160 V |
| Rated surge voltage (III/2) | 2.5 kV |
| Rated voltage (II/2) | 250 V |
| Rated surge voltage (II/2) | 2.5 kV |

Mounting

| | |
|---------------|----------------|
| Mounting type | Wave soldering |
| Pin layout | Linear pinning |

Material specifications

Material data - contact

| | |
|---------------------------------------------|----------------------------------------------------------------------------------|
| Note | WEEE/RoHS-compliant, free of whiskers according to IEC 60068-2-82/JEDEC JESD 201 |
| Contact material | Cu alloy |
| Surface characteristics | Tin-plated |
| Metal surface contact area (top layer) | Tin (3 - 5 μm Sn) |
| Metal surface contact area (middle layer) | Nickel (1.3 - 3 μm Ni) |
| Metal surface soldering area (top layer) | Tin (3 - 5 μm Sn) |
| Metal surface soldering area (middle layer) | Nickel (1.3 - 3 μm Ni) |

Material data - housing

MC 1,5/ 6-G-3,5 - PCB header

1844252

<https://www.phoenixcontact.com/us/products/1844252>

| | |
|----------------------------------------|--------------|
| Color (Housing) | green (6021) |
| Insulating material | PBT |
| Insulating material group | IIIa |
| CTI according to IEC 60112 | 225 |
| Flammability rating according to UL 94 | V0 |

Dimensions

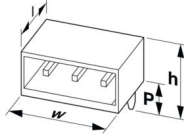
| | |
|-----------------------|------------------------------------------------------------------------------------|
| Dimensional drawing |  |
| Pitch | 3.5 mm |
| Width [w] | 22.4 mm |
| Height [h] | 10.65 mm |
| Length [l] | 9.2 mm |
| Installed height | 7.25 mm |
| Solder pin length [P] | 3.4 mm |
| Pin dimensions | 0.8 x 0.8 mm |

PCB design

| | |
|---------------|--------|
| Hole diameter | 1.2 mm |
|---------------|--------|

Mechanical tests

Visual inspection

| | |
|---------------|-----------------------|
| Specification | IEC 60512-1-1:2002-02 |
| Result | Test passed |

Dimension check

| | |
|---------------|-----------------------|
| Specification | IEC 60512-1-2:2002-02 |
| Result | Test passed |

Resistance of inscriptions

| | |
|---------------|------------------------|
| Specification | IEC 60068-2-70:1995-12 |
| Result | Test passed |

Polarization and coding

| | |
|---------------|------------------------|
| Specification | IEC 60512-13-5:2006-02 |
| Result | Test passed |

Contact holder in insert

| | |
|------------------------------------------------|------------------------|
| Specification | IEC 60512-15-1:2008-05 |
| Contact holder in insert Requirements >20 N | Test passed |

Insertion and withdrawal forces

MC 1,5/ 6-G-3,5 - PCB header



1844252

<https://www.phoenixcontact.com/us/products/1844252>

| | |
|-------------------------------------|-------------|
| Result | Test passed |
| No. of cycles | 25 |
| Insertion strength per pos. approx. | 6 N |
| Withdraw strength per pos. approx. | 4 N |

Electrical tests

Thermal test | Test group C

| | |
|----------------------------|-----------------------|
| Specification | IEC 60512-5-1:2002-02 |
| Tested number of positions | 20 |

Insulation resistance

| | |
|----------------------------------------------|-----------------------|
| Specification | IEC 60512-3-1:2002-02 |
| Insulation resistance, neighboring positions | > 5 MΩ |

Air clearances and creepage distances |

| | |
|--------------------------------------------------------|---------------------|
| Specification | IEC 60664-1:2007-04 |
| Insulating material group | IIIa |
| Comparative tracking index (IEC 60112) | CTI 225 |
| Rated insulation voltage (III/3) | 160 V |
| Rated surge voltage (III/3) | 2.5 kV |
| minimum clearance value - non-homogenous field (III/3) | 1.5 mm |
| minimum creepage distance (III/3) | 2.5 mm |
| Rated insulation voltage (III/2) | 160 V |
| Rated surge voltage (III/2) | 2.5 kV |
| minimum clearance value - non-homogenous field (III/2) | 1.5 mm |
| minimum creepage distance (III/2) | 1.6 mm |
| Rated insulation voltage (II/2) | 250 V |
| Rated surge voltage (II/2) | 2.5 kV |
| minimum clearance value - non-homogenous field (II/2) | 1.5 mm |
| minimum creepage distance (II/2) | 2.5 mm |

Environmental and real-life conditions

Vibration test

| | |
|------------------------|-----------------------------|
| Specification | IEC 60068-2-6:2007-12 |
| Frequency | 10 - 150 - 10 Hz |
| Sweep speed | 1 octave/min |
| Amplitude | 0.35 mm (10 Hz ... 60.1 Hz) |
| Sweep speed | 5g (60.1 Hz ... 150 Hz) |
| Test duration per axis | 2.5 h |

Durability test

| | |
|----------------------------------------|-----------------------|
| Specification | IEC 60512-9-1:2010-03 |
| Impulse withstand voltage at sea level | 2.95 kV |
| Contact resistance R ₁ | 1.3 mΩ |

MC 1,5/ 6-G-3,5 - PCB header



1844252

<https://www.phoenixcontact.com/us/products/1844252>

| | |
|----------------------------------------------|----------------|
| Contact resistance R_2 | 1.4 m Ω |
| Insertion/withdrawal cycles | 25 |
| Insulation resistance, neighboring positions | > 5 M Ω |

Climatic test

| | |
|-----------------------------------|---------------------------------------------------------------------------|
| Specification | ISO 6988:1985-02 |
| Corrosive stress | 0.2 dm ³ SO ₂ on 300 dm ³ /40 °C/1 cycle |
| Thermal stress | 100 °C/168 h |
| Power-frequency withstand voltage | 1.39 kV |

Ambient conditions

| | |
|-----------------------------------------|-----------------------------------------------------|
| Ambient temperature (operation) | -40 °C ... 100 °C (dependent on the derating curve) |
| Ambient temperature (storage/transport) | -40 °C ... 70 °C |
| Relative humidity (storage/transport) | 30 % ... 70 % |
| Ambient temperature (assembly) | -5 °C ... 100 °C |

Packaging specifications

| | |
|-------------------|---------------------|
| Type of packaging | packed in cardboard |
|-------------------|---------------------|

MC 1,5/ 6-G-3,5 - PCB header

1844252

<https://www.phoenixcontact.com/us/products/1844252>

Drawings

Dimensional drawing

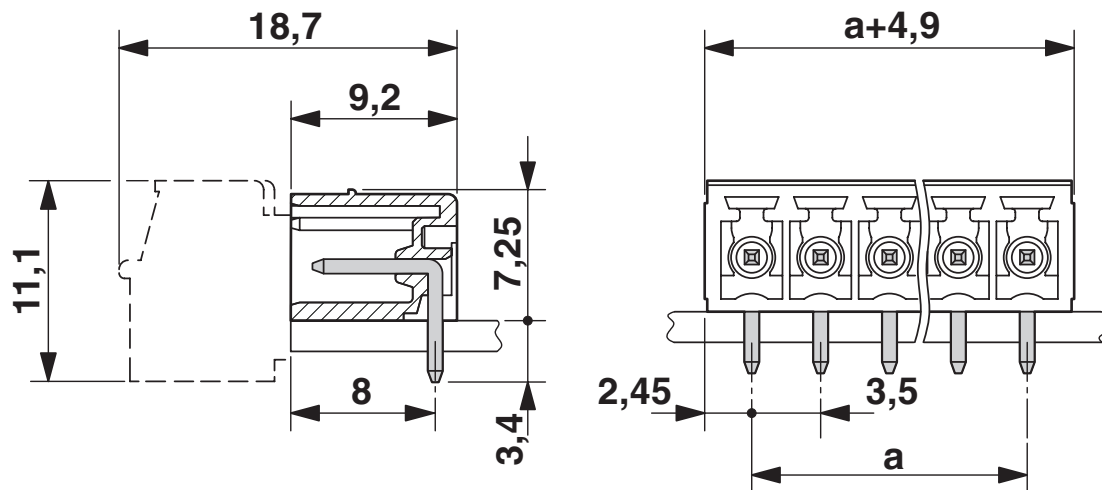

Drilling plan/solder pad geometry

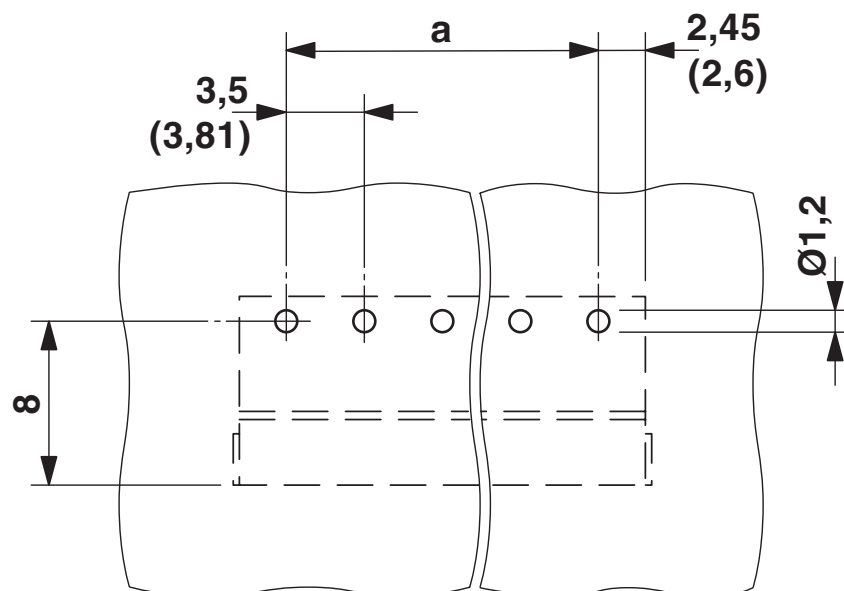

MC 1,5/ 6-G-3,5 - PCB header

1844252

<https://www.phoenixcontact.com/us/products/1844252>

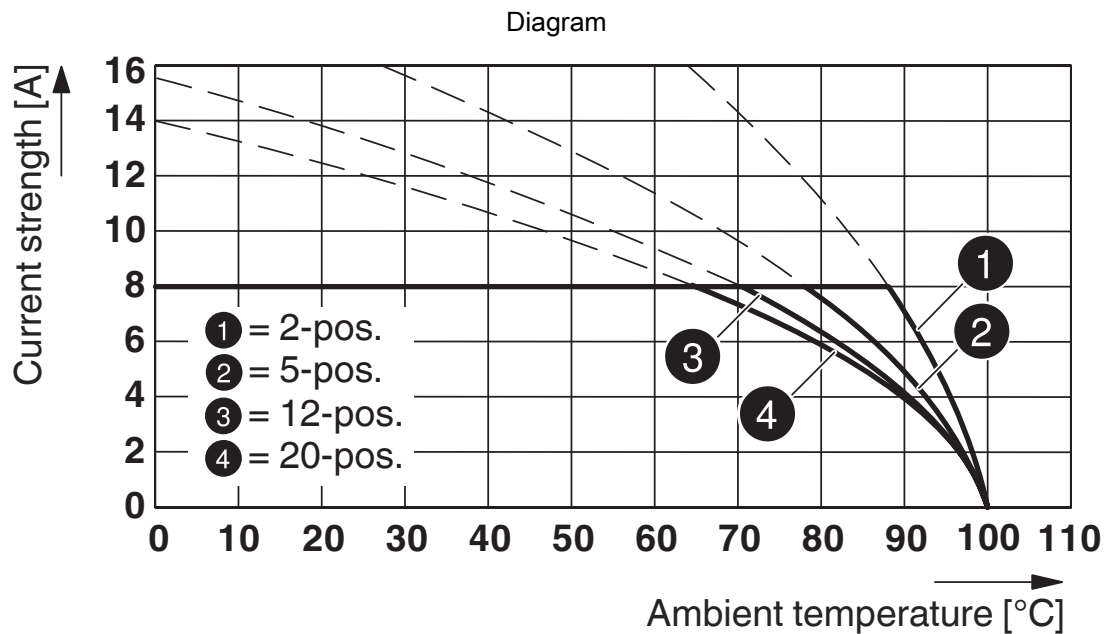

Type: FK-MCP 1,5/...-ST-3,5 with MC 1,5/...-G-3,5

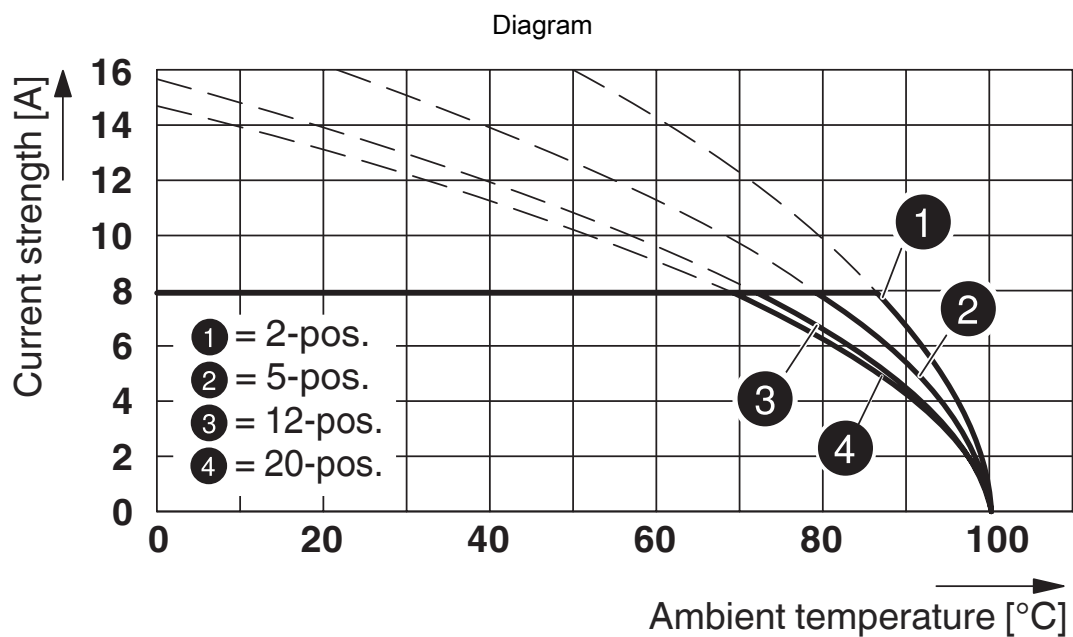

Type: MC 1,5/...-ST-3,5 with MC 1,5/...-G-3,5

MC 1,5/ 6-G-3,5 - PCB header

1844252

<https://www.phoenixcontact.com/us/products/1844252>

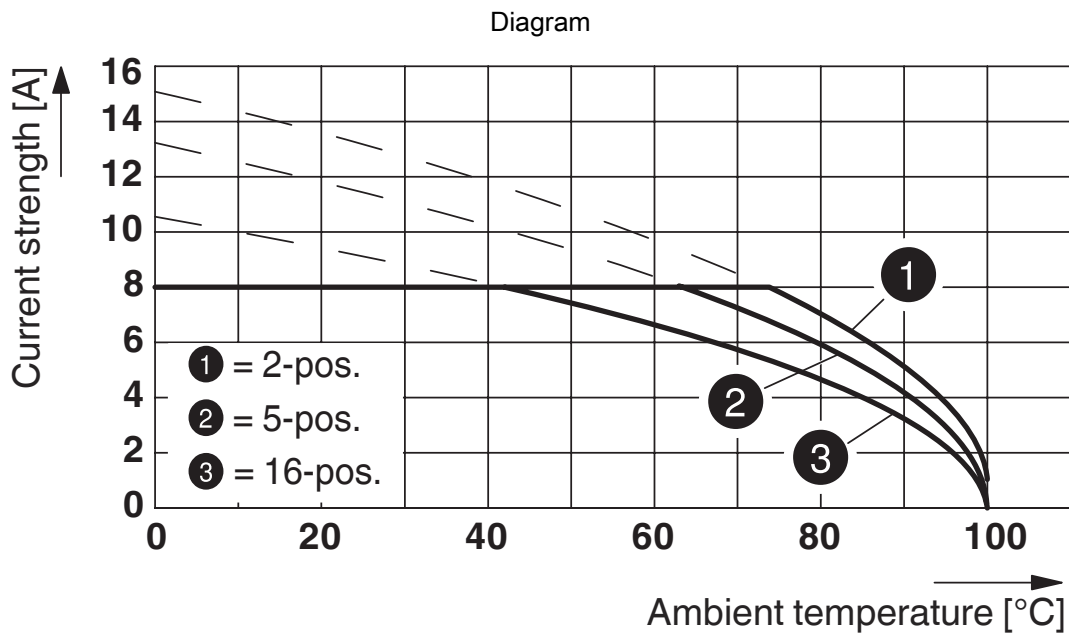

Type: MCVW 1,5/...-ST-3,5 with MC 1,5/...-G-3,5

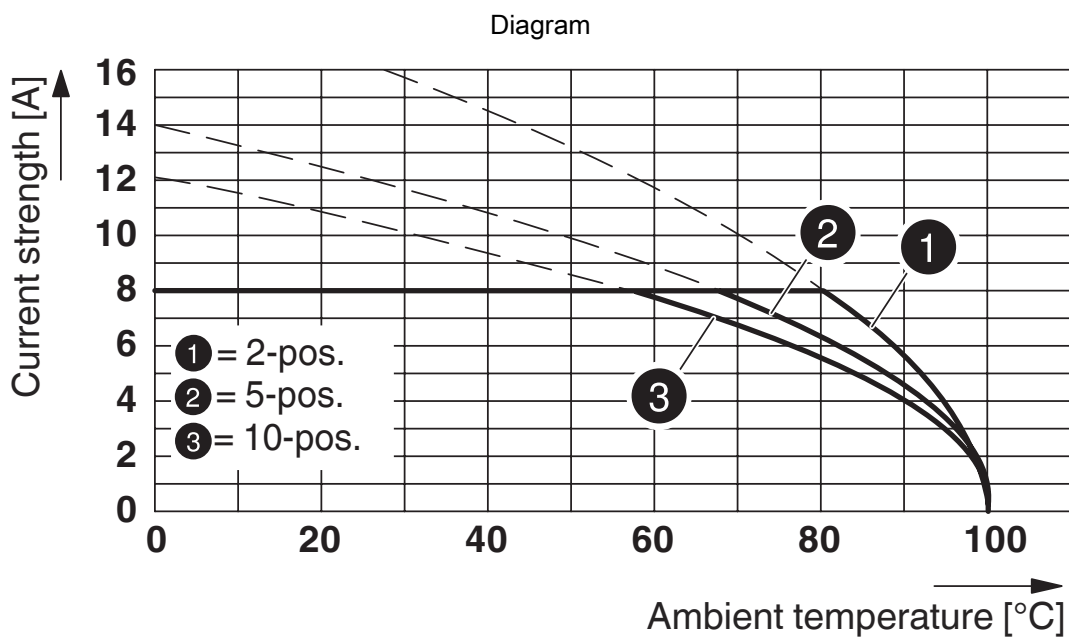

Type: TFMC 1,5/...-ST-3,5 with MC 1,5/...-G-3,5

MC 1,5/ 6-G-3,5 - PCB header





1844252

<https://www.phoenixcontact.com/us/products/1844252>

Approvals

To download certificates, visit the product detail page: <https://www.phoenixcontact.com/us/products/1844252>

|  VDE Zeichengenehmigung Approval ID: 40057836 | | | | |
|------------------------------------------------------------------------------------------------------------------------------------------|-----------------------|-----------------------|-------------------|-----------------------------|
| | Nominal voltage U_N | Nominal current I_N | Cross section AWG | Cross section mm^2 |
| | 160 V | 8 A | - | - |

|  CSA Approval ID: 13631 | | | | |
|--------------------------------------------------------------------------------------------------------------------|-----------------------|-----------------------|-------------------|-----------------------------|
| | Nominal voltage U_N | Nominal current I_N | Cross section AWG | Cross section mm^2 |
| Use group B | 300 V | 8 A | - | - |
| Use group D | 300 V | 8 A | - | - |

|  cULus Recognized Approval ID: E60425-20110128 | | | | |
|---------------------------------------------------------------------------------------------------------------------------------------------|-----------------------|-----------------------|-------------------|-----------------------------|
| | Nominal voltage U_N | Nominal current I_N | Cross section AWG | Cross section mm^2 |
| Use group B | 300 V | 8 A | - | - |
| Use group D | 300 V | 8 A | - | - |

|  VDE Zeichengenehmigung Approval ID: 40011723 | | | | |
|--------------------------------------------------------------------------------------------------------------------------------------------|-----------------------|-----------------------|-------------------|-----------------------------|
| | Nominal voltage U_N | Nominal current I_N | Cross section AWG | Cross section mm^2 |
| | 160 V | 8 A | - | - |

MC 1,5/ 6-G-3,5 - PCB header



1844252

<https://www.phoenixcontact.com/us/products/1844252>

Classifications

ECLASS

| | |
|-------------|----------|
| ECLASS-11.0 | 27460201 |
| ECLASS-12.0 | 27460201 |
| ECLASS-13.0 | 27460201 |

ETIM

| | |
|----------|----------|
| ETIM 9.0 | EC002637 |
|----------|----------|

UNSPSC

| | |
|-------------|----------|
| UNSPSC 21.0 | 39121400 |
|-------------|----------|

MC 1,5/ 6-G-3,5 - PCB header

1844252

<https://www.phoenixcontact.com/us/products/1844252>



Environmental product compliance

| | |
|------------|---------------------------------------------------------|
| China RoHS | Environmentally friendly use period: unlimited = EFUP-e |
| | No hazardous substances above threshold values |

MC 1,5/ 6-G-3,5 - PCB header

1844252

<https://www.phoenixcontact.com/us/products/1844252>



Accessories

CP-MSTB - Coding profile

1734634

<https://www.phoenixcontact.com/us/products/1734634>

Coding profile, is inserted into the slot on the plug or inverted header, red insulating material



MC 1,5/10-LWL 1,5-3,5 - Fiber optic

1841161

<https://www.phoenixcontact.com/us/products/1841161>

MINI COMBICON fiber optics, 3.5 mm pitch, 10-pos., separable for other numbers of positions (minimum: 2-pos.), inserts into the back of the MC header, color: transparent, dimension a: 1.5 mm



MC 1,5/ 6-G-3,5 - PCB header

1844252

<https://www.phoenixcontact.com/us/products/1844252>



MC 1,5/10-LWL 2,3-3,5 - Fiber optic

1841187

<https://www.phoenixcontact.com/us/products/1841187>

MINI COMBICON fiber optics, 3.5 mm pitch, 10-pos., separable for other numbers of positions (minimum: 2-pos.), inserts into the back of the MC header, color: transparent, dimension a: 2.3 mm



MC 1,5/10-LWL 4-3,5 - Fiber optic

1841200

<https://www.phoenixcontact.com/us/products/1841200>

MINI COMBICON fiber optics, 3.5 mm pitch, 10-pos., separable for other numbers of positions (minimum: 2-pos.), inserts into the back of the MC header, color: transparent, dimension a: 4 mm



MC 1,5/ 6-G-3,5 - PCB header

1844252

<https://www.phoenixcontact.com/us/products/1844252>



SK 3,5/2,8:FORTL.ZAHLEN - Marker card

0804073

<https://www.phoenixcontact.com/us/products/0804073>



Marker card, Sheet, white, labeled, horizontal: consecutive numbers 1 ... 10, 11 .. 20, etc. up to 91 ... 99, mounting type: adhesive, for terminal block width: 3.5 mm, lettering field size: 3.5 x 2.8 mm, Number of individual labels: 14

TFMC 1,5/ 6-ST-3,5 - Printed-circuit board connector

1772650

<https://www.phoenixcontact.com/us/products/1772650>

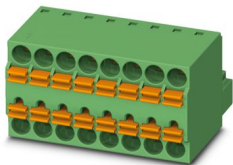

PCB connector, nominal cross section: 1.5 mm², color: green, nominal current: 8 A, rated voltage (III/2): 160 V, contact surface: Tin, contact connection type: Socket, number of potentials: 6, number of rows: 1, number of positions: 6, number of connections: 12, product range: TFMC 1,5/..-ST, pitch: 3.5 mm, connection method: Push-in spring connection, conductor/PCB connection direction: 0 °, plug-in system: COMBICON MC 1,5, locking: without, mounting: without, type of packaging: packed in cardboard

MC 1,5/ 6-G-3,5 - PCB header

1844252

<https://www.phoenixcontact.com/us/products/1844252>



MC 1,5/ 6-ST-3,5 - PCB connector

1840405

<https://www.phoenixcontact.com/us/products/1840405>

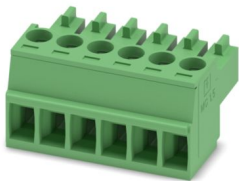

PCB connector, nominal cross section: 1.5 mm², color: green, nominal current: 8 A, rated voltage (III/2): 160 V, contact surface: Tin, contact connection type: Socket, number of potentials: 6, number of rows: 1, number of positions: 6, number of connections: 6, product range: MC 1,5/...-ST, pitch: 3.5 mm, connection method: Screw connection with tension sleeve, screw head form: L Slotted, conductor/PCB connection direction: 0 °, plug-in system: COMBICON MC 1,5, locking: without, mounting: without, type of packaging: packed in cardboard

MCVW 1,5/ 6-ST-3,5 - PCB connector

1862894

<https://www.phoenixcontact.com/us/products/1862894>

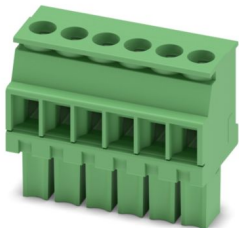

PCB connector, nominal cross section: 1.5 mm², color: green, nominal current: 8 A, rated voltage (III/2): 160 V, contact surface: Tin, contact connection type: Socket, number of potentials: 6, number of rows: 1, number of positions: 6, number of connections: 6, product range: MCVW 1,5/...-ST, pitch: 3.5 mm, connection method: Screw connection with tension sleeve, screw head form: L Slotted, conductor/PCB connection direction: -90 °, plug-in system: COMBICON MC 1,5, locking: without, mounting: without, type of packaging: packed in cardboard

MC 1,5/ 6-G-3,5 - PCB header

1844252

<https://www.phoenixcontact.com/us/products/1844252>



MCVR 1,5/ 6-ST-3,5 - PCB connector

1863194

<https://www.phoenixcontact.com/us/products/1863194>

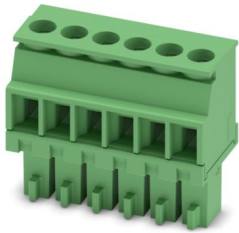

PCB connector, nominal cross section: 1.5 mm², color: green, nominal current: 8 A, rated voltage (III/2): 160 V, contact surface: Tin, contact connection type: Socket, number of potentials: 6, number of rows: 1, number of positions: 6, number of connections: 6, product range: MCVR 1,5/...-ST, pitch: 3.5 mm, connection method: Screw connection with tension sleeve, screw head form: L Slotted, conductor/PCB connection direction: 90 °, plug-in system: COMBICON MC 1,5, locking: without, mounting: without, type of packaging: packed in cardboard

FK-MCP 1,5/ 6-ST-3,5 - PCB connector

1939950

<https://www.phoenixcontact.com/us/products/1939950>

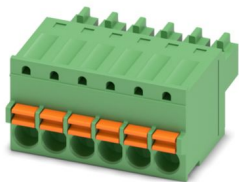

PCB connector, nominal cross section: 1.5 mm², color: green, nominal current: 8 A, rated voltage (III/2): 160 V, contact surface: Tin, contact connection type: Socket, number of potentials: 6, number of rows: 1, number of positions: 6, number of connections: 6, product range: FK-MCP 1,5/...-ST, pitch: 3.5 mm, connection method: Push-in spring connection, conductor/PCB connection direction: 0 °, plug-in system: COMBICON MC 1,5, locking: without, mounting: without, type of packaging: packed in cardboard

MC 1,5/ 6-G-3,5 - PCB header

1844252

<https://www.phoenixcontact.com/us/products/1844252>



FMC 1,5/ 6-ST-3,5 - Printed-circuit board connector

1952306

<https://www.phoenixcontact.com/us/products/1952306>

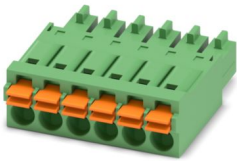

PCB connector, nominal cross section: 1.5 mm², color: green, nominal current: 8 A, rated voltage (III/2): 160 V, contact surface: Tin, contact connection type: Socket, number of potentials: 6, number of rows: 1, number of positions: 6, number of connections: 6, product range: FMC 1,5/..-ST, pitch: 3.5 mm, connection method: Push-in spring connection, conductor/PCB connection direction: 0 °, plug-in system: COMBICON MC 1,5, locking: without, mounting: without, type of packaging: packed in cardboard

XPC 1,5/ 6-ST-3,5 BK - PCB connector

1464109

<https://www.phoenixcontact.com/us/products/1464109>



PCB connector, nominal cross section: 1.5 mm², color: black, nominal current: 8 A, rated voltage (III/2): 160 V, contact surface: Tin, contact connection type: Socket, number of rows: 1, number of positions: 6, product range: XPC 1,5/..-ST, pitch: 3.5 mm, connection method: Push-X-connection, conductor/PCB connection direction: 0 °, locking clip: - without locking clip, plug-in system: COMBICON MC 1,5, locking: without, mounting: without, type of packaging: packed in cardboard

Phoenix Contact 2024 © - all rights reserved
<https://www.phoenixcontact.com>

Phoenix Contact USA
586 Fulling Mill Road
Middletown, PA 17057, United States
(+717) 944-1300
info@phoenixcon.com