

Item description

Male connector/plug *WINSTA*[®] MIDI with protection type IP20

The *WINSTA*[®] MIDI male connector/plug A coding is the pluggable solution for your use in control cabinets, for lighting connections or on PCBs. WAGO pluggable installation connectors can be used when criteria repeat or are planned on a defined pattern, for example for installing grid lighting or flush-mount lighting. For greater protection in electrical installations, the pluggable installation connector is equipped with mechanical protection against mismatching. The pluggable installation connector is protected against ingress by solid objects in accordance with protection type IP20 (When mated and secured with a strain relief housing: IP2xC (These compact connectors are not designed for use in open, easily accessible areas!)). Thanks to the color coding and mechanical A coding of *WINSTA*[®] MIDI pluggable installation connectors, you can clearly distinguish different circuits. This pluggable installation connector can be used for electrical currents up to 25 A. Thus the product is especially suitable for high power loads. *WINSTA*[®] MIDI with Push-in CAGE CLAMP[®] spring pressure connection technology is used in can be found in a variety of projects you can use for quick, easy, flexible, and secure installation. The strip length is 35 mm.

Subject to changes. Please also observe the further product documentation!



WINSTA® MIDI solutions for your electrical installation – protected against mismatching and maintenance-free

WINSTA® is the pluggable connection system that is ideally tailored to the strict requirements of electrical installation. It allows fast, secure and, above all, error-free installation of components and cables. Choose durability and quality – with protection type IP20 from WAGO makes the installation of electrical components noticeably easier.

- pluggable installation connectors with protection against mismatching
- pre-assembled versions
- with A coding for use in many general mains applications
- flexible installation to save space
- quick replacement of defective units during ongoing operation

Data

Electrical data

Ratings per IEC/EN

Ratings per	IEC/EN 60664-1
Nominal voltage (III/3)	250 V
Rated impulse voltage (III/3)	4 kV
Rated current	25 A
Legend (ratings)	(III / 3) ≙ Overvoltage category III / Pollution degree 3

Ratings per UL 1977

Note for the US market	Some versions may also be used for current interruption in accordance with the UL certificate in select applications with currents below 16 A and voltages up to 600 V. For further information, please contact your local sales office.
Rated voltage (UL 1977)	600 V
Rated current UL 1977	23 A

General information

Note on contact resistance	approx. 1 mΩ of contact resistance approx. 0.25 mΩ contact transition plug/socket
----------------------------	--

Connection data

Connection points	4
-------------------	---

Subject to changes. Please also observe the further product documentation!

WAGO GmbH & Co. KG
 Hansastr. 27
 32423 Minden
 Phone: +49571 887-0 | Fax: +49571 887-169
 Email: info.de@wago.com | Web: www.wago.com

Do you have any questions about our products?
 We are always happy to take your call at +49 (571) 887-44222.



Total number of potentials	2
----------------------------	---

Connection 1

Connection technology	Push-in CAGE CLAMP®
Actuation type	Operating tool Push-in
Nominal cross-section	4 mm ² / 12 AWG
Solid conductor	0.5 ... 4 mm ² / 20 ... 12 AWG
Solid conductor; push-in termination	1.5 ... 4 mm ² / 16 ... 12 AWG
Stranded conductor	0.5 ... 2.5 mm ² / 20 ... 14 AWG
Fine-stranded conductor	0.5 ... 4 mm ² / 20 ... 12 AWG
Fine-stranded conductor; with insulated ferrule	0.25 ... 1.5 mm ² / 20 ... 16 AWG
Fine-stranded conductor; with uninsulated ferrule	0.25 ... 2.5 mm ² / 20 ... 14 AWG
Fine-stranded conductor; with ferrule; push-in termination	1.5 mm ² / 16 AWG
Strip length	9 mm / 0.35 inches
Pole number	2
Conductor entry direction to mating direction	0°
Strip length (outer insulation)	35 mm

Physical data

Pin spacing	10 mm / 0.394 inches
Width	24.6 mm / 0.969 inches
Height	15.9 mm / 0.626 inches
Depth	71 mm / 2.795 inches

Mechanical Data

Application	General mains applications
Coding	A
Variable coding	No
Marking	N L
Potential marking	N L
Mating force of a plug-in connection	approx. 20 ... 70 N (depending on pole number)
Retention force of a plug-in connection	Locked: > 80 N
Unmating force of a plug-in connection	Unlocked: approx. 20 ... 70 N (depending on pole number)
Number of mating cycles	200, without resistive load
Protection type	IP20; When mated and secured with a strain relief housing: IP2xC (These compact connectors are not designed for use in open, easily)

Subject to changes. Please also observe the further product documentation!



accessible areas!)

Plug-in connection

Contact type (pluggable connector)	Male connector/plug
Connector (connection type)	for conductor
Mismating protection	Yes
Note on mismating protection	All <i>WINSTA</i> [®] components are 100% protected against mismating when: a.) plugging different numbers of poles b.) plugging while rotated 180 c.) plugging while laterally staggered d.) plugging one pole
Locking lever	Can be retrofitted
Locking of plug-in connection	locking lever
Note on locking system	All connectors for mounted installations (snap-in versions for lighting fixtures or devices, all types of PCB and distribution connectors) are factory-equipped with locking levers to ensure plugs and sockets are securely locked. Additional locking levers are only required for flying leads (plug/socket).
Strain relief	strain relief housing

Material data

Note (material data)	Information on material specifications can be found here
Color	black
Cover color	gray
Material group	I
Insulation material	Polyamide (PA66)
Flammability class per UL94	V0
Clamping spring material	Chrome-nickel spring steel (CrNi)
Contact material	Copper or copper alloy; surface-treated
Contact plating	Tin
Fire load	0.405 MJ
Weight	12.9 g

Environmental requirements

Processing temperature	-5 ... +40 °C
Continuous operating temperature	-35 ... +85 °C

Subject to changes. Please also observe the further product documentation!

WAGO GmbH & Co. KG
Hansastr. 27
32423 Minden
Phone: +49571 887-0 | Fax: +49571 887-169
Email: info.de@wago.com | Web: www.wago.com

Do you have any questions about our products?
We are always happy to take your call at +49 (571) 887-44222.

Note on continuous operating temperature

Insulating parts for temperatures $\leq 105\text{ }^{\circ}\text{C}$

Commercial data

eCl@ss 10.0	27-44-06-05
eCl@ss 9.0	27-44-06-05
ETIM 8.0	EC002560
ETIM 7.0	EC002560
ECCN	NO DATA
PU (SPU)	25 pcs
Packaging type	box
Country of origin	DE
GTIN	4050821117940
Customs tariff number	85366990990



Environmental Product Compliance

RoHS Compliance Status

Compliant, No Exemption

Approvals / Certificates

General approvals

Logo	Approval	Additional Approval Text	Certificate name
	CCA DEKRA Certification B.V.	EN 61535	71-123228
	CCA DEKRA Certification B.V.	IEC 61535	NL -84761
	cURus Underwriters Laboratories Inc.	UL 1977	E45171
	cURus Underwriters Laboratories Inc.	UL 1059	E 45172

Declarations of conformity and manufacturer's declarations

Logo	Approval	Additional Approval Text	Certificate name
	EU-Declaration of Conformity	-	-

Subject to changes. Please also observe the further product documentation!

WAGO GmbH & Co. KG

Hansastr. 27

32423 Minden

Phone: +49571 887-0 | Fax: +49571 887-169

Email: info.de@wago.com | Web: www.wago.com



Do you have any questions about our products?

We are always happy to take your call at +49 (571) 887-44222.









WAGO GmbH & Co. KG

Approvals for marine applications

Logo	Approval	Additional Approval Text	Certificate name
	ABS American Bureau of Shipping	-	19- HG1868589- PDA
	DNV GL Det Norske Veritas, Germanischer Lloyd	-	TAE00001Z6
	LR Lloyds Register	IEC 61984	LR22429487TA

Counterpart

	Item no.770-1606 T-distribution connector; 2-pole; Cod. A; 1 input; 2 outputs; 2 locking levers; black	www.wago.com/770-1606
	Item no.770-102/041-000 Socket; with strain relief housing; 2-pole; Cod. A; 4,00 mm ² ; black	www.wago.com/770-102/041-000
	Item no.770-1615 T-distribution connector; 2-pole; Cod. A; 1 input; 2 outputs; 3 locking levers; for flying leads; black	www.wago.com/770-1615
	Item no.770-1634 h-distribution connector; 2-pole; Cod. A; 1 input; 2 outputs; outputs on one side; 2 locking levers; black	www.wago.com/770-1634
	Item no.770-1636 h-distribution connector; 2-pole; Cod. A; 1 input; 2 outputs; outputs on one side; 3 locking levers; for flying leads; black	www.wago.com/770-1636
	Item no.770-202 Socket; 2-pole; Cod. A; 4,00 mm ² ; black	www.wago.com/770-202
	Item no.771-8992/006-101 pre-assembled interconnecting cable; Eca; Socket/plug; 2-pole; Cod. A; H05VV-F 2 x 1.5 mm ² ; 1 m; 1,50 mm ² ; black	www.wago.com/771-8992/006-101

Subject to changes. Please also observe the further product documentation!

WAGO GmbH & Co. KG
 Hansastr. 27
 32423 Minden
 Phone: +49571 887-0 | Fax: +49571 887-169
 Email: info.de@wago.com | Web: www.wago.com

Do you have any questions about our products?
 We are always happy to take your call at +49 (571) 887-44222.



Item no. 771-8992/106-101

pre-assembled connecting cable; Eca; Socket/open-ended; 2-pole; Cod. A; H05VV-F 2 x 1.5 mm²; 1 m; 1,50 mm²; black

www.wago.com/771-8992/106-101

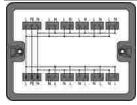

Item no. 899-631/477-000

Distribution box; Single-phase current (230 V); 1 input; 11 outputs; Cod. A; MIDI; black

www.wago.com/899-631/477-000

Required accessories

Locking levers

Locking system



Item no.: 770-121

Locking lever; for flying leads; for manual operation; white

www.wago.com/770-121



Item no.: 770-131

Locking lever; for flying leads; for tool operation; white

www.wago.com/770-131



Item no.: 770-101

Locking lever; for flying leads; for manual operation; black

www.wago.com/770-101



Item no.: 770-111

Locking lever; for flying leads; for tool operation; black

www.wago.com/770-111

Optional accessories

Cover

Cover



Item no.: 770-360

Lockout cap; for plugs; 5-pole; separable; yellow

www.wago.com/770-360



Item no.: 897-2003

Protective cap; Type2; for sockets and plugs; PVC; red

www.wago.com/897-2003

Tool

Operating tool



Item no.: 210-719

Operating tool; Blade: 2.5 x 0.4 mm; with a partially insulated shaft

www.wago.com/210-719



Item no.: 770-382

Operating tool; 2-way; green

www.wago.com/770-382

Subject to changes. Please also observe the further product documentation!

WAGO GmbH & Co. KG

Hansastr. 27

32423 Minden

Phone: +49571 887-0 | Fax: +49571 887-169

Email: info.de@wago.com | Web: www.wago.com

Do you have any questions about our products?

We are always happy to take your call at +49 (571) 887-44222.



Downloads

Documentation

Bid Text

770-112/041-000 X81 - Datei	2019 Feb 19	xml 3.1 kB	Download
--------------------------------	-------------	---------------	----------

770-112/041-000 doc - Datei	2015 Jun 8	doc 24.1 kB	Download
--------------------------------	------------	----------------	----------

CAD/CAE-Data

CAD data

2D/3D Models 770-112/041-000		URL	Download
------------------------------	--	-----	----------

CAE data

WSCAD Universe 770-112/041-000		URL	Download
--------------------------------	--	-----	----------

ZUKEN Portal 770-112/041-000		URL	Download
------------------------------	--	-----	----------

WSCAD Universe 770-112/041-000		URL	Download
--------------------------------	--	-----	----------

Asset Administration Shell

Asset Administration Shell 770-112/041-000		URL	Download
--	--	-----	----------

Environmental Product Compliance

Compliance Search

Environmental Product Compliance 770-112/041-000 Plug; with strain relief housing; 2-pole; Cod. A; 4,00 mm ² ; black		URL	Download
--	--	-----	----------

Installation Notes

Conductor termination

Subject to changes. Please also observe the further product documentation!

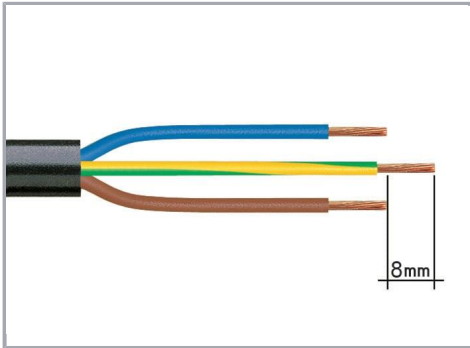

1. Strip length, outer insulation = 35 mm (2-pole), 55 mm (3- to 5-pole)
2. Strip length = 9 mm
3. Extended ground conductor = 8 mm

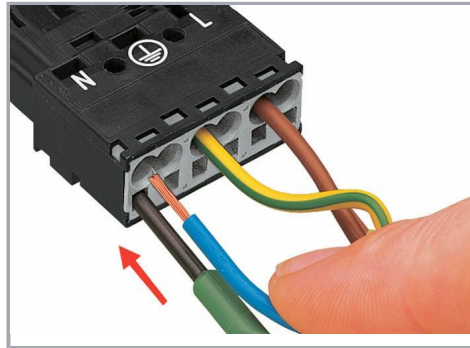

To terminate fine-stranded conductors, open the clamping unit via screwdriver (2.5 mm blade width) and insert a stripped conductor until it hits the backstop.

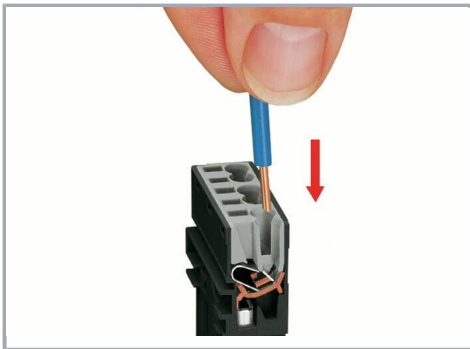

Insert the stripped solid conductor until it hits the backstop.

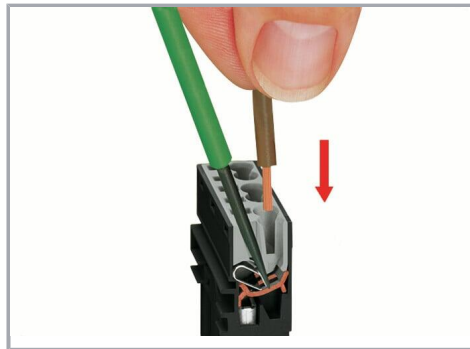

To terminate fine-stranded conductors, open the clamping unit via screwdriver (2.5 mm blade width) and insert a stripped conductor until it hits the backstop.

Conductor removal

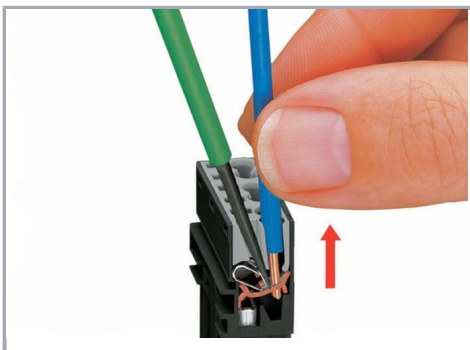

To remove the conductor, actuate the clamp via screwdriver (2.5 mm blade width) and pull out the conductor.

Subject to changes. Please also observe the further product documentation!

Installation

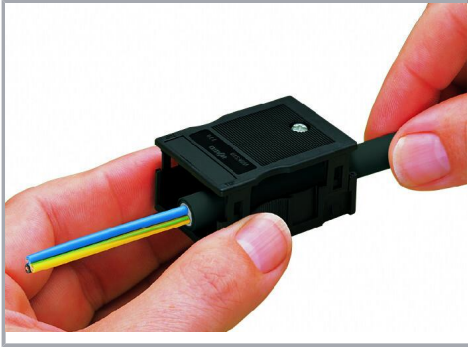

We recommend pulling the pre-latched strain relief housing over the cable prior to termination. However, the strain relief can be mounted at a later time as well.



Latch the strain relief housing onto the plug /socket. Note the "TOP" inscription.

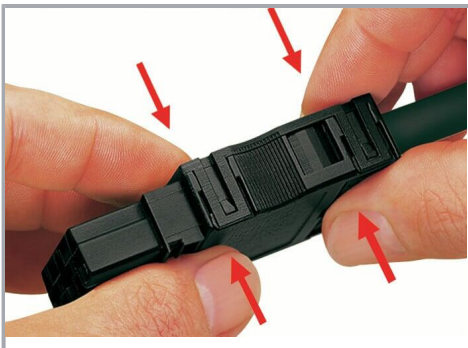

Prepare strain relief housing by snapping together upper and bottom part.



Tighten strain relief screw with screwdriver (2.5 mm blade width).

Product family

WINSTA® MIDI

[Show all products from the family](#)

Subject to changes. Please also observe the further product documentation!