

Data sheet | Item number: 890-753

Snap-in plug; 3-pole; Cod. B; 1,50 mm²; gray

www.wago.com/890-753

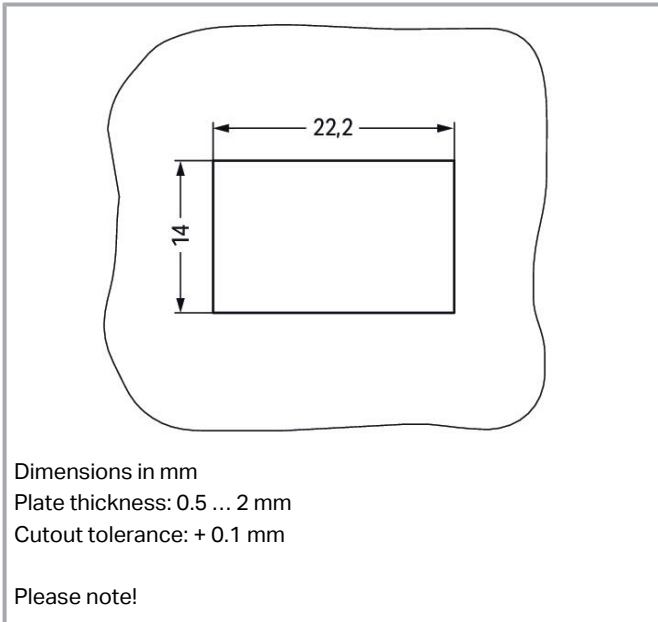
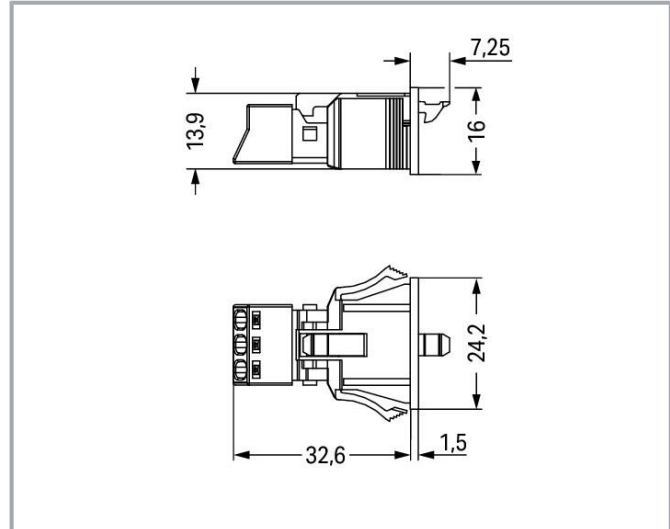
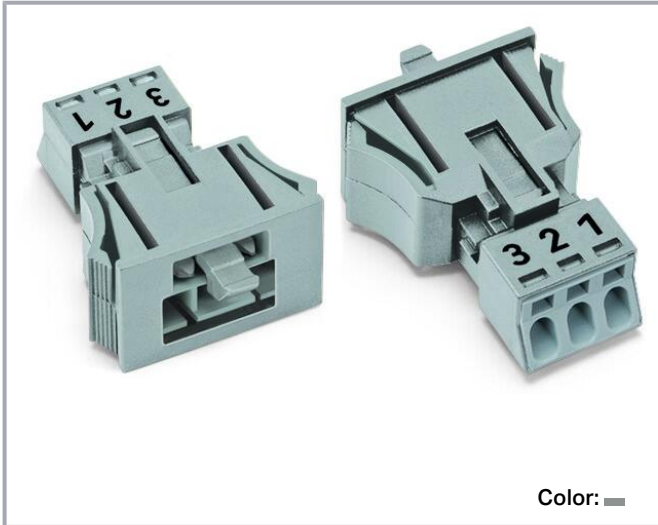

Subject to changes. Please also observe the further product documentation!

WAGO GmbH & Co. KG
Hansastr. 27
32423 Minden
Phone: +49571 887-0 | Fax: +49571 887-169
Email: info.de@wago.com | Web: www.wago.com

Do you have any questions about our products?
We are always happy to take your call at +49 (571) 887-44222.



Item description

Male connector/plug *WINSTA*® MINI 3-pole

Use effective pluggable connections instead of laborious screw connections: With the *WINSTA*® MINI male connector/plug with protection against mismatching. Whether on PCBs, in control cabinets or for connecting lights – pluggable installation connectors from WAGO allow you to establish connections according to a huge variety of requirements in seconds. For greater protection in electrical installations, the pluggable installation connector is provided with mechanical protection against mismatching. Solutions like the *WINSTA*® MINI pluggable installation connectors with B coding are suitable for process control, such as for lighting or within data networks. Especially where space is tight, our smallest pluggable connection system, *WINSTA*® MINI, consistently displays its strengths. It saves space, and, thanks to Push-in CAGE CLAMP® spring pressure connection technology, it additionally saves time, since the installation is low-maintenance and can be performed without screw connections.

Lower costs through fast commissioning and elimination of service expenses – solutions from *WINSTA*® MINI

The *WINSTA*® Pluggable Connection System is perfectly tailored to the strict requirements of building installation. It makes electrical installation pluggable, and consequently more efficient, more reliable, and error-free. Use of this pre-assembled system reduces assembly times and installation errors at the construction site. Choose durability and quality – with protection type IP20 from WAGO makes the electrical installation of electrical components noticeably easier.

-
- pluggable installation connectors with protection against mismatching
- easy tool-free operation, a wide range of coding options
- with B coding for controllers such as sun blinds and lighting fixtures
- flexible installation to save space
- convenient installation and commissioning

Data

Notes

Note	<p>The snap-in connectors must be relieved of tensile and transverse forces.</p> <p>A surface finish can influence the edge radius of the cutouts. This may affect the snap-in socket fit, so ensure an adequate fit before use. In addition, the punched edge should be on the inside for punched cutouts.</p> <p>The wings of the snap-in connectors must not be mechanically stressed for a long period before use (e.g., due to a pre-locking position).</p>
------	--

Subject to changes. Please also observe the further product documentation!

WAGO GmbH & Co. KG
Hansastr. 27
32423 Minden
Phone: +49571 887-0 | Fax: +49571 887-169
Email: info.de@wago.com | Web: www.wago.com

Do you have any questions about our products?
We are always happy to take your call at +49 (571) 887-44222.

Variants:

Other pole markings

Other versions (or variants) can be requested from WAGO Sales or configured at <https://configurator.wago.com/>.

Electrical data

Ratings per IEC/EN

Ratings per	IEC/EN 60664-1
Nominal voltage (III/3)	250 V
Rated impulse voltage (III/3)	4 kV
Rated current	16 A
Legend (ratings)	(III / 3) ≙ Overvoltage category III / Pollution degree 3

Ratings per IEC/EN – Notes

Note (rated current)	13 A for 3-pole load
----------------------	----------------------

Ratings per UL 1977

Note for the US market	Some versions may also be used for current interruption in accordance with the UL certificate in select applications with currents below 5 A and voltages up to 600 V. For further information, please contact your local sales office.
Rated voltage (UL 1977)	600 V
Rated current UL 1977	14 A

General information

Note on contact resistance	approx. 1 mΩ of contact resistance approx. 0.25 mΩ contact transition plug/socket
----------------------------	--

Connection data

Connection points	3
Total number of potentials	3

Connection 1

Connection technology	Push-in CAGE CLAMP®
Actuation type	Operating tool Push-in
Nominal cross-section	1.5 mm ² / 16 AWG

Subject to changes. Please also observe the further product documentation!



Solid conductor	0.25 ... 1.5 mm ² / 22 ... 16 AWG
Solid conductor; push-in termination	0.75 ... 1.5 mm ² / 20 ... 16 AWG
Stranded conductor	0.25 ... 1 mm ² / 22 ... 18 AWG
Fine-stranded conductor	0.25 ... 1.5 mm ² / 22 ... 16 AWG
Fine-stranded conductor; with insulated ferrule	0.25 ... 0.75 mm ² / 22 ... 20 AWG
Fine-stranded conductor; with uninsulated ferrule	0.25 ... 0.75 mm ² / 22 ... 20 AWG
Fine-stranded conductor; with ferrule; push-in termination	0.75 mm ² / 20 AWG
Strip length	9 mm / 0.35 inches
Pole number	3
Conductor entry direction to mating direction	0°

Physical data

Pin spacing	4.4 mm / 0.173 inches
Width	24.2 mm / 0.953 inches
Height	16 mm / 0.63 inches
Depth	39.85 mm / 1.569 inches

Mechanical Data

Application	Control technology
Coding	B
Variable coding	No
Marking	3 2 1
Potential marking	3 2 1
Mating force of a plug-in connection	approx. 20 ... 70 N (depending on pole number)
Retention force of a plug-in connection	Locked: > 80 N
Unmating force of a plug-in connection	Unlocked: approx. 20 ... 70 N (depending on pole number)
Number of mating cycles	200, without resistive load
Housing sheet thickness	0.5 ... 2 mm / 0.02 ... 0.079 inches
Mounting type	Snap-in flange
Protection type	IP20; IP40 when mated

Plug-in connection

Contact type (pluggable connector)	Male connector/plug
Connector (connection type)	for conductor
Mismating protection	Yes
Note on mismating protection	All WINSTA [®] components are 100% protected against mismating when:

Subject to changes. Please also observe the further product documentation!



- a.) plugging different numbers of poles
- b.) plugging while rotated 180
- c.) plugging while laterally staggered
- d.) plugging one pole

Locking lever	yes
Locking of plug-in connection	locking lever
Note on locking system	All connectors for mounted installations (snap-in versions for lighting fixtures or devices, all types of PCB and distribution connectors) are factory-equipped with locking levers to ensure plugs and sockets are securely locked. Additional locking levers are only required for flying leads (plug/socket).

Material data

Note (material data)

Information on material specifications can be found here

Color	gray
Cover color	gray
Material group	I
Insulation material	Polyamide (PA66)
Flammability class per UL94	V0
Clamping spring material	Chrome-nickel spring steel (CrNi)
Contact material	Copper or copper alloy; surface-treated
Contact plating	Tin
Fire load	0.178 MJ
Weight	5.5 g

Environmental requirements

Processing temperature	-5 ... +40 °C
Continuous operating temperature	-35 ... +85 °C
Note on continuous operating temperature	Insulating parts for temperatures ≤ 105 °C

Commercial data

Product Group	20 (Winsta)
eCl@ss 10.0	27-44-06-02
eCl@ss 9.0	27-44-06-02
ETIM 8.0	EC002566
ETIM 7.0	EC002566
ECCN	NO DATA

Subject to changes. Please also observe the further product documentation!

WAGO GmbH & Co. KG
 Hansastr. 27
 32423 Minden
 Phone: +49571 887-0 | Fax: +49571 887-169
 Email: info.de@wago.com | Web: www.wago.com

Do you have any questions about our products?
 We are always happy to take your call at +49 (571) 887-44222.



PU (SPU)	50 (50) pcs
Packaging type	box
Country of origin	PL
GTIN	4055143427852
Customs tariff number	85366990990

Environmental Product Compliance



RoHS Compliance Status	Compliant, No Exemption
------------------------	-------------------------

Approvals / Certificates

General approvals

Logo	Approval	Additional Approval Text	Certificate name
	CB DEKRA Certification B.V.	IEC 61984	NL-64351
	CB DEKRA Certification B.V.	EN 61984	71-112993
	cURus Underwriters Laboratories Inc.	UL 1977	E45171
	KEMA/KEUR DEKRA Certification B.V.	EN 60320	2148952.04



Declarations of conformity and manufacturer's declarations

Logo	Approval	Additional Approval Text	Certificate name
	EU-Declaration of Conformity WAGO GmbH & Co. KG	-	-
	UK-Declaration of Conformity WAGO GmbH & Co. KG	-	-



Approvals for marine applications

Certificate

Subject to changes. Please also observe the further product documentation!

Logo	Approval	Additional Approval Text	name
	DNV GL Det Norske Veritas, Germanischer Lloyd	-	TAE00001Z6
	LR Lloyds Register	EN 61535	08/20047 (E2)



Counterpart

	Item no.890-243 Socket; 3-pole; Cod. B; 1,50 mm ² ; gray	www.wago.com/890-243
	Item no.891-8993/005-103 pre-assembled interconnecting cable; Eca; Socket/plug; 3-pole; Cod. B; 1 m; 1,00 mm ² ; gray	www.wago.com/891-8993/005-103
	Item no.891-8993/105-103 pre-assembled connecting cable; Eca; Socket/open-ended; 3-pole; Cod. B; 1 m; 1,00 mm ² ; gray	www.wago.com/891-8993/105-103

Optional accessories



Cover

Cover

	Item no.: 890-643 Lockout cap; 3-pole; for cutouts; Plastic; black	www.wago.com/890-643
	Item no.: 890-693 Lockout cap; 3-pole; for cutouts; Plastic; white	www.wago.com/890-693

Tool

Operating tool

	Item no.: 210-719 Operating tool; Blade: 2.5 x 0.4 mm; with a partially insulated shaft	www.wago.com/210-719
	Item no.: 890-383 Operating tool; 3-way; green	www.wago.com/890-383

Downloads

Documentation

Subject to changes. Please also observe the further product documentation!



Bid Text

890-753 X81 - Datei	2019 Feb 19	xml 3.0 kB	Download
890-753 doc - Datei	2018 Nov 30	doc 23.6 kB	Download

CAD/CAE-Data

CAD data

2D/3D Models 890-753	URL	Download
----------------------	-----	----------

CAE data

EPLAN Data Portal 890-753	URL	Download
ZUKEN Portal 890-753	URL	Download
WSCAD Universe 890-753	URL	Download

Asset Administration Shell

Asset Administration Shell 890-753	URL	Download
------------------------------------	-----	----------

Environmental Product Compliance

Compliance Search

Environmental Product Compliance 890-753 Snap-in plug; 3-pole; Cod. B; 1,50 mm ² ; gray	URL	Download
---	-----	----------

Installation Notes

Conductor termination

Subject to changes. Please also observe the further product documentation!

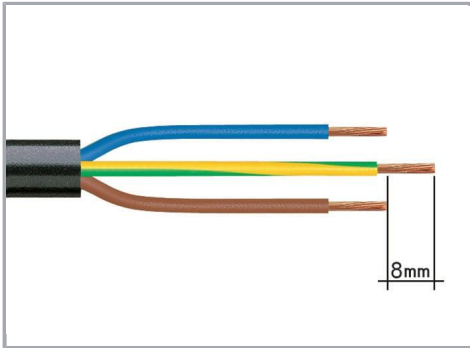

1. Strip length, outer insulation = 30 mm (2-pole), 37 mm (3-pole), 45 mm (4- and 5-pole)
2. Strip length = 9 mm
3. Extended ground conductor = 8 mm

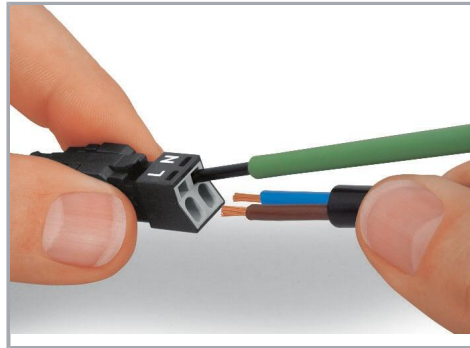

To terminate fine-stranded conductors, open the clamping unit via screwdriver – 2.5 mm blade width – and insert a stripped conductor until it hits the backstop. Terminate solid conductors by simply pushing them in.

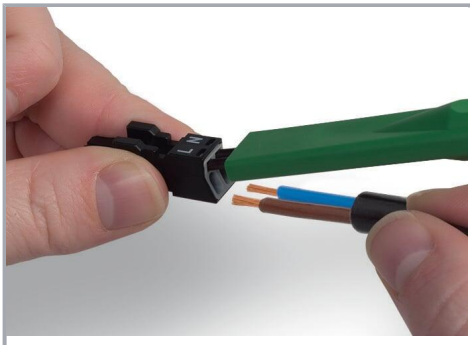

To terminate fine-stranded conductors, open clamping units via operating tool (890-382) and insert stripped conductors until they hit backstop. Terminate solid conductors by simply pushing them in.

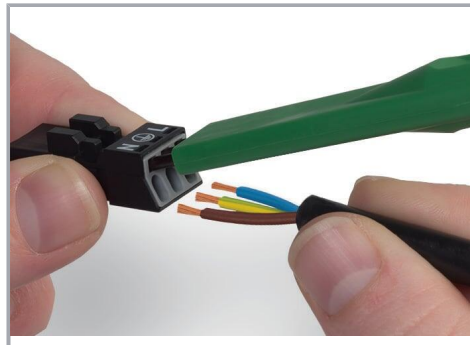

To terminate fine-stranded conductors, open clamping units via operating tool (890-383) and insert stripped conductors until they hit backstop. Terminate solid conductors by simply pushing them in.

Mismatching protection

Subject to changes. Please also observe the further product documentation!

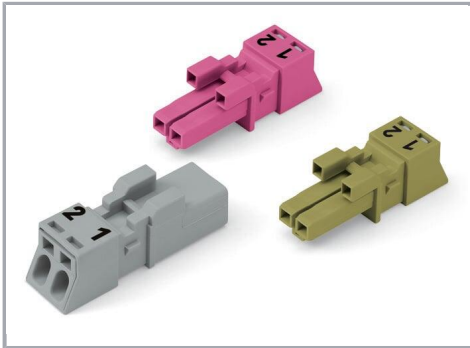

B-coded connectors with different colors can be plugged together.

Important note:

Different colors and/or pole markings are used for circuit identification.

Only connectors of the same color and same pole marking must be plugged together.

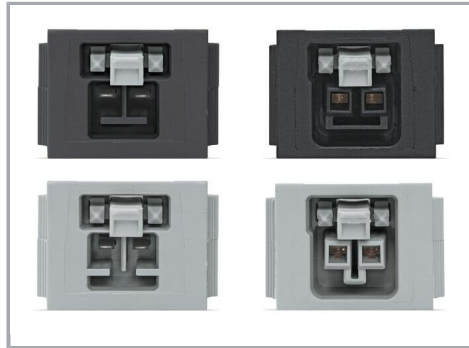

B-coded connectors (shown in gray) not only differ in color, but also in their design, making them incompatible with other coded connectors.



Product family

WINSTA® MINI

[Show all products from the family](#)

Subject to changes. Please also observe the further product documentation!