

Data sheet | Item number: 890-793

Snap-in plug; 3-pole; Cod. B; 1,50 mm<sup>2</sup>; pink

[www.wago.com/890-793](http://www.wago.com/890-793)

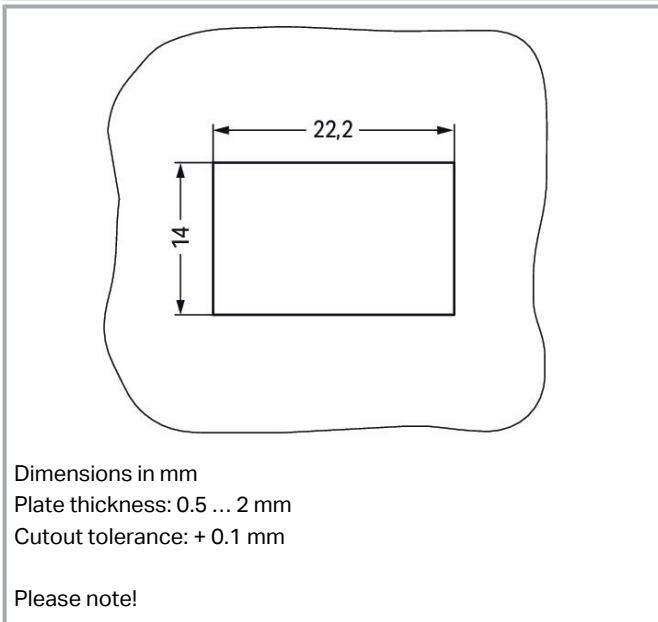
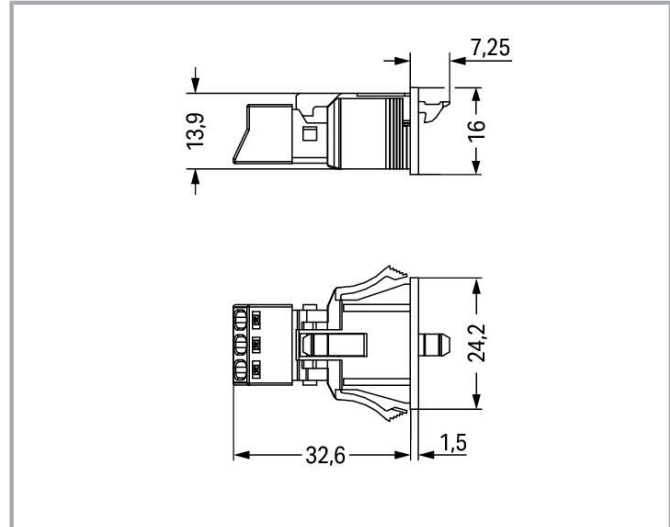
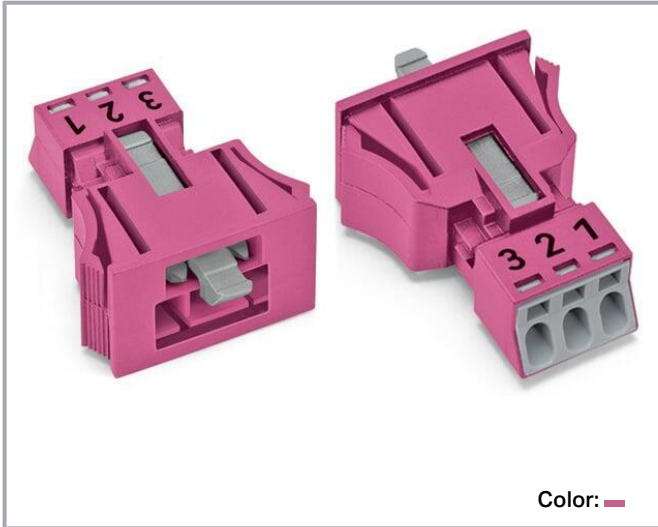

Dimensions in mm  
Plate thickness: 0.5 ... 2 mm  
Cutout tolerance: + 0.1 mm

Please note!

Subject to changes. Please also observe the further product documentation!

WAGO GmbH & Co. KG  
Hansastr. 27  
32423 Minden  
Phone: +49571 887-0 | Fax: +49571 887-169  
Email: [info.de@wago.com](mailto:info.de@wago.com) | Web: [www.wago.com](http://www.wago.com)

Do you have any questions about our products?  
We are always happy to take your call at +49 (571) 887-44222.



## Item description

### Male connector/plug *WINSTA*® MINI B coding

Use effective pluggable connections instead of laborious screw connections: With the *WINSTA*® MINI male connector/plug with protection against mismatching. On PCBs, in control cabinets or for connecting lights – pluggable installation connectors from WAGO allow you to establish connections according to an enormous variety of requirements in next to no time. The color coding and mechanical coding of the pluggable installation connector ensure error-free installation of the individual components – including protection against mismatching. Pluggable installation connectors with B coding from the *WINSTA*® MINI line are available in gray, light green, or pink, allowing you to distinguish different circuits, for example for light, pumps or, sun blinds. Usage-specific pole marking is possible, too. Particularly if only limited space is available, our smallest pluggable connection system, *WINSTA*® MINI, conveniently displays its advantageous properties. It is very compact, and, with Push-in CAGE CLAMP® spring pressure connection technology, it also saves time, since the connection is low-maintenance and can be performed without screw connections.

### Push-in CAGE CLAMP® spring pressure connection technology – pluggable installation instead of laborious screw connections!

The *WINSTA*® Pluggable Connection System allows pluggable electrical installation. This saves time, lowers costs, and reduces the need for servicing. Enjoy the benefits of the pluggable version of our maintenance-free spring pressure connection technology too! Plan your installation with with marking from WAGO.

- 
- protection against mismatching eliminates errors
- consistent IP40 protection
- for automation controllers
- custom-engineered solutions
- quick replacement of defective units during ongoing operation

## Data

### Notes

Note	<p>The snap-in connectors must be relieved of tensile and transverse forces.</p> <p>A surface finish can influence the edge radius of the cutouts. This may affect the snap-in socket fit, so ensure an adequate fit before use. In addition, the punched edge should be on the inside for punched cutouts.</p> <p>The wings of the snap-in connectors must not be mechanically stressed for a long period before use (e.g., due to a pre-locking position).</p>
------	--

---

Subject to changes. Please also observe the further product documentation!

---

WAGO GmbH & Co. KG  
Hansastr. 27  
32423 Minden  
Phone: +49571 887-0 | Fax: +49571 887-169  
Email: [info.de@wago.com](mailto:info.de@wago.com) | Web: [www.wago.com](http://www.wago.com)

Do you have any questions about our products?  
We are always happy to take your call at +49 (571) 887-44222.



Variants:

Other pole markings

Other versions (or variants) can be requested from WAGO Sales or configured at <https://configurator.wago.com/>.

## Electrical data

### Ratings per IEC/EN

Ratings per	IEC/EN 60664-1
Nominal voltage (III/3)	250 V
Rated impulse voltage (III/3)	4 kV
Rated current	16 A
Legend (ratings)	(III / 3) $\triangleq$ Overvoltage category III / Pollution degree 3

### Ratings per IEC/EN – Notes

Note (rated current)	13 A for 3-pole load
----------------------	----------------------

### Ratings per UL 1977

Note for the US market	Some versions may also be used for current interruption in accordance with the UL certificate in select applications with currents below 5 A and voltages up to 600 V. For further information, please contact your local sales office.
Rated voltage (UL 1977)	600 V
Rated current UL 1977	14 A

## General information

Note on contact resistance	approx. 1 m $\Omega$ of contact resistance approx. 0.25 m $\Omega$ contact transition plug/socket
----------------------------	--

## Connection data

Connection points	3
Total number of potentials	3

### Connection 1

Connection technology	Push-in CAGE CLAMP <sup>®</sup>
Actuation type	Operating tool Push-in
Nominal cross-section	1.5 mm <sup>2</sup> / 16 AWG

Subject to changes. Please also observe the further product documentation!



Solid conductor	0.25 ... 1.5 mm <sup>2</sup> / 22 ... 16 AWG
Solid conductor; push-in termination	0.75 ... 1.5 mm <sup>2</sup> / 20 ... 16 AWG
Stranded conductor	0.25 ... 1 mm <sup>2</sup> / 22 ... 18 AWG
Fine-stranded conductor	0.25 ... 1.5 mm <sup>2</sup> / 22 ... 16 AWG
Fine-stranded conductor; with insulated ferrule	0.25 ... 0.75 mm <sup>2</sup> / 22 ... 20 AWG
Fine-stranded conductor; with uninsulated ferrule	0.25 ... 0.75 mm <sup>2</sup> / 22 ... 20 AWG
Fine-stranded conductor; with ferrule; push-in termination	0.75 mm <sup>2</sup> / 20 AWG
Strip length	9 mm / 0.35 inches
Pole number	3
Conductor entry direction to mating direction	0°

### Physical data

Pin spacing	4.4 mm / 0.173 inches
Width	24.2 mm / 0.953 inches
Height	16 mm / 0.63 inches
Depth	39.85 mm / 1.569 inches

### Mechanical Data

Application	Control technology
Coding	B
Variable coding	No
Marking	3 2 1
Potential marking	3 2 1
Mating force of a plug-in connection	approx. 20 ... 70 N (depending on pole number)
Retention force of a plug-in connection	Locked: > 80 N
Unmating force of a plug-in connection	Unlocked: approx. 20 ... 70 N (depending on pole number)
Number of mating cycles	200, without resistive load
Housing sheet thickness	0.5 ... 2 mm / 0.02 ... 0.079 inches
Mounting type	Snap-in flange
Protection type	IP20; IP40 when mated

### Plug-in connection

Contact type (pluggable connector)	Male connector/plug
Connector (connection type)	for conductor
Mismating protection	Yes
Note on mismating protection	All WINSTA <sup>®</sup> components are 100% protected against mismating when:

Subject to changes. Please also observe the further product documentation!



- a.) plugging different numbers of poles
- b.) plugging while rotated 180
- c.) plugging while laterally staggered
- d.) plugging one pole

Locking lever	yes
Locking of plug-in connection	locking lever
Note on locking system	All connectors for mounted installations (snap-in versions for lighting fixtures or devices, all types of PCB and distribution connectors) are factory-equipped with locking levers to ensure plugs and sockets are securely locked. Additional locking levers are only required for flying leads (plug/socket).

## Material data

Note (material data)

Information on material specifications can be found here

Color	pink
Cover color	gray
Material group	I
Insulation material	Polyamide (PA66)
Flammability class per UL94	V0
Clamping spring material	Chrome-nickel spring steel (CrNi)
Contact material	Copper or copper alloy; surface-treated
Contact plating	Tin
Fire load	0.154 MJ
Weight	5.5 g

## Environmental requirements

Processing temperature	-5 ... +40 °C
Continuous operating temperature	-35 ... +85 °C
Note on continuous operating temperature	Insulating parts for temperatures $\leq 105$ °C

## Commercial data

Product Group	20 (Winsta)
eCl@ss 10.0	27-44-06-02
eCl@ss 9.0	27-44-06-02
ETIM 8.0	EC002566
ETIM 7.0	EC002566
ECCN	NO DATA

Subject to changes. Please also observe the further product documentation!

WAGO GmbH & Co. KG  
 Hansastr. 27  
 32423 Minden  
 Phone: +49571 887-0 | Fax: +49571 887-169  
 Email: [info.de@wago.com](mailto:info.de@wago.com) | Web: [www.wago.com](http://www.wago.com)

Do you have any questions about our products?  
 We are always happy to take your call at +49 (571) 887-44222.



PU (SPU)	50 (50) pcs
Packaging type	box
Country of origin	PL
GTIN	4055143427777
Customs tariff number	85366990990

## Environmental Product Compliance



RoHS Compliance Status	Compliant, No Exemption
------------------------	-------------------------

## Approvals / Certificates

### General approvals

Logo	Approval	Additional Approval Text	Certificate name
	CB DEKRA Certification B.V.	IEC 61984	NL-64351
	CB DEKRA Certification B.V.	EN 61984	71-112993
	cURus Underwriters Laboratories Inc.	UL 1977	E45171
	KEMA/KEUR DEKRA Certification B.V.	EN 60320	2148952.04



### Declarations of conformity and manufacturer's declarations

Logo	Approval	Additional Approval Text	Certificate name
	EU-Declaration of Conformity WAGO GmbH & Co. KG	-	-
	UK-Declaration of Conformity WAGO GmbH & Co. KG	-	-



### Approvals for marine applications

Certificate

Subject to changes. Please also observe the further product documentation!

Logo	Approval	Additional Approval Text	name
	<b>DNV GL</b> Det Norske Veritas, Germanischer Lloyd	-	TAE00001Z6
	<b>LR</b> Lloyds Register	EN 61535	08/20047 (E2)



## Counterpart

	<b>Item no.890-283</b> Socket; 3-pole; Cod. B; 1,50 mm <sup>2</sup> ; pink	<a href="http://www.wago.com/890-283">www.wago.com/890-283</a>
	<b>Item no.891-8993/105-107</b> pre-assembled connecting cable; Eca; Socket/open-ended; 3-pole; Cod. B; 1 m; 1,00 mm <sup>2</sup> ; pink	<a href="http://www.wago.com/891-8993/105-107">www.wago.com/891-8993/105-107</a>
	<b>Item no.891-8993/005-107</b> pre-assembled interconnecting cable; Socket/plug; 3-pole; Cod. B; 1 m; 1,00 mm <sup>2</sup> ; pink	<a href="http://www.wago.com/891-8993/005-107">www.wago.com/891-8993/005-107</a>

## Optional accessories



### Cover

#### Cover

	<b>Item no.: 890-643</b> Lockout cap; 3-pole; for cutouts; Plastic; black	<a href="http://www.wago.com/890-643">www.wago.com/890-643</a>
	<b>Item no.: 890-693</b> Lockout cap; 3-pole; for cutouts; Plastic; white	<a href="http://www.wago.com/890-693">www.wago.com/890-693</a>

### Tool

#### Operating tool

	<b>Item no.: 210-719</b> Operating tool; Blade: 2.5 x 0.4 mm; with a partially insulated shaft	<a href="http://www.wago.com/210-719">www.wago.com/210-719</a>
	<b>Item no.: 890-383</b> Operating tool; 3-way; green	<a href="http://www.wago.com/890-383">www.wago.com/890-383</a>

## Downloads

### Documentation

Subject to changes. Please also observe the further product documentation!



### Bid Text

890-793 X81 - Datei	2019 Feb 19	xml 3.0 kB	Download
890-793 doc - Datei	2015 Jun 8	doc 24.1 kB	Download

### CAD/CAE-Data

#### CAD data

2D/3D Models 890-793	URL	Download
----------------------	-----	----------

#### CAE data

WSCAD Universe 890-793	URL	Download
ZUKEN Portal 890-793	URL	Download
EPLAN Data Portal 890-793	URL	Download

#### Asset Administration Shell

Asset Administration Shell 890-793	URL	Download
------------------------------------	-----	----------

### Environmental Product Compliance

#### Compliance Search

Environmental Product Compliance 890-793 Snap-in plug; 3-pole; Cod. B; 1,50 mm <sup>2</sup> ; pink	URL	Download
---	-----	----------

### Installation Notes

#### Conductor termination

Subject to changes. Please also observe the further product documentation!



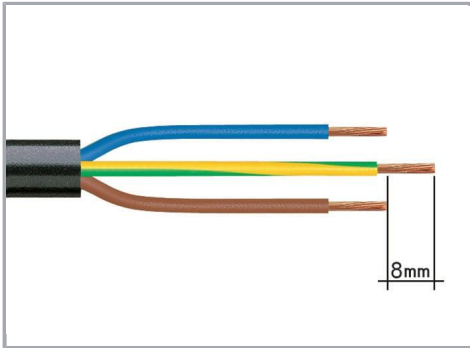

1. Strip length, outer insulation = 30 mm (2-pole), 37 mm (3-pole), 45 mm (4- and 5-pole)
2. Strip length = 9 mm
3. Extended ground conductor = 8 mm

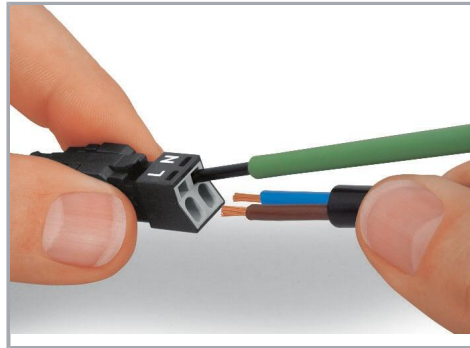

To terminate fine-stranded conductors, open the clamping unit via screwdriver – 2.5 mm blade width – and insert a stripped conductor until it hits the backstop. Terminate solid conductors by simply pushing them in.

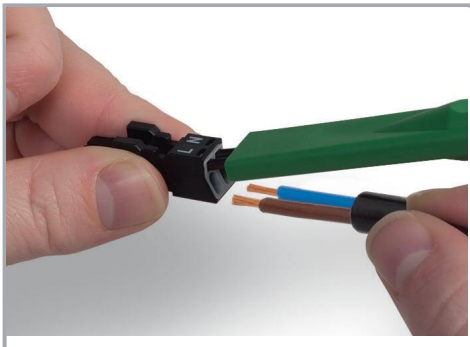

To terminate fine-stranded conductors, open clamping units via operating tool (890-382) and insert stripped conductors until they hit backstop. Terminate solid conductors by simply pushing them in.

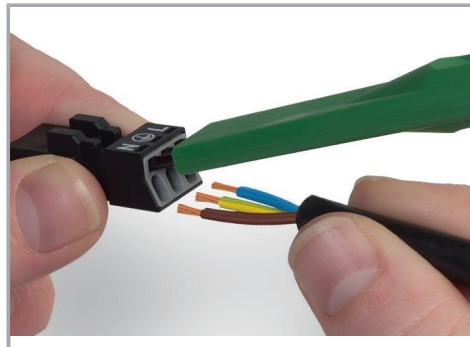

To terminate fine-stranded conductors, open clamping units via operating tool (890-383) and insert stripped conductors until they hit backstop. Terminate solid conductors by simply pushing them in.

#### Mismatching protection

Subject to changes. Please also observe the further product documentation!

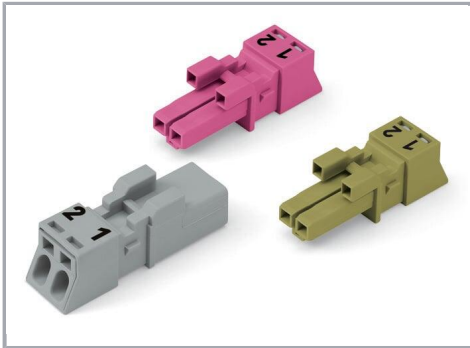

B-coded connectors with different colors can be plugged together.

**Important note:**

Different colors and/or pole markings are used for circuit identification.

Only connectors of the same color and same pole marking must be plugged together.

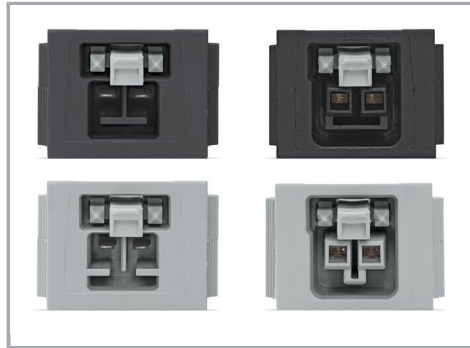

B-coded connectors (shown in gray) not only differ in color, but also in their design, making them incompatible with other coded connectors.



**Product family**

**WINSTA® MINI**

[Show all products from the family](#)

Subject to changes. Please also observe the further product documentation!