

**Data sheet | Item number: 831-1105/037-000**

1-conductor female connector; lever; Push-in CAGE CLAMP®; 10 mm²; Pin spacing 7.62 mm; 5-pole; 100% protected against mismatching; Lateral locking levers; 10,00 mm²; light gray

[www.wago.com/831-1105/037-000](http://www.wago.com/831-1105/037-000)

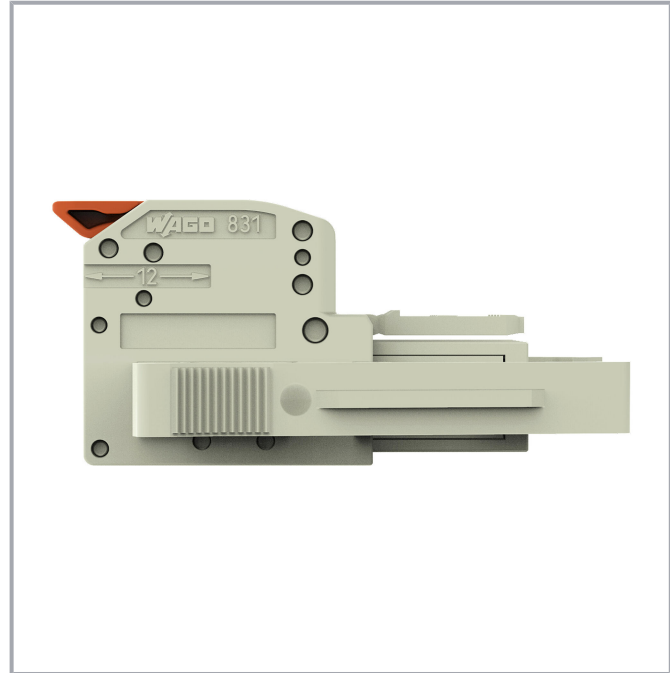
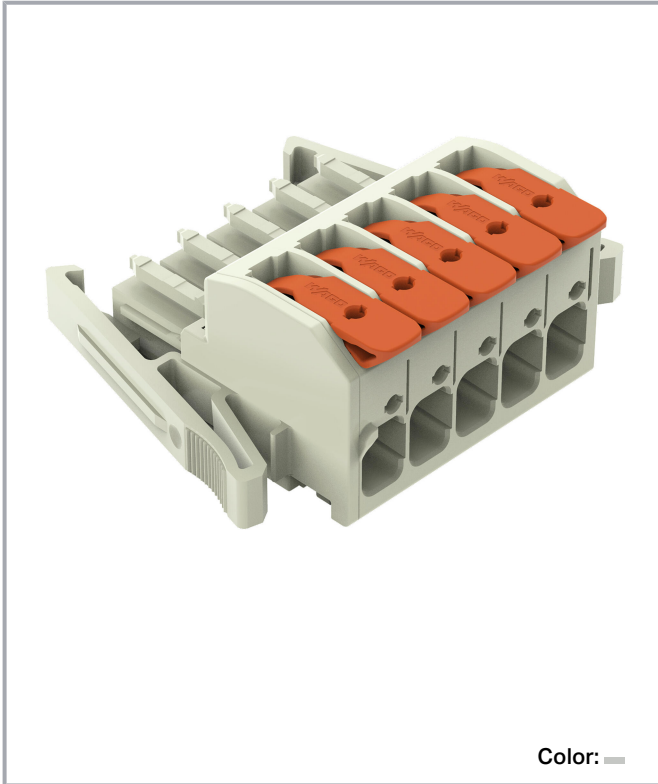

Subject to changes. Please also observe the further product documentation!

WAGO GmbH & Co. KG  
Hansastr. 27  
32423 Minden  
Phone: +49571 887-0 | Fax: +49571 887-169  
Email: [info.de@wago.com](mailto:info.de@wago.com) | Web: [www.wago.com](http://www.wago.com)

Do you have any questions about our products?  
We are always happy to take your call at +49 (571) 887-44222.



**Derating Curve**

1-conductor female connector (831-11xx) with  
1-conductor male connector (831-12xx)

Pin spacing: 7.62 mm / Conductor cross-section: 10 mm<sup>2</sup> "f-st"  
Based on: EN 60512-5-2 / Reduction factor: 0.8

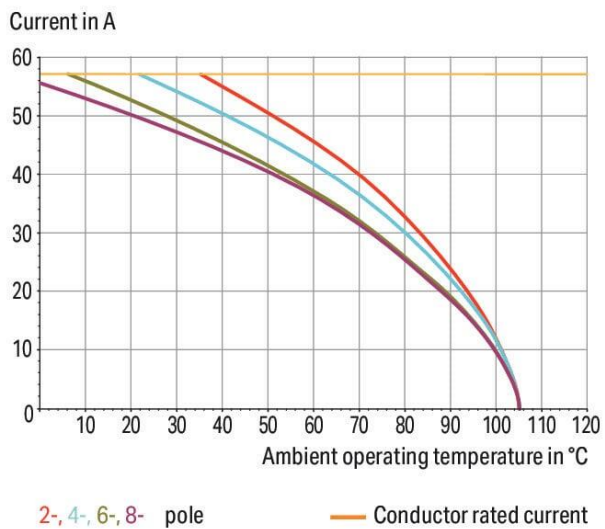

**Derating Curve**

1-conductor female connector (831-11xx) with  
THT male header (831-36xx)

Pin spacing: 7.62 mm / Conductor cross-section: 6 mm<sup>2</sup> "f-st"  
Based on: EN 60512-5-2 / Reduction factor: 0.8

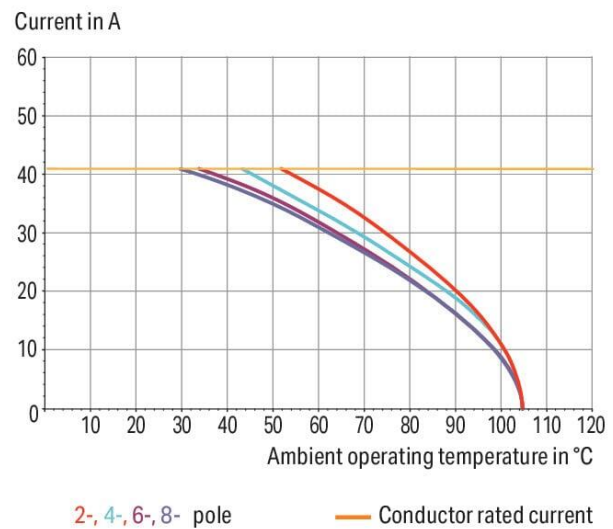

Subject to changes. Please also observe the further product documentation!

WAGO GmbH & Co. KG  
Hansastr. 27  
32423 Minden  
Phone: +49571 887-0 | Fax: +49571 887-169  
Email: [info.de@wago.com](mailto:info.de@wago.com) | Web: [www.wago.com](http://www.wago.com)

Do you have any questions about our products?  
We are always happy to take your call at +49 (571) 887-44222.

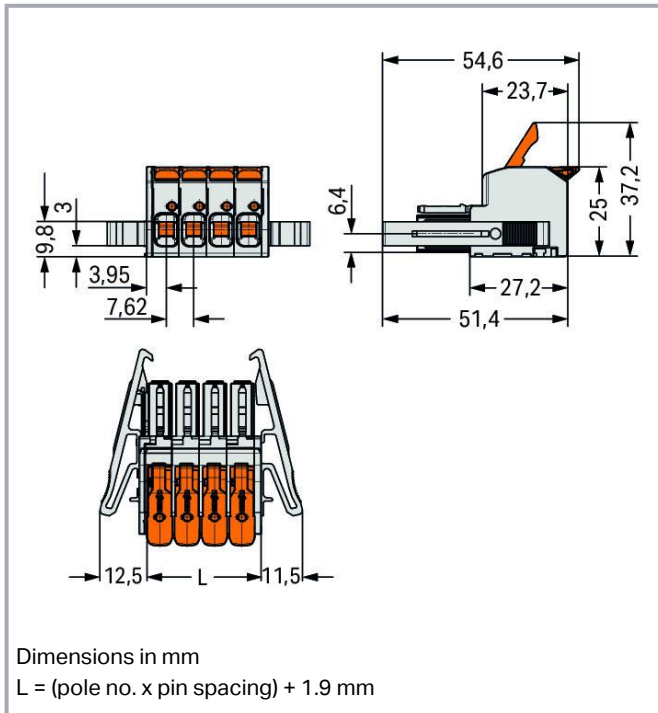

### Item description

- Intuitive and tool-free lever actuation
- Universal connection for all conductor types
- Push-in termination of solid and ferruled conductors
- Test slot 0° and 90° to conductor entry
- 100% protected against mismatching
- Coding option available

### Data

#### Notes

##### Safety information

The *MCS – MULTI CONNECTION SYSTEM* includes connectors without breaking capacity in accordance with DIN EN 61984. When used as intended, these connectors must not be connected /disconnected when live or under load. When used as intended, these connectors must not be connected/disconnected when live or under load. The circuit design should ensure header pins, which can be touched, are not live when unmated.

##### Variants:

Other colors

Other versions (or variants) can be requested from WAGO Sales or configured at <https://configurator.wago.com/>.

Subject to changes. Please also observe the further product documentation!

WAGO GmbH & Co. KG

Hansastr. 27

32423 Minden

Phone: +49571 887-0 | Fax: +49571 887-169

Email: [info.de@wago.com](mailto:info.de@wago.com) | Web: [www.wago.com](http://www.wago.com)

Do you have any questions about our products?

We are always happy to take your call at +49 (571) 887-44222.



## Electrical data

### Ratings per IEC/EN

Ratings per	IEC/EN 60664-1
Nominal voltage (III/3)	800 V
Rated impulse voltage (III/3)	8 kV
Rated voltage (III/2)	1000 V
Rated impulse voltage (III/2)	8 kV
Nominal voltage (II/2)	1000 V
Rated surge voltage (II/2)	8 kV
Rated current	41 A
Legend (ratings)	(III / 2) $\hat{=}$ Overvoltage category III / Pollution degree 2

### Ratings per UL

Approvals per	UL 1059
Rated voltage UL (Use Group C)	600 V
Rated current UL (Use Group C)	37 A
Rated voltage UL (Use Group D)	600 V
Rated current UL (Use Group D)	5 A

### Ratings per CSA

Approvals per	CSA
Rated voltage CSA (Use Group C)	600 V
Rated current CSA (Use Group C)	35 A
Rated voltage CSA (Use Group D)	600 V
Rated current CSA (Use Group D)	5 A

## Connection data

Total number of potentials	5
Number of connection types	1
Number of levels	1

### Connection 1

Connection technology	Push-in CAGE CLAMP <sup>®</sup>
Actuation type	Lever

Subject to changes. Please also observe the further product documentation!



Solid conductor	0.5 ... 10 mm <sup>2</sup> / 20 ... 8 AWG
Fine-stranded conductor	0.5 ... 10 mm <sup>2</sup> / 20 ... 8 AWG
Fine-stranded conductor; with insulated ferrule	0.5 ... 6 mm <sup>2</sup>
Fine-stranded conductor; with uninsulated ferrule	0.5 ... 6 mm <sup>2</sup>
Strip length	11 ... 13 mm / 0.43 ... 0.51 inches
Pole number	5
Conductor entry direction to mating direction	0°

### Physical data

Pin spacing	7.62 mm / 0.3 inches
Width	64 mm / 2.52 inches
Height	25 mm / 0.984 inches
Depth	54.6 mm / 2.150 inches

### Mechanical Data

Variable coding	Yes
Anti-rotation protection	Yes

### Plug-in connection

Contact type (pluggable connector)	Female connector/socket
Connector (connection type)	for conductor
Mismating protection	Yes
Plugging without loss of pin spacing	No
Locking of plug-in connection	Locking lever

### Material data

Note (material data)	Information on material specifications can be found here
Color	light gray
Material group	I
Insulation material	Polyamide (PA66)
Flammability class per UL94	V0
Clamping spring material	Chrome-nickel spring steel (CrNi)
Contact material	Electrolytic copper (E <sub>Cu</sub> )
Contact plating	Tin
Fire load	0.693 MJ

Subject to changes. Please also observe the further product documentation!

Actuator color	orange
Weight	36.7 g

### Environmental requirements

Limit temperature range	-60 ... +105 °C
Processing temperature	-35 ... +60 °C

### Commercial data



ETIM 8.0	EC001284
ETIM 7.0	EC001284
ECCN	NO DATA
PU (SPU)	12 pcs
Packaging type	box
Country of origin	DE
GTIN	4066966070699
Customs tariff number	85366990990

### Environmental Product Compliance

RoHS Compliance Status	Compliant, No Exemption
------------------------	-------------------------





### Approvals / Certificates

#### General approvals

Logo	Approval	Additional Approval Text	Certificate name
	CB DEKRA Certification B.V.	IEC 61984	NL-61360 /M1
	CSA DEKRA Certification B.V.	C22.2	1466354
	KEMA/KEUR DEKRA Certification B.V.	EN 61984	71-116057
	UR Underwriters Laboratories Inc.	UL 1059	E45172







Subject to changes. Please also observe the further product documentation!

## Counterpart

	<b>Item no.831-1205</b> 1-conductor male connector; lever; Push-in CAGE CLAMP®; 10 mm <sup>2</sup> ; Pin spacing 7.62 mm; 5-pole; 100% protected against mismatching; 10,00 mm <sup>2</sup> ; light gray	<a href="http://www.wago.com/831-1205">www.wago.com/831-1205</a>
	<b>Item no.831-3605</b> THT male header; 1.0 x 1.2 mm solder pin; straight; 100% protected against mismatching; Pin spacing 7.62 mm; 5-pole; light gray	<a href="http://www.wago.com/831-3605">www.wago.com/831-3605</a>
	<b>Item no.831-3625</b> THT male header; 1.0 x 1.2 mm solder pin; angled; 100% protected against mismatching; Pin spacing 7.62 mm; 5-pole; light gray	<a href="http://www.wago.com/831-3625">www.wago.com/831-3625</a>
	<b>Item no.831-3645</b> THT male header; 1.0 x 1.2 mm solder pin; angled; 100% protected against mismatching; Pin spacing 7.62 mm; 5-pole; light gray	<a href="http://www.wago.com/831-3645">www.wago.com/831-3645</a>
	<b>Item no.831-1205/306-000</b> 1-conductor male connector; lever; Push-in CAGE CLAMP®; 10 mm <sup>2</sup> ; Pin spacing 7.62 mm; 5-pole; 100% protected against mismatching; DIN-35 rail/panel mounting; 10,00 mm <sup>2</sup> ; light gray	<a href="http://www.wago.com/831-1205/306-000">www.wago.com/831-1205/306-000</a>

## Optional accessories

### Ferrule

Ferrule		
	<b>Item no.: 216-101</b> Ferrule; Sleeve for 0.5 mm <sup>2</sup> / AWG 22; uninsulated; electro-tin plated; silver-colored	<a href="http://www.wago.com/216-101">www.wago.com/216-101</a>
	<b>Item no.: 216-104</b> Ferrule; Sleeve for 1.5 mm <sup>2</sup> / AWG 16; uninsulated; electro-tin plated; silver-colored	<a href="http://www.wago.com/216-104">www.wago.com/216-104</a>
	<b>Item no.: 216-106</b> Ferrule; Sleeve for 2.5 mm <sup>2</sup> / AWG 14; uninsulated; electro-tin plated; silver-colored	<a href="http://www.wago.com/216-106">www.wago.com/216-106</a>
	<b>Item no.: 216-107</b> Ferrule; Sleeve for 4 mm <sup>2</sup> / AWG 12; uninsulated; electro-tin plated	<a href="http://www.wago.com/216-107">www.wago.com/216-107</a>
	<b>Item no.: 216-108</b> Ferrule; Sleeve for 6 mm <sup>2</sup> / AWG 10; uninsulated; electro-tin plated; silver-colored	<a href="http://www.wago.com/216-108">www.wago.com/216-108</a>
	<b>Item no.: 216-102</b> Ferrule; Sleeve for 0.75 mm <sup>2</sup> / AWG 20; uninsulated; electro-tin plated; silver-colored	<a href="http://www.wago.com/216-102">www.wago.com/216-102</a>
	<b>Item no.: 216-103</b> Ferrule; Sleeve for 1 mm <sup>2</sup> / AWG 18; uninsulated; electro-tin plated	<a href="http://www.wago.com/216-103">www.wago.com/216-103</a>

Subject to changes. Please also observe the further product documentation!

	<b>Item no.: 216-123</b> Ferrule; Sleeve for 1 mm <sup>2</sup> / AWG 18; uninsulated; electro-tin plated; silver-colored	<a href="http://www.wago.com/216-123">www.wago.com/216-123</a>
	<b>Item no.: 216-122</b> Ferrule; Sleeve for 0.75 mm <sup>2</sup> / AWG 20; uninsulated; electro-tin plated; silver-colored	<a href="http://www.wago.com/216-122">www.wago.com/216-122</a>
	<b>Item no.: 216-124</b> Ferrule; Sleeve for 1.5 mm <sup>2</sup> / AWG 16; uninsulated; electro-tin plated	<a href="http://www.wago.com/216-124">www.wago.com/216-124</a>
	<b>Item no.: 216-142</b> Ferrule; Sleeve for 0.75 mm <sup>2</sup> / 18 AWG; uninsulated; electro-tin plated; electrolytic copper; gastight crimped; acc. to DIN 46228, Part 1/08.92	<a href="http://www.wago.com/216-142">www.wago.com/216-142</a>
	<b>Item no.: 216-132</b> Ferrule; Sleeve for 0.34 mm <sup>2</sup> / AWG 24; uninsulated; electro-tin plated	<a href="http://www.wago.com/216-132">www.wago.com/216-132</a>
	<b>Item no.: 216-121</b> Ferrule; Sleeve for 0.5 mm <sup>2</sup> / AWG 22; uninsulated; electro-tin plated; silver-colored	<a href="http://www.wago.com/216-121">www.wago.com/216-121</a>
	<b>Item no.: 216-143</b> Ferrule; Sleeve for 1 mm <sup>2</sup> / AWG 18; uninsulated; electro-tin plated; electrolytic copper; gastight crimped; acc. to DIN 46228, Part 1/08.92	<a href="http://www.wago.com/216-143">www.wago.com/216-143</a>
	<b>Item no.: 216-131</b> Ferrule; Sleeve for 0.25 mm <sup>2</sup> / AWG 24; uninsulated; electro-tin plated; silver-colored	<a href="http://www.wago.com/216-131">www.wago.com/216-131</a>
	<b>Item no.: 216-141</b> Ferrule; Sleeve for 0.5 mm <sup>2</sup> / 20 AWG; uninsulated; electro-tin plated; electrolytic copper; gastight crimped; acc. to DIN 46228, Part 1/08.92	<a href="http://www.wago.com/216-141">www.wago.com/216-141</a>
	<b>Item no.: 216-152</b> Ferrule; Sleeve for 0.34 mm <sup>2</sup> / AWG 24; uninsulated; electro-tin plated	<a href="http://www.wago.com/216-152">www.wago.com/216-152</a>
	<b>Item no.: 216-203</b> Ferrule; Sleeve for 1 mm <sup>2</sup> / AWG 18; insulated; electro-tin plated; red	<a href="http://www.wago.com/216-203">www.wago.com/216-203</a>
	<b>Item no.: 216-206</b> Ferrule; Sleeve for 2.5 mm <sup>2</sup> / AWG 14; insulated; electro-tin plated; blue	<a href="http://www.wago.com/216-206">www.wago.com/216-206</a>
	<b>Item no.: 216-207</b> Ferrule; Sleeve for 4 mm <sup>2</sup> / AWG 12; insulated; electro-tin plated; gray	<a href="http://www.wago.com/216-207">www.wago.com/216-207</a>
	<b>Item no.: 216-202</b> Ferrule; Sleeve for 0.75 mm <sup>2</sup> / 18 AWG; insulated; electro-tin plated; gray	<a href="http://www.wago.com/216-202">www.wago.com/216-202</a>
	<b>Item no.: 216-151</b> Ferrule; Sleeve for 0.25 mm <sup>2</sup> / AWG 24; uninsulated; electro-tin plated	<a href="http://www.wago.com/216-151">www.wago.com/216-151</a>
	<b>Item no.: 216-204</b> Ferrule; Sleeve for 1.5 mm <sup>2</sup> / AWG 16; insulated; electro-tin plated; black	<a href="http://www.wago.com/216-204">www.wago.com/216-204</a>
	<b>Item no.: 216-205</b> Ferrule; Sleeve for 2.08 mm <sup>2</sup> / AWG 14; insulated; electro-tin plated; yellow	<a href="http://www.wago.com/216-205">www.wago.com/216-205</a>
	<b>Item no.: 216-144</b> Ferrule; Sleeve for 1.5 mm <sup>2</sup> / AWG 16; uninsulated; electro-tin plated; electrolytic copper; gastight	<a href="http://www.wago.com/216-144">www.wago.com/216-144</a>

Subject to changes. Please also observe the further product documentation!

WAGO GmbH & Co. KG

Hansastr. 27

32423 Minden

Phone: +49571 887-0 | Fax: +49571 887-169

Email: [info.de@wago.com](mailto:info.de@wago.com) | Web: [www.wago.com](http://www.wago.com)

Do you have any questions about our products?

We are always happy to take your call at +49 (571) 887-44222.





crimped; acc. to DIN 46228, Part 1/08.92; silver-colored

	<b>Item no.: 216-208</b> Ferrule; Sleeve for 6 mm <sup>2</sup> / AWG 10; insulated; electro-tin plated; electrolytic copper; gastight crimped; acc. to DIN 46228, Part 4/09.90; yellow	<a href="http://www.wago.com/216-208">www.wago.com/216-208</a>
	<b>Item no.: 216-201</b> Ferrule; Sleeve for 0.5 mm <sup>2</sup> / 20 AWG; insulated; electro-tin plated; white	<a href="http://www.wago.com/216-201">www.wago.com/216-201</a>
	<b>Item no.: 216-223</b> Ferrule; Sleeve for 1 mm <sup>2</sup> / AWG 18; insulated; electro-tin plated; red	<a href="http://www.wago.com/216-223">www.wago.com/216-223</a>
	<b>Item no.: 216-241</b> Ferrule; Sleeve for 0.5 mm <sup>2</sup> / 20 AWG; insulated; electro-tin plated; electrolytic copper; gastight crimped; acc. to DIN 46228, Part 4/09.90; white	<a href="http://www.wago.com/216-241">www.wago.com/216-241</a>
	<b>Item no.: 216-242</b> Ferrule; Sleeve for 0.75 mm <sup>2</sup> / 18 AWG; insulated; electro-tin plated; electrolytic copper; gastight crimped; acc. to DIN 46228, Part 4/09.90; gray	<a href="http://www.wago.com/216-242">www.wago.com/216-242</a>
	<b>Item no.: 216-222</b> Ferrule; Sleeve for 0.75 mm <sup>2</sup> / 18 AWG; insulated; electro-tin plated; gray	<a href="http://www.wago.com/216-222">www.wago.com/216-222</a>
	<b>Item no.: 216-221</b> Ferrule; Sleeve for 0.5 mm <sup>2</sup> / 20 AWG; insulated; electro-tin plated; white	<a href="http://www.wago.com/216-221">www.wago.com/216-221</a>
	<b>Item no.: 216-224</b> Ferrule; Sleeve for 1.5 mm <sup>2</sup> / AWG 16; insulated; electro-tin plated; black	<a href="http://www.wago.com/216-224">www.wago.com/216-224</a>
	<b>Item no.: 216-243</b> Ferrule; Sleeve for 1 mm <sup>2</sup> / AWG 18; insulated; electro-tin plated; electrolytic copper; gastight crimped; acc. to DIN 46228, Part 4/09.90; red	<a href="http://www.wago.com/216-243">www.wago.com/216-243</a>
	<b>Item no.: 216-244</b> Ferrule; Sleeve for 1.5 mm <sup>2</sup> / AWG 16; insulated; electro-tin plated; electrolytic copper; gastight crimped; acc. to DIN 46228, Part 4/09.90; black	<a href="http://www.wago.com/216-244">www.wago.com/216-244</a>
	<b>Item no.: 216-263</b> Ferrule; Sleeve for 1 mm <sup>2</sup> / AWG 18; insulated; electro-tin plated; electrolytic copper; gastight crimped; acc. to DIN 46228, Part 4/09.90; red	<a href="http://www.wago.com/216-263">www.wago.com/216-263</a>
	<b>Item no.: 216-246</b> Ferrule; Sleeve for 2.5 mm <sup>2</sup> / AWG 14; insulated; electro-tin plated; electrolytic copper; gastight crimped; acc. to DIN 46228, Part 4/09.90; blue	<a href="http://www.wago.com/216-246">www.wago.com/216-246</a>
	<b>Item no.: 216-266</b> Ferrule; Sleeve for 2.5 mm <sup>2</sup> / AWG 14; insulated; electro-tin plated; electrolytic copper; gastight crimped; acc. to DIN 46228, Part 4/09.90; blue	<a href="http://www.wago.com/216-266">www.wago.com/216-266</a>
	<b>Item no.: 216-264</b> Ferrule; Sleeve for 1.5 mm <sup>2</sup> / AWG 16; insulated; electro-tin plated; electrolytic copper; gastight crimped; acc. to DIN 46228, Part 4/09.90; black	<a href="http://www.wago.com/216-264">www.wago.com/216-264</a>
	<b>Item no.: 216-286</b> Ferrule; Sleeve for 2.5 mm <sup>2</sup> / AWG 14; insulated; electro-tin plated; electrolytic copper; gastight crimped; acc. to DIN 46228, Part 4/09.90; blue	<a href="http://www.wago.com/216-286">www.wago.com/216-286</a>
	<b>Item no.: 216-287</b> Ferrule; Sleeve for 4 mm <sup>2</sup> / AWG 12; insulated; electro-tin plated; electrolytic copper; gastight crimped; acc. to DIN 46228, Part 4/09.90; gray	<a href="http://www.wago.com/216-287">www.wago.com/216-287</a>

Subject to changes. Please also observe the further product documentation!



	<p><b>Item no.: 216-262</b>                  Ferrule; Sleeve for 0.75 mm<sup>2</sup> / 18 AWG; insulated; electro-tin plated; electrolytic copper; gastight crimped; acc. to DIN 46228, Part 4/09.90; gray</p>	<a href="http://www.wago.com/216-262">www.wago.com/216-262</a>
	<p><b>Item no.: 216-288</b>                  Ferrule; Sleeve for 6 mm<sup>2</sup> / AWG 10; insulated; electro-tin plated; electrolytic copper; gastight crimped; acc. to DIN 46228, Part 4/09.90; yellow</p>	<a href="http://www.wago.com/216-288">www.wago.com/216-288</a>
	<p><b>Item no.: 216-267</b>                  Ferrule; Sleeve for 4 mm<sup>2</sup> / AWG 12; insulated; electro-tin plated; electrolytic copper; gastight crimped; acc. to DIN 46228, Part 4/09.90; gray</p>	<a href="http://www.wago.com/216-267">www.wago.com/216-267</a>

## Downloads

### Documentation

#### Additional Information

Technical Section	2019 Apr 3	pdf	Download
Technical explanations		2.1 MB	

## CAD/CAE-Data

### CAD data

2D/3D Models 831-1105/037-000	URL	Download
-------------------------------	-----	----------

### Asset Administration Shell

Asset Administration Shell 831-1105/037-000	URL	Download
---	-----	----------

## Environmental Product Compliance

### Compliance Search

Environmental Product Compliance 831-1105/037-000 1-conductor female connector; lever; Push-in CAGE CLAMP®; 10 mm <sup>2</sup> ; Pin spacing 7.62 mm; 5-pole; 100% protected against mismatching; Lateral locking levers; 10,00 mm <sup>2</sup> ; light gray	URL	Download
---	-----	----------

## Installation Notes

### Conductor termination

Subject to changes. Please also observe the further product documentation!

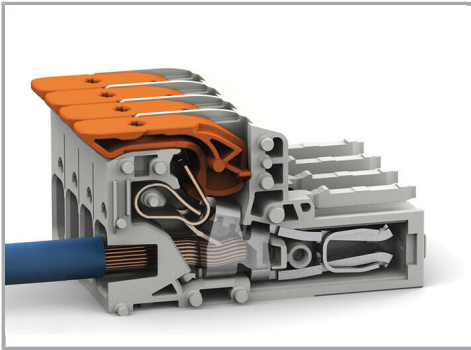

Insert solid conductors via push-in termination.

#### Conductor removal

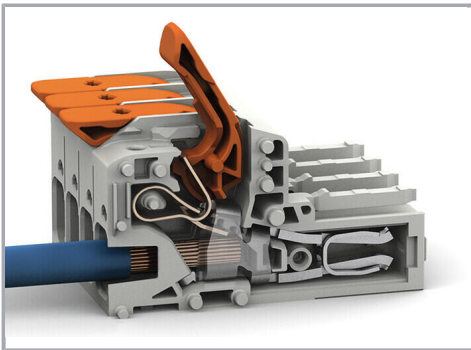

Insert fine-stranded conductors – and remove all conductors – via operating tool.

#### Product family

**MCS MAXI 6**

[Show all products from the family](#)

Subject to changes. Please also observe the further product documentation!