

## Data sheet | Item number: 769-602

1-conductor male connector; CAGE CLAMP®; 4 mm<sup>2</sup>; Pin spacing 5 mm; 2-pole; 4,00 mm<sup>2</sup>; gray

[www.wago.com/769-602](http://www.wago.com/769-602)

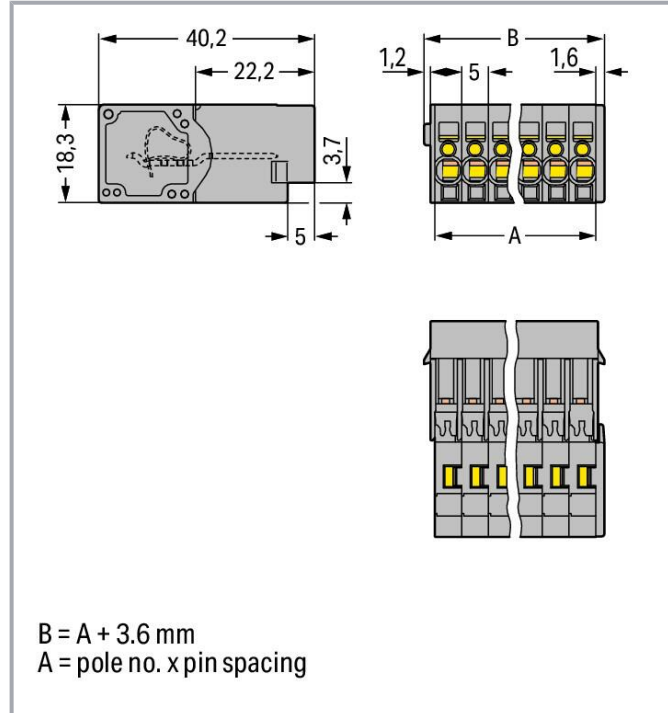
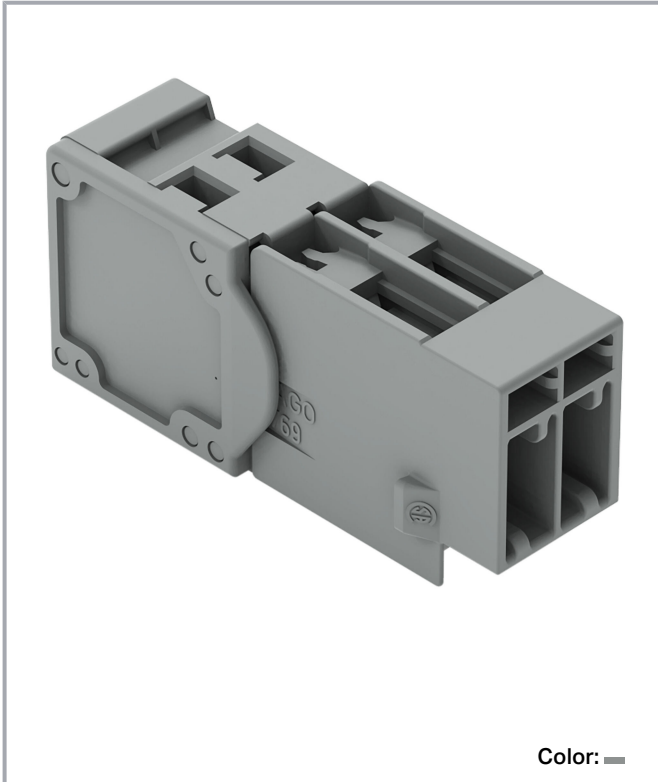

### Data

#### Electrical data

#### Ratings per IEC/EN

Nominal voltage (III/3)	500 V
Rated impulse voltage (III/3)	6 kV
Rated current	32 A
Legend (ratings)	(III / 3) ≙ Overvoltage category III / Pollution degree 3

#### Connection data

Connection points	2
Total number of potentials	2

Subject to changes. Please also observe the further product documentation!

WAGO GmbH & Co. KG  
Hansastr. 27  
32423 Minden  
Phone: +49571 887-0 | Fax: +49571 887-169  
Email: [info.de@wago.com](mailto:info.de@wago.com) | Web: [www.wago.com](http://www.wago.com)

Do you have any questions about our products?  
We are always happy to take your call at +49 (571) 887-44222.



## Connection 1

Connection technology	CAGE CLAMP®
Actuation type	Operating tool
Connectable conductor materials	Copper
Nominal cross-section	4 mm <sup>2</sup> / 12 AWG
Solid conductor	0.08 ... 4 mm <sup>2</sup> / 28 ... 12 AWG
Fine-stranded conductor	0.08 ... 4 mm <sup>2</sup> / 28 ... 12 AWG
Strip length	8 ... 9 mm / 0.31 ... 0.35 inches
Pole number	2
Wiring direction	Front-entry wiring

## Physical data

Pin spacing	5 mm / 0.197 inches
Width	13.6 mm / 0.535 inches
Height	18.3 mm / 0.72 inches
Depth	40.2 mm / 1.583 inches

## Mechanical Data

Variable coding	Yes
Direct ground contact to DIN-rail/drilled hole/housing	No
Mounting type	Flying leads
Anti-rotation protection	Yes

## Plug-in connection

Contact type (pluggable connector)	Male connector/plug
Connector (connection type)	for conductor
Mismating protection	No
Plugging without loss of pin spacing	No

## Material data

Note (material data)	Information on material specifications can be found here
Color	gray
Material group	I
Insulation material	Polyamide (PA66)

Subject to changes. Please also observe the further product documentation!

Flammability class per UL94	V0
Fire load	0.179 MJ
Weight	6.6 g

### Environmental requirements

Processing temperature	-35 ... +85 °C
Continuous operating temperature	-60 ... +105 °C

### Commercial data



Product Group	18 (X-COM-System)
eCl@ss 10.0	27-14-11-06
eCl@ss 9.0	27-14-11-06
ETIM 8.0	EC001284
ETIM 7.0	EC001284
ECCN	NO DATA
PU (SPU)	100 pcs
Packaging type	Box
Country of origin	PL
GTIN	4044918520676
Customs tariff number	85366930000

### Environmental Product Compliance





RoHS Compliance Status	Compliant, No Exemption
------------------------	-------------------------

### Approvals / Certificates



#### General approvals

Logo	Approval	Additional Approval Text	Certificate name
	CCA DEKRA Certification B.V.	EN 60947	NTR NL-7626
	CCA DEKRA Certification B.V.	IEC 61984	NL-47799/A1
	CCA DEKRA Certification B.V.	EN 61984	2190419.02

Subject to changes. Please also observe the further product documentation!

	CSA CSA Group	C22.2	1101144
	KEMA/KEUR DEKRA Certification B.V.	EN 60947	2190419.01
	UL Underwriters Laboratories Inc.	UL 1977	E 45171
	UR Underwriters Laboratories Inc.	UL 1059	E45172

Declarations of conformity and manufacturer's declarations

Logo	Approval	Additional Approval Text	Certificate name
	EU-Declaration of Conformity WAGO GmbH & Co. KG	-	-
	UK-Declaration of Conformity WAGO GmbH & Co. KG	-	-

Approvals for marine applications

Logo	Approval	Additional Approval Text	Certificate name
	DNV GL Det Norske Veritas, Germanischer Lloyd	-	TAE00001V2

Counterpart





Item no.769-102

1-conductor female connector; CAGE CLAMP®; 4 mm<sup>2</sup>; Pin spacing 5 mm; 2-pole; coding finger; 4,00 mm<sup>2</sup>; gray

[www.wago.com/769-102](http://www.wago.com/769-102)

Item no.769-102/021-000

Subject to changes. Please also observe the further product documentation!

	1-conductor female connector; CAGE CLAMP®; 4 mm²; Pin spacing 5 mm; 2-pole; coding finger; Lateral locking levers; 4,00 mm²; gray	<a href="http://www.wago.com/769-102/021-000">www.wago.com/769-102/021-000</a>
	<b>Item no. 769-122</b> 2-conductor female connector; CAGE CLAMP®; 4 mm²; Pin spacing 5 mm; 2-pole; coding finger; 4,00 mm²; gray	<a href="http://www.wago.com/769-122">www.wago.com/769-122</a>

## Optional accessories

### Protective warning marker

Cover

	<b>Item no.: 280-415</b> Protective warning marker; for 5 terminal blocks; with high-voltage symbol, black; yellow	<a href="http://www.wago.com/280-415">www.wago.com/280-415</a>
--	---	--

### Coding

Coding

	<b>Item no.: 769-435</b> Coding pin; for coding of female plugs; for carrier terminal blocks / male connectors; orange	<a href="http://www.wago.com/769-435">www.wago.com/769-435</a>
--	---	--

### Marking accessories

Marking strip

	<b>Item no.: 210-831</b> Marking strips; on reel; 2.3 mm wide; plain; Self-adhesive; white	<a href="http://www.wago.com/210-831">www.wago.com/210-831</a>
--	---	--

	<b>Item no.: 210-833</b> Marking strips; 25 m on roll; 6 mm wide; plain; Self-adhesive; white	<a href="http://www.wago.com/210-833">www.wago.com/210-833</a>
---	--	--

	<b>Item no.: 210-834</b> Marking strips; on reel; 5 mm wide; plain; Self-adhesive; white	<a href="http://www.wago.com/210-834">www.wago.com/210-834</a>
--	---	--

	<b>Item no.: 210-832</b> Marking strips; on reel; 3 mm wide; plain; Self-adhesive; white	<a href="http://www.wago.com/210-832">www.wago.com/210-832</a>
--	---	--

Marker

	<b>Item no.: 248-501</b> Mini-WSB marking card; as card; not stretchable; plain; snap-on type; white	<a href="http://www.wago.com/248-501">www.wago.com/248-501</a>
--	---	--

### Tool

Operating tool

	<b>Item no.: 210-490</b> Operating tool	<a href="http://www.wago.com/210-490">www.wago.com/210-490</a>
--	--	--

	<b>Item no.: 769-434</b> Operating tool; made of insulating material; 1-way; loose; white	<a href="http://www.wago.com/769-434">www.wago.com/769-434</a>
--	--	--

### Ferrule



Ferrule

Subject to changes. Please also observe the further product documentation!

	<b>Item no.: 216-101</b> Ferrule; Sleeve for 0.5 mm <sup>2</sup> / AWG 22; uninsulated; electro-tin plated; silver-colored	<a href="http://www.wago.com/216-101">www.wago.com/216-101</a>
	<b>Item no.: 216-104</b> Ferrule; Sleeve for 1.5 mm <sup>2</sup> / AWG 16; uninsulated; electro-tin plated; silver-colored	<a href="http://www.wago.com/216-104">www.wago.com/216-104</a>
	<b>Item no.: 216-102</b> Ferrule; Sleeve for 0.75 mm <sup>2</sup> / AWG 20; uninsulated; electro-tin plated; silver-colored	<a href="http://www.wago.com/216-102">www.wago.com/216-102</a>
	<b>Item no.: 216-103</b> Ferrule; Sleeve for 1 mm <sup>2</sup> / AWG 18; uninsulated; electro-tin plated	<a href="http://www.wago.com/216-103">www.wago.com/216-103</a>
	<b>Item no.: 216-203</b> Ferrule; Sleeve for 1 mm <sup>2</sup> / AWG 18; insulated; electro-tin plated; red	<a href="http://www.wago.com/216-203">www.wago.com/216-203</a>
	<b>Item no.: 216-206</b> Ferrule; Sleeve for 2.5 mm <sup>2</sup> / AWG 14; insulated; electro-tin plated; blue	<a href="http://www.wago.com/216-206">www.wago.com/216-206</a>
	<b>Item no.: 216-202</b> Ferrule; Sleeve for 0.75 mm <sup>2</sup> / 18 AWG; insulated; electro-tin plated; gray	<a href="http://www.wago.com/216-202">www.wago.com/216-202</a>
	<b>Item no.: 216-204</b> Ferrule; Sleeve for 1.5 mm <sup>2</sup> / AWG 16; insulated; electro-tin plated; black	<a href="http://www.wago.com/216-204">www.wago.com/216-204</a>
	<b>Item no.: 216-201</b> Ferrule; Sleeve for 0.5 mm <sup>2</sup> / 20 AWG; insulated; electro-tin plated; white	<a href="http://www.wago.com/216-201">www.wago.com/216-201</a>



#### Strain relief

##### Strain relief

	<b>Item no.: 769-1602</b> Strain relief housing; for female and male connectors; 2 parts; Pin spacing 5 mm; 2-pole; gray	<a href="http://www.wago.com/769-1602">www.wago.com/769-1602</a>
	<b>Item no.: 769-411</b> Strain relief plate; for female and male connectors; 1 part; Pin spacing 5 mm; 2- to 3-pole; gray	<a href="http://www.wago.com/769-411">www.wago.com/769-411</a>

#### Insulation stop

##### Insulation stop

	<b>Item no.: 769-470</b> Insulation stop; 0.08 - 0.2 mm <sup>2</sup> "s" (0.14 mm <sup>2</sup> "f-st"); 5 pieces/strip; white	<a href="http://www.wago.com/769-470">www.wago.com/769-470</a>
	<b>Item no.: 769-471</b> Insulation stop; 0.25 - 0.5 mm <sup>2</sup> ; 5 pieces/strip; light gray	<a href="http://www.wago.com/769-471">www.wago.com/769-471</a>
	<b>Item no.: 769-472</b> Insulation stop; 0.75 - 1 mm <sup>2</sup> ; 5 pieces/strip; dark gray	<a href="http://www.wago.com/769-472">www.wago.com/769-472</a>

## Downloads

### Documentation

Subject to changes. Please also observe the further product documentation!



**Bid Text**

769-602 X81 - Datei	2019 Feb 19	xml 3.2 kB	Download
------------------------	-------------	---------------	----------

769-602 doc - Datei	2017 Oct 4	doc 25.1 kB	Download
------------------------	------------	----------------	----------

**Additional Information**

		pdf 2.3 MB	Download
--	--	---------------	----------

**CAD/CAE-Data**

**CAD data**

2D/3D Models 769-602		URL	Download
----------------------	--	-----	----------

**CAE data**

EPLAN Data Portal 769-602		URL	Download
---------------------------	--	-----	----------

WSCAD Universe 769-602		URL	Download
------------------------	--	-----	----------

ZUKEN Portal 769-602		URL	Download
----------------------	--	-----	----------

**Asset Administration Shell**

Asset Administration Shell 769-602		URL	Download
------------------------------------	--	-----	----------

**Environmental Product Compliance**

**Compliance Search**

Environmental Product Compliance 769-602 1-conductor male connector; CAGE CLAMP®; 4 mm²; Pin spacing 5 mm; 2-pole; 4,00 mm²; gray		URL	Download
--	--	-----	----------

**Installation Notes**

**Conductor termination**

Subject to changes. Please also observe the further product documentation!



Operating tool  
Inserting a conductor via operating tool  
(example shows a male connector).

### Application

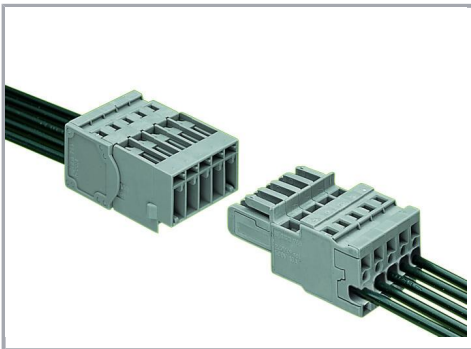

Male connector with CAGE CLAMP®  
connection  
1-connector female plug, straight

### Marking

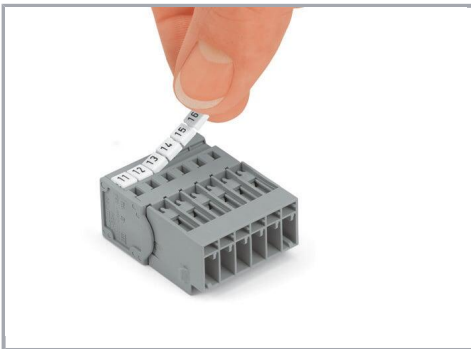

Labeling a male connector with CAGE CLAMP®  
connection via Mini-WSB Quick Markers.

### Product family

Subject to changes. Please also observe the further product documentation!





**X-COM**

[Show all products from the family](#)

Subject to changes. Please also observe the further product documentation!