

**Data sheet | Item number: 831-1102/037-000**

1-conductor female connector; lever; Push-in CAGE CLAMP®; 10 mm<sup>2</sup>; Pin spacing 7.62 mm; 2-pole; 100% protected against mismatching; Lateral locking levers; 10,00 mm<sup>2</sup>; light gray

[www.wago.com/831-1102/037-000](http://www.wago.com/831-1102/037-000)

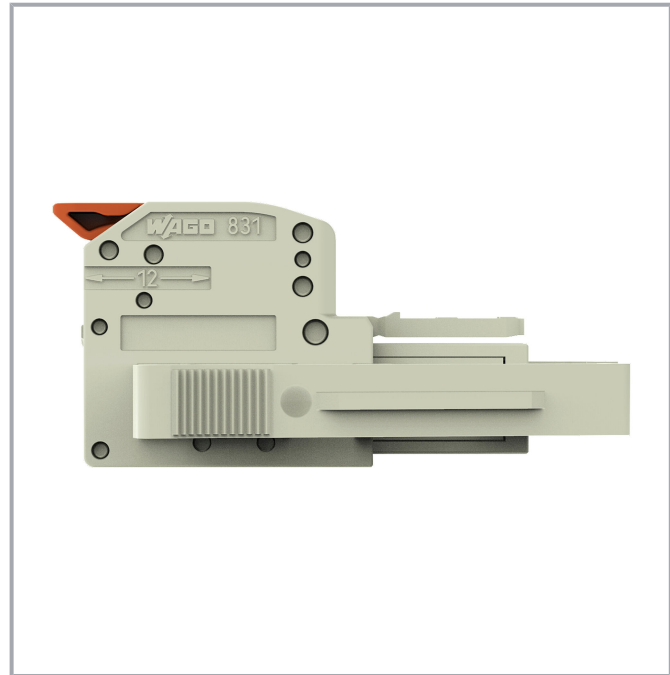
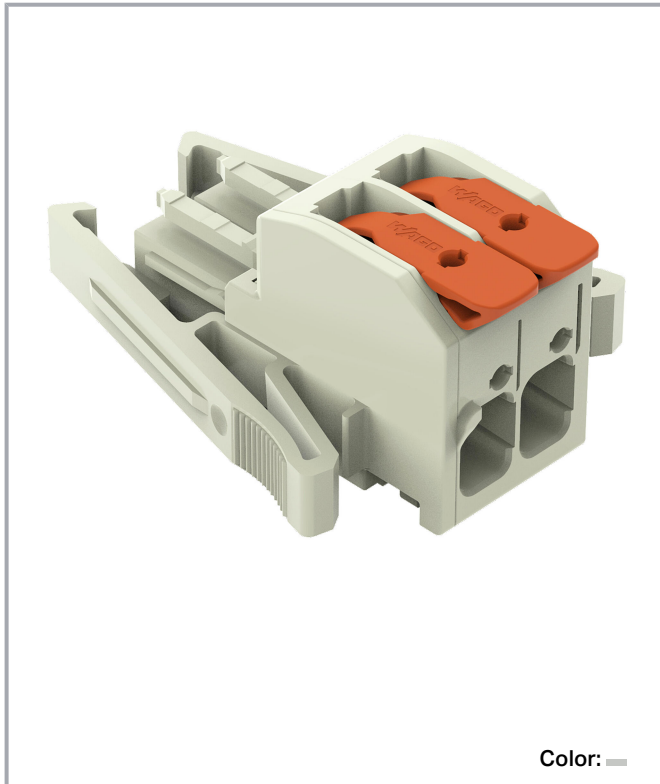

Subject to changes. Please also observe the further product documentation!

WAGO GmbH & Co. KG  
Hansastr. 27  
32423 Minden  
Phone: +49571 887-0 | Fax: +49571 887-169  
Email: [info.de@wago.com](mailto:info.de@wago.com) | Web: [www.wago.com](http://www.wago.com)

Do you have any questions about our products?  
We are always happy to take your call at +49 (571) 887-44222.



**Derating Curve**

1-conductor female connector (831-11xx) with  
1-conductor male connector (831-12xx)

Pin spacing: 7.62 mm / Conductor cross-section: 10 mm<sup>2</sup> "f-st"  
Based on: EN 60512-5-2 / Reduction factor: 0.8

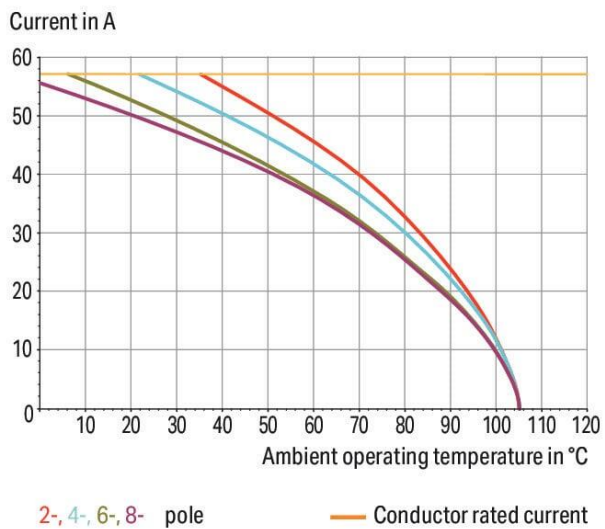

**Derating Curve**

1-conductor female connector (831-11xx) with  
THT male header (831-36xx)

Pin spacing: 7.62 mm / Conductor cross-section: 6 mm<sup>2</sup> "f-st"  
Based on: EN 60512-5-2 / Reduction factor: 0.8

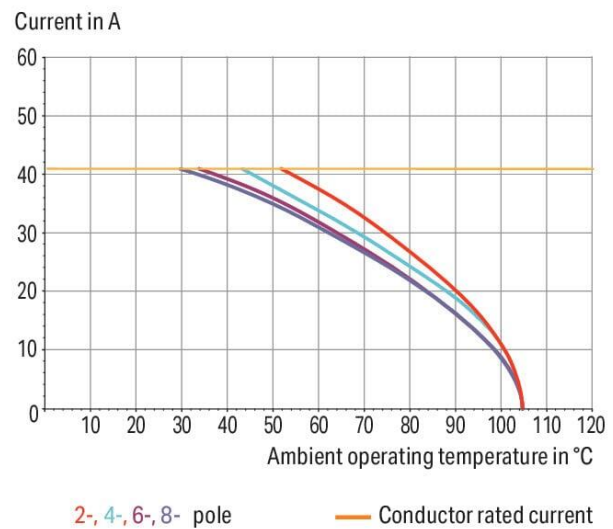

Subject to changes. Please also observe the further product documentation!

WAGO GmbH & Co. KG  
Hansastr. 27  
32423 Minden  
Phone: +49571 887-0 | Fax: +49571 887-169  
Email: [info.de@wago.com](mailto:info.de@wago.com) | Web: [www.wago.com](http://www.wago.com)

Do you have any questions about our products?  
We are always happy to take your call at +49 (571) 887-44222.

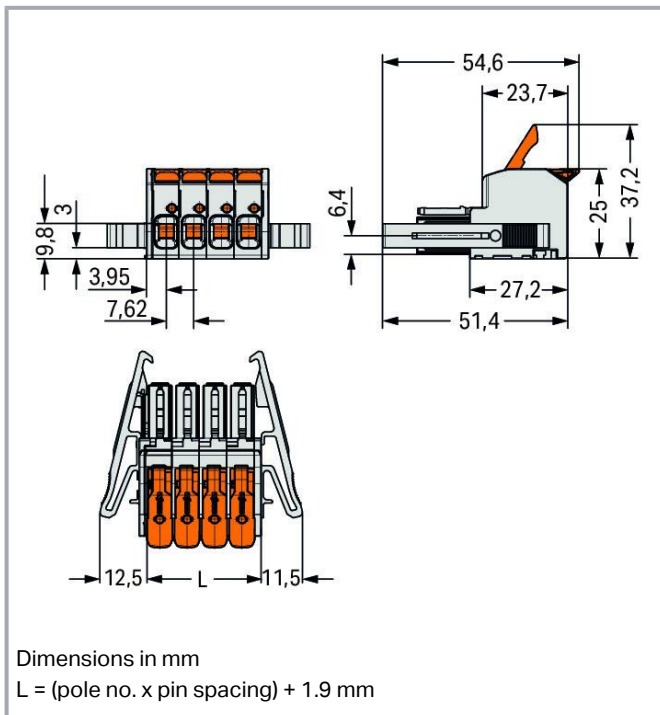

## Item description

- Intuitive and tool-free lever actuation
- Universal connection for all conductor types
- Push-in termination of solid and ferruled conductors
- Test slot 0° and 90° to conductor entry
- 100% protected against mismatching
- Coding option available

## Data

### Notes

#### Safety information

The *MCS – MULTI CONNECTION SYSTEM* includes connectors without breaking capacity in accordance with DIN EN 61984. When used as intended, these connectors must not be connected /disconnected when live or under load. When used as intended, these connectors must not be connected/disconnected when live or under load. The circuit design should ensure header pins, which can be touched, are not live when unmated.

#### Variants:

Other colors

Other versions (or variants) can be requested from WAGO Sales or configured at <https://configurator.wago.com/>.

Subject to changes. Please also observe the further product documentation!

WAGO GmbH & Co. KG

Hansastr. 27

32423 Minden

Phone: +49571 887-0 | Fax: +49571 887-169

Email: [info.de@wago.com](mailto:info.de@wago.com) | Web: [www.wago.com](http://www.wago.com)

Do you have any questions about our products?

We are always happy to take your call at +49 (571) 887-44222.

## Electrical data

### Ratings per IEC/EN

| Ratings per                   | IEC/EN 60664-1  |
|-------------------------------|---|
| Nominal voltage (III/3)       | 800 V   |
| Rated impulse voltage (III/3) | 8 kV  |
| Rated voltage (III/2)         | 1000 V  |
| Rated impulse voltage (III/2) | 8 kV  |
| Nominal voltage (II/2)        | 1000 V  |
| Rated surge voltage (II/2)    | 8 kV  |
| Rated current                 | 41 A  |
| Legend (ratings)              | (III / 2) $\hat{=}$ Overvoltage category III / Pollution degree 2 |

### Ratings per UL

| Approvals per                  | UL 1059 |
|--------------------------------|---------|
| Rated voltage UL (Use Group C) | 600 V   |
| Rated current UL (Use Group C) | 37 A    |
| Rated voltage UL (Use Group D) | 600 V   |
| Rated current UL (Use Group D) | 5 A     |

### Ratings per CSA

| Approvals per                   | CSA   |
|---------------------------------|-------|
| Rated voltage CSA (Use Group C) | 600 V |
| Rated current CSA (Use Group C) | 35 A  |
| Rated voltage CSA (Use Group D) | 600 V |
| Rated current CSA (Use Group D) | 5 A   |

## Connection data

|                            |   |
|----------------------------|---|
| Total number of potentials | 2 |
| Number of connection types | 1 |
| Number of levels           | 1 |

### Connection 1

|                       |                                 |
|-----------------------|---------------------------------|
| Connection technology | Push-in CAGE CLAMP <sup>®</sup> |
| Actuation type        | Lever                           |

Subject to changes. Please also observe the further product documentation!



|   |   |
|---|---|
| Solid conductor                                   | 0.5 ... 10 mm <sup>2</sup> / 20 ... 8 AWG |
| Fine-stranded conductor                           | 0.5 ... 10 mm <sup>2</sup> / 20 ... 8 AWG |
| Fine-stranded conductor; with insulated ferrule   | 0.5 ... 6 mm <sup>2</sup>                 |
| Fine-stranded conductor; with uninsulated ferrule | 0.5 ... 6 mm <sup>2</sup>                 |
| Strip length                                      | 11 ... 13 mm / 0.43 ... 0.51 inches       |
| Pole number                                       | 2   |
| Conductor entry direction to mating direction     | 0°  |

### Physical data

|             |                        |
|-------------|------------------------|
| Pin spacing | 7.62 mm / 0.3 inches   |
| Width       | 41.14 mm / 1.62 inches |
| Height      | 25 mm / 0.984 inches   |
| Depth       | 54.6 mm / 2.150 inches |

### Mechanical Data

|                          |     |
|--------------------------|-----|
| Variable coding          | Yes |
| Anti-rotation protection | Yes |

### Plug-in connection

|                                      |                         |
|--------------------------------------|-------------------------|
| Contact type (pluggable connector)   | Female connector/socket |
| Connector (connection type)          | for conductor           |
| Mismating protection                 | Yes                     |
| Plugging without loss of pin spacing | No                      |
| Locking of plug-in connection        | Locking lever           |

### Material data

|                             |  |
|-----------------------------|--|
| Note (material data)        | Information on material specifications can be found here |
| Color                       | light gray   |
| Material group              | I  |
| Insulation material         | Polyamide (PA66)   |
| Flammability class per UL94 | V0   |
| Clamping spring material    | Chrome-nickel spring steel (CrNi)                        |
| Contact material            | Electrolytic copper (E <sub>Cu</sub> )                   |
| Contact plating             | Tin  |
| Fire load                   | 0.321 MJ   |

Subject to changes. Please also observe the further product documentation!

|                |        |
|----------------|--------|
| Actuator color | orange |
| Weight         | 17.9 g |

### Environmental requirements

|                         |                 |
|-------------------------|-----------------|
| Limit temperature range | -60 ... +105 °C |
| Processing temperature  | -35 ... +60 °C  |

### Commercial data



|                       |               |
|-----------------------|---------------|
| ETIM 8.0              | EC001284      |
| ETIM 7.0              | EC001284      |
| ECCN                  | NO DATA       |
| PU (SPU)              | 24 pcs        |
| Packaging type        | box           |
| Country of origin     | DE            |
| GTIN                  | 4066966070637 |
| Customs tariff number | 85366990990   |

### Environmental Product Compliance

|                        |                         |
|------------------------|-------------------------|
| RoHS Compliance Status | Compliant, No Exemption |
|------------------------|-------------------------|





### Approvals / Certificates

#### General approvals

| Logo   | Approval                              | Additional Approval Text | Certificate name |
|--|---------------------------------------|--------------------------|------------------|
|  | CB<br>DEKRA Certification B.V.        | IEC 61984                | NL-61360<br>/M1  |
|  | CSA<br>DEKRA Certification B.V.       | C22.2                    | 1466354          |
|  | KEMA/KEUR<br>DEKRA Certification B.V. | EN 61984                 | 71-<br>116057    |
|  | UR<br>Underwriters Laboratories Inc.  | UL 1059                  | E45172           |







Subject to changes. Please also observe the further product documentation!

## Counterpart

|   |   |  |
|---|---|--|
|   | <b>Item no.831-1202</b><br>1-conductor male connector; lever; Push-in CAGE CLAMP®; 10 mm <sup>2</sup> ; Pin spacing 7.62 mm; 2-pole; 100% protected against mismatching; 10,00 mm <sup>2</sup> ; light gray                                     | <a href="http://www.wago.com/831-1202">www.wago.com/831-1202</a>                 |
|  | <b>Item no.831-3602</b><br>THT male header; 1.0 x 1.2 mm solder pin; straight; 100% protected against mismatching; Pin spacing 7.62 mm; 2-pole; light gray  | <a href="http://www.wago.com/831-3602">www.wago.com/831-3602</a>                 |
|   | <b>Item no.831-3622</b><br>THT male header; 1.0 x 1.2 mm solder pin; angled; 100% protected against mismatching; Pin spacing 7.62 mm; 2-pole; light gray  | <a href="http://www.wago.com/831-3622">www.wago.com/831-3622</a>                 |
|   | <b>Item no.831-3642</b><br>THT male header; 1.0 x 1.2 mm solder pin; angled; 100% protected against mismatching; Pin spacing 7.62 mm; 2-pole; light gray  | <a href="http://www.wago.com/831-3642">www.wago.com/831-3642</a>                 |
|  | <b>Item no.831-1202/306-000</b><br>1-conductor male connector; lever; Push-in CAGE CLAMP®; 10 mm <sup>2</sup> ; Pin spacing 7.62 mm; 2-pole; 100% protected against mismatching; DIN-35 rail/panel mounting; 10,00 mm <sup>2</sup> ; light gray | <a href="http://www.wago.com/831-1202/306-000">www.wago.com/831-1202/306-000</a> |

## Optional accessories

### Ferrule

| Ferrule   |  |  |
|---|--|--|
|  | <b>Item no.: 216-101</b><br>Ferrule; Sleeve for 0.5 mm <sup>2</sup> / AWG 22; uninsulated; electro-tin plated; silver-colored  | <a href="http://www.wago.com/216-101">www.wago.com/216-101</a> |
|  | <b>Item no.: 216-104</b><br>Ferrule; Sleeve for 1.5 mm <sup>2</sup> / AWG 16; uninsulated; electro-tin plated; silver-colored  | <a href="http://www.wago.com/216-104">www.wago.com/216-104</a> |
|  | <b>Item no.: 216-106</b><br>Ferrule; Sleeve for 2.5 mm <sup>2</sup> / AWG 14; uninsulated; electro-tin plated; silver-colored  | <a href="http://www.wago.com/216-106">www.wago.com/216-106</a> |
|  | <b>Item no.: 216-107</b><br>Ferrule; Sleeve for 4 mm <sup>2</sup> / AWG 12; uninsulated; electro-tin plated                    | <a href="http://www.wago.com/216-107">www.wago.com/216-107</a> |
|  | <b>Item no.: 216-108</b><br>Ferrule; Sleeve for 6 mm <sup>2</sup> / AWG 10; uninsulated; electro-tin plated; silver-colored    | <a href="http://www.wago.com/216-108">www.wago.com/216-108</a> |
|  | <b>Item no.: 216-102</b><br>Ferrule; Sleeve for 0.75 mm <sup>2</sup> / AWG 20; uninsulated; electro-tin plated; silver-colored | <a href="http://www.wago.com/216-102">www.wago.com/216-102</a> |
|  | <b>Item no.: 216-103</b><br>Ferrule; Sleeve for 1 mm <sup>2</sup> / AWG 18; uninsulated; electro-tin plated                    | <a href="http://www.wago.com/216-103">www.wago.com/216-103</a> |

Subject to changes. Please also observe the further product documentation!

|   |  |  |
|---|--|--|
|    | <b>Item no.: 216-123</b><br>Ferrule; Sleeve for 1 mm <sup>2</sup> / AWG 18; uninsulated; electro-tin plated; silver-colored  | <a href="http://www.wago.com/216-123">www.wago.com/216-123</a> |
|    | <b>Item no.: 216-122</b><br>Ferrule; Sleeve for 0.75 mm <sup>2</sup> / AWG 20; uninsulated; electro-tin plated; silver-colored   | <a href="http://www.wago.com/216-122">www.wago.com/216-122</a> |
|    | <b>Item no.: 216-124</b><br>Ferrule; Sleeve for 1.5 mm <sup>2</sup> / AWG 16; uninsulated; electro-tin plated  | <a href="http://www.wago.com/216-124">www.wago.com/216-124</a> |
|    | <b>Item no.: 216-142</b><br>Ferrule; Sleeve for 0.75 mm <sup>2</sup> / 18 AWG; uninsulated; electro-tin plated; electrolytic copper; gastight crimped; acc. to DIN 46228, Part 1/08.92 | <a href="http://www.wago.com/216-142">www.wago.com/216-142</a> |
|    | <b>Item no.: 216-132</b><br>Ferrule; Sleeve for 0.34 mm <sup>2</sup> / AWG 24; uninsulated; electro-tin plated   | <a href="http://www.wago.com/216-132">www.wago.com/216-132</a> |
|    | <b>Item no.: 216-121</b><br>Ferrule; Sleeve for 0.5 mm <sup>2</sup> / AWG 22; uninsulated; electro-tin plated; silver-colored  | <a href="http://www.wago.com/216-121">www.wago.com/216-121</a> |
|    | <b>Item no.: 216-143</b><br>Ferrule; Sleeve for 1 mm <sup>2</sup> / AWG 18; uninsulated; electro-tin plated; electrolytic copper; gastight crimped; acc. to DIN 46228, Part 1/08.92    | <a href="http://www.wago.com/216-143">www.wago.com/216-143</a> |
|    | <b>Item no.: 216-131</b><br>Ferrule; Sleeve for 0.25 mm <sup>2</sup> / AWG 24; uninsulated; electro-tin plated; silver-colored   | <a href="http://www.wago.com/216-131">www.wago.com/216-131</a> |
|    | <b>Item no.: 216-141</b><br>Ferrule; Sleeve for 0.5 mm <sup>2</sup> / 20 AWG; uninsulated; electro-tin plated; electrolytic copper; gastight crimped; acc. to DIN 46228, Part 1/08.92  | <a href="http://www.wago.com/216-141">www.wago.com/216-141</a> |
|  | <b>Item no.: 216-152</b><br>Ferrule; Sleeve for 0.34 mm <sup>2</sup> / AWG 24; uninsulated; electro-tin plated   | <a href="http://www.wago.com/216-152">www.wago.com/216-152</a> |
|  | <b>Item no.: 216-203</b><br>Ferrule; Sleeve for 1 mm <sup>2</sup> / AWG 18; insulated; electro-tin plated; red   | <a href="http://www.wago.com/216-203">www.wago.com/216-203</a> |
|  | <b>Item no.: 216-206</b><br>Ferrule; Sleeve for 2.5 mm <sup>2</sup> / AWG 14; insulated; electro-tin plated; blue  | <a href="http://www.wago.com/216-206">www.wago.com/216-206</a> |
|  | <b>Item no.: 216-207</b><br>Ferrule; Sleeve for 4 mm <sup>2</sup> / AWG 12; insulated; electro-tin plated; gray  | <a href="http://www.wago.com/216-207">www.wago.com/216-207</a> |
|  | <b>Item no.: 216-202</b><br>Ferrule; Sleeve for 0.75 mm <sup>2</sup> / 18 AWG; insulated; electro-tin plated; gray   | <a href="http://www.wago.com/216-202">www.wago.com/216-202</a> |
|  | <b>Item no.: 216-151</b><br>Ferrule; Sleeve for 0.25 mm <sup>2</sup> / AWG 24; uninsulated; electro-tin plated   | <a href="http://www.wago.com/216-151">www.wago.com/216-151</a> |
|  | <b>Item no.: 216-204</b><br>Ferrule; Sleeve for 1.5 mm <sup>2</sup> / AWG 16; insulated; electro-tin plated; black   | <a href="http://www.wago.com/216-204">www.wago.com/216-204</a> |
|  | <b>Item no.: 216-205</b><br>Ferrule; Sleeve for 2.08 mm <sup>2</sup> / AWG 14; insulated; electro-tin plated; yellow   | <a href="http://www.wago.com/216-205">www.wago.com/216-205</a> |
|  | <b>Item no.: 216-144</b><br>Ferrule; Sleeve for 1.5 mm <sup>2</sup> / AWG 16; uninsulated; electro-tin plated; electrolytic copper; gastight   | <a href="http://www.wago.com/216-144">www.wago.com/216-144</a> |

Subject to changes. Please also observe the further product documentation!





crimped; acc. to DIN 46228, Part 1/08.92; silver-colored

|   |  |  |
|---|--|--|
|    | <b>Item no.: 216-208</b><br>Ferrule; Sleeve for 6 mm <sup>2</sup> / AWG 10; insulated; electro-tin plated; electrolytic copper; gastight crimped; acc. to DIN 46228, Part 4/09.90; yellow  | <a href="http://www.wago.com/216-208">www.wago.com/216-208</a> |
|    | <b>Item no.: 216-201</b><br>Ferrule; Sleeve for 0.5 mm <sup>2</sup> / 20 AWG; insulated; electro-tin plated; white   | <a href="http://www.wago.com/216-201">www.wago.com/216-201</a> |
|    | <b>Item no.: 216-223</b><br>Ferrule; Sleeve for 1 mm <sup>2</sup> / AWG 18; insulated; electro-tin plated; red   | <a href="http://www.wago.com/216-223">www.wago.com/216-223</a> |
|    | <b>Item no.: 216-241</b><br>Ferrule; Sleeve for 0.5 mm <sup>2</sup> / 20 AWG; insulated; electro-tin plated; electrolytic copper; gastight crimped; acc. to DIN 46228, Part 4/09.90; white | <a href="http://www.wago.com/216-241">www.wago.com/216-241</a> |
|    | <b>Item no.: 216-242</b><br>Ferrule; Sleeve for 0.75 mm <sup>2</sup> / 18 AWG; insulated; electro-tin plated; electrolytic copper; gastight crimped; acc. to DIN 46228, Part 4/09.90; gray | <a href="http://www.wago.com/216-242">www.wago.com/216-242</a> |
|    | <b>Item no.: 216-222</b><br>Ferrule; Sleeve for 0.75 mm <sup>2</sup> / 18 AWG; insulated; electro-tin plated; gray   | <a href="http://www.wago.com/216-222">www.wago.com/216-222</a> |
|    | <b>Item no.: 216-221</b><br>Ferrule; Sleeve for 0.5 mm <sup>2</sup> / 20 AWG; insulated; electro-tin plated; white   | <a href="http://www.wago.com/216-221">www.wago.com/216-221</a> |
|    | <b>Item no.: 216-224</b><br>Ferrule; Sleeve for 1.5 mm <sup>2</sup> / AWG 16; insulated; electro-tin plated; black   | <a href="http://www.wago.com/216-224">www.wago.com/216-224</a> |
|  | <b>Item no.: 216-243</b><br>Ferrule; Sleeve for 1 mm <sup>2</sup> / AWG 18; insulated; electro-tin plated; electrolytic copper; gastight crimped; acc. to DIN 46228, Part 4/09.90; red     | <a href="http://www.wago.com/216-243">www.wago.com/216-243</a> |
|  | <b>Item no.: 216-244</b><br>Ferrule; Sleeve for 1.5 mm <sup>2</sup> / AWG 16; insulated; electro-tin plated; electrolytic copper; gastight crimped; acc. to DIN 46228, Part 4/09.90; black | <a href="http://www.wago.com/216-244">www.wago.com/216-244</a> |
|  | <b>Item no.: 216-263</b><br>Ferrule; Sleeve for 1 mm <sup>2</sup> / AWG 18; insulated; electro-tin plated; electrolytic copper; gastight crimped; acc. to DIN 46228, Part 4/09.90; red     | <a href="http://www.wago.com/216-263">www.wago.com/216-263</a> |
|  | <b>Item no.: 216-246</b><br>Ferrule; Sleeve for 2.5 mm <sup>2</sup> / AWG 14; insulated; electro-tin plated; electrolytic copper; gastight crimped; acc. to DIN 46228, Part 4/09.90; blue  | <a href="http://www.wago.com/216-246">www.wago.com/216-246</a> |
|  | <b>Item no.: 216-266</b><br>Ferrule; Sleeve for 2.5 mm <sup>2</sup> / AWG 14; insulated; electro-tin plated; electrolytic copper; gastight crimped; acc. to DIN 46228, Part 4/09.90; blue  | <a href="http://www.wago.com/216-266">www.wago.com/216-266</a> |
|  | <b>Item no.: 216-264</b><br>Ferrule; Sleeve for 1.5 mm <sup>2</sup> / AWG 16; insulated; electro-tin plated; electrolytic copper; gastight crimped; acc. to DIN 46228, Part 4/09.90; black | <a href="http://www.wago.com/216-264">www.wago.com/216-264</a> |
|  | <b>Item no.: 216-286</b><br>Ferrule; Sleeve for 2.5 mm <sup>2</sup> / AWG 14; insulated; electro-tin plated; electrolytic copper; gastight crimped; acc. to DIN 46228, Part 4/09.90; blue  | <a href="http://www.wago.com/216-286">www.wago.com/216-286</a> |
|  | <b>Item no.: 216-287</b><br>Ferrule; Sleeve for 4 mm <sup>2</sup> / AWG 12; insulated; electro-tin plated; electrolytic copper; gastight crimped; acc. to DIN 46228, Part 4/09.90; gray    | <a href="http://www.wago.com/216-287">www.wago.com/216-287</a> |

Subject to changes. Please also observe the further product documentation!



|   |  |  |
|---|--|--|
|  | <b>Item no.: 216-262</b><br>Ferrule; Sleeve for 0.75 mm <sup>2</sup> / 18 AWG; insulated; electro-tin plated; electrolytic copper; gastight crimped; acc. to DIN 46228, Part 4/09.90; gray | <a href="http://www.wago.com/216-262">www.wago.com/216-262</a> |
|  | <b>Item no.: 216-288</b><br>Ferrule; Sleeve for 6 mm <sup>2</sup> / AWG 10; insulated; electro-tin plated; electrolytic copper; gastight crimped; acc. to DIN 46228, Part 4/09.90; yellow  | <a href="http://www.wago.com/216-288">www.wago.com/216-288</a> |
|  | <b>Item no.: 216-267</b><br>Ferrule; Sleeve for 4 mm <sup>2</sup> / AWG 12; insulated; electro-tin plated; electrolytic copper; gastight crimped; acc. to DIN 46228, Part 4/09.90; gray    | <a href="http://www.wago.com/216-267">www.wago.com/216-267</a> |

## Downloads

### Documentation

#### Additional Information

|                        |            |        |          |
|------------------------|------------|--------|----------|
| Technical Section      | 2019 Apr 3 | pdf    | Download |
| Technical explanations |            | 2.1 MB |          |

## CAD/CAE-Data

### CAD data

|                               |     |          |
|-------------------------------|-----|----------|
| 2D/3D Models 831-1102/037-000 | URL | Download |
|-------------------------------|-----|----------|

### Asset Administration Shell

|   |     |          |
|---|-----|----------|
| Asset Administration Shell 831-1102/037-000 | URL | Download |
|---|-----|----------|

## Environmental Product Compliance

### Compliance Search

|  |     |          |
|--|-----|----------|
| Environmental Product Compliance 831-1102/037-000  | URL | Download |
| 1-conductor female connector; lever; Push-in CAGE CLAMP®; 10 mm <sup>2</sup> ; Pin spacing 7.62 mm; 2-pole; 100% protected against mismatching; Lateral locking levers; 10,00 mm <sup>2</sup> ; light gray |     |          |

## Installation Notes

### Conductor termination

Subject to changes. Please also observe the further product documentation!

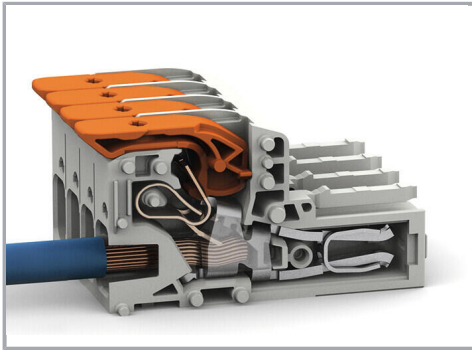

Insert solid conductors via push-in termination.

#### Conductor removal

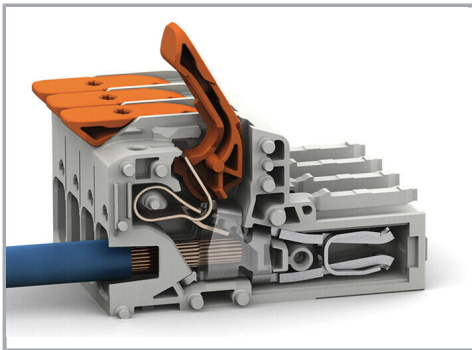

Insert fine-stranded conductors – and remove all conductors – via operating tool.

#### Product family

**MCS MAXI 6**

[Show all products from the family](#)

Subject to changes. Please also observe the further product documentation!