



Schottky Barrier Rectifiers
Reverse Voltage - 40 to 200 V
Forward Current - 30 A

FEATURES

- High current capability
- Low forward voltage drop
- Low power loss, high efficiency
- High surge capability
- High temperature soldering guaranteed
- Mounting position: any

Mechanical data

- Case: TO-220-3L
- Approx Weight: 2.04g (0.07oz)
- Lead free finish, RoHS compliant
- Case Material: “Green” molding compound, UL flammability classification 94V-0, “Halogen-free”.

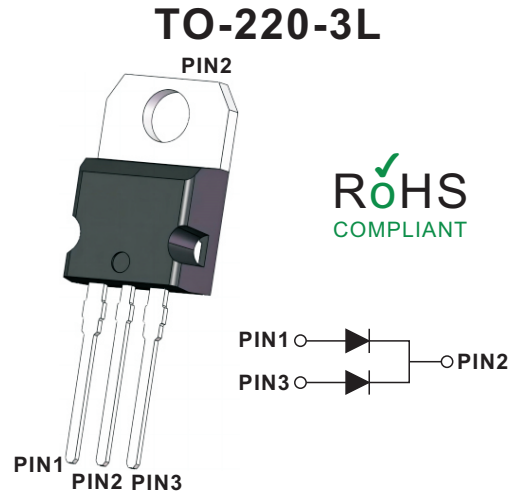

MAXIMUM RATINGS AND ELECTRICAL CHARACTERISTICS
Ratings at 25°C ambient temperature unless otherwise specified

CHARACTERISTICS	Symbols	MBR3040CT	MBR3045CT	MBR3060CT	MBR30100CT	MBR30150CT	MBR30200CT	Units
Maximum Recurrent Peak Reverse Voltage	V_{RRM}	40	45	60	100	150	200	V
Maximum RMS voltage	V_{RMS}	28	32	42	70	105	140	V
Maximum DC Blocking Voltage	V_{DC}	40	45	60	100	150	200	V
Maximum Average Forward Rectified Current per leg per device	$I_{F(AV)}$	15 30						A
Peak Forward Surge Current, 8.3ms Single Half Sine-wave Superimposed on Rated Load (JEDEC method) per leg	I_{FSM}	200						A
Max Instantaneous Forward Voltage at 15 A(per leg)	V_F	0.75		0.80	0.88	0.92	0.95	V
Maximum DC Reverse Current at Rated DC Reverse Voltage $T_a = 25^\circ\text{C}$ $T_a = 100^\circ\text{C}$	I_R	0.1 20			0.05 20			mA
Typical Thermal Resistance	$R_{\theta JC}$	4						°C/W
Operating Junction Temperature Range	T_j	-55 ~ +150				-55 ~ +175		°C
Storage Temperature Range	T_{stg}	-55 ~ +150				-55 ~ +175		°C



Fig.1 Typical Forward Current Derating Curve

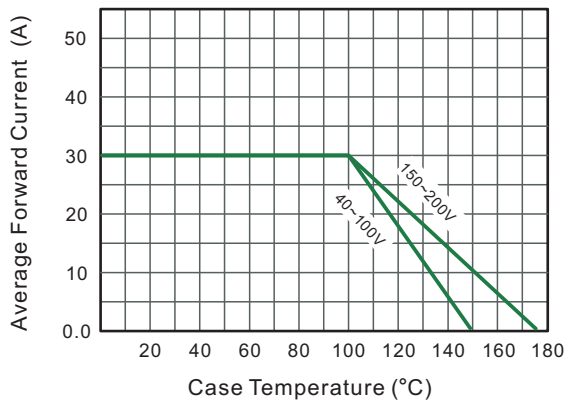

Fig.2 Typical Reverse Characteristics

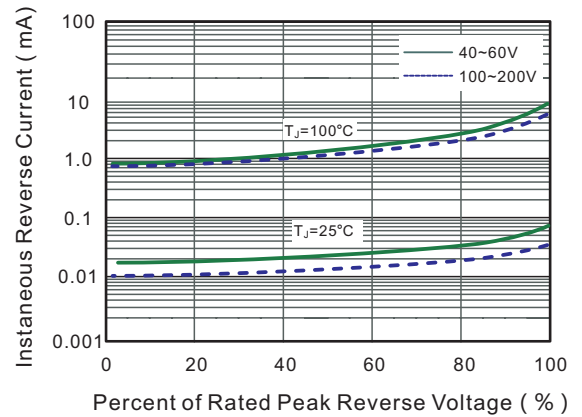

Fig.3 Typical Forward Characteristic(per leg)

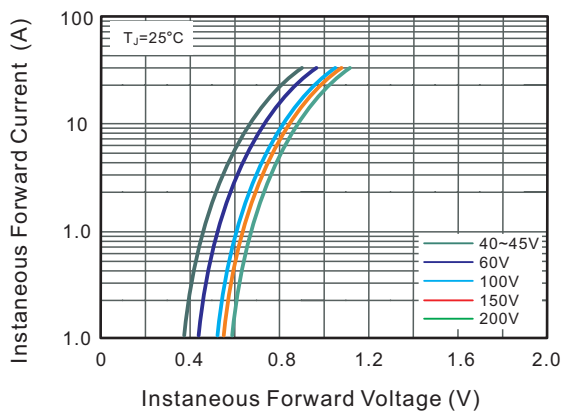
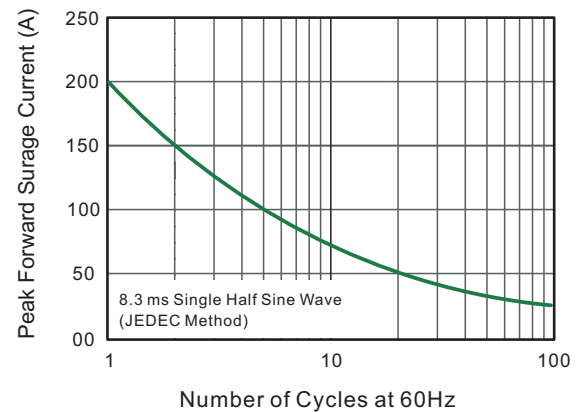

Fig.4 Maximum Non-Repetitive Peak Forward Surge Current





Package Outline
Through Hole Package ; 3 leads

TO-220-3L

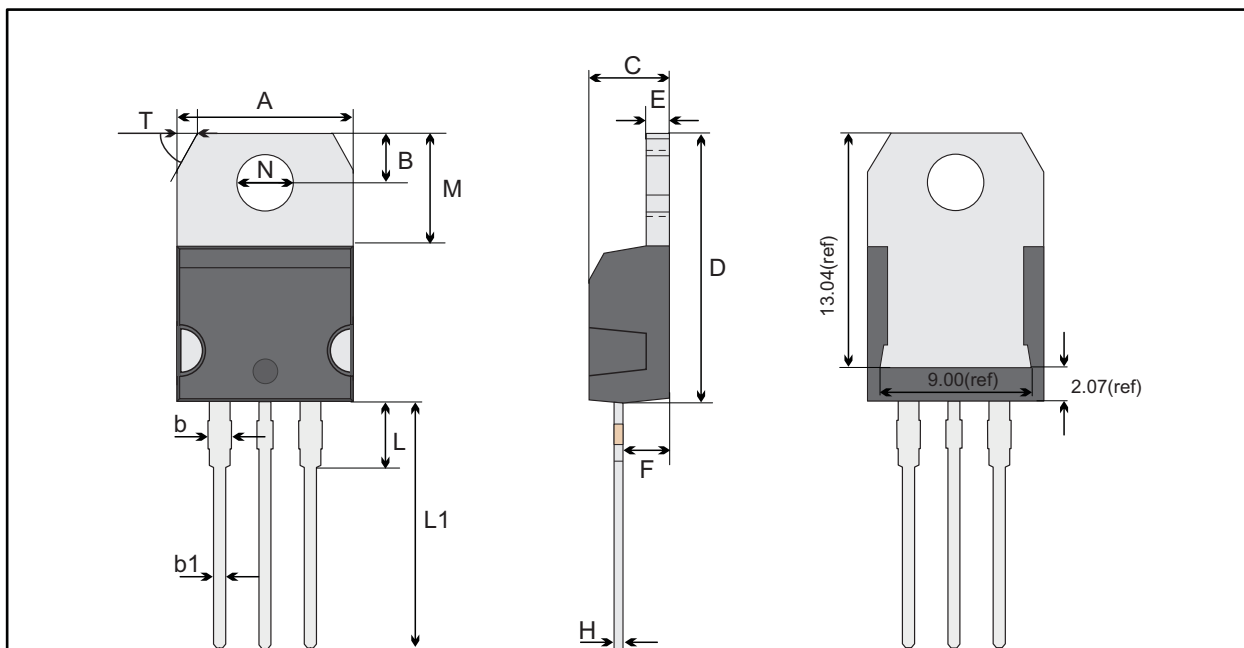

TO-220-3L mechanical data

UNIT		A	B	b	b1	C	D	E	F	G	H	L	L1	M	N	T
mm	max	10.28	2.84	1.67	0.9	4.65	15.54	1.37	2.79	2.64	0.6	3.88	13.13	6.39	3.82 typ.	1.19 58° ref.
	typ	10.18	2.74	1.47	0.8	4.45	15.34	1.27	2.59	2.54	0.5	3.68	12.93	6.19		
	min	10.08	2.64	1.27	0.7	4.25	15.14	1.17	2.39	2.44	0.4	3.48	12.73	5.99		
mil	max	405	112	66	35	183	612	54	110	104	24	153	517	252	150 typ.	47 58° ref.
	typ	401	108	58	31	175	604	50	102	100	20	145	509	244		
	min	397	104	50	28	167	596	46	94	92	16	137	501	236		

Marking Diagram

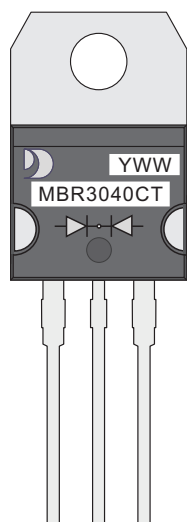

YWW: Date Code
Y: Years(0~9)
WW: Week
MBR3040CT: Product name
(NOTE: The weekly code is based on the actual number of weeks in the calendar year.)



Important Notice and Disclaimer

Jingdao Microelectronics reserves the right to make changes to this document and its products and specifications at any time without notice. Customers should obtain and confirm the latest product information and specifications before final design, purchase or use.

Jingdao Microelectronics makes no warranty, representation or guarantee regarding the suitability of its products for any particular purpose, not does Jingdao Microelectronics assume any liability for application assistance or customer product design.

Jingdao Microelectronics does not warrant or accept any liability with products which are purchased or used for any unintended or unauthorized application.

No license is granted by implication or otherwise under any intellectual property rights of Jingdao Microelectronics.

Jingdao Microelectronics products are not authorized for use as critical components in life support devices or systems without express written approval of Jingdao Microelectronics.