

## MIC5205 150mA Low-Noise LDO Regulator

### Features

- Ultra-low-noise output
- High output voltage accuracy
- Guaranteed 150mA output
- Low quiescent current
- Low dropout voltage
- Extremely tight load and line regulation
- Very low temperature coefficient
- Current and thermal limiting
- Reverse-battery protection
- “Zero” off-mode current
- Logic-controlled electronic enable

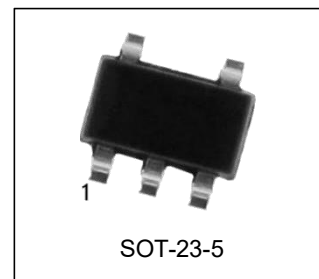

### Ordering Information

DEVICE	Package Type	MARKING	Packing	Packing Qty
MIC5205M5-ADJ/TR	SOT-23-5	LBAA	REEL	3000pcs/reel
MIC5205M5-2.5/TR	SOT-23-5	LB25	REEL	3000pcs/reel
MIC5205M5-2.7/TR	SOT-23-5	LB27	REEL	3000pcs/reel
MIC5205M5-2.8/TR	SOT-23-5	LB28	REEL	3000pcs/reel
MIC5205M5-2.9/TR	SOT-23-5	LB29	REEL	3000pcs/reel
MIC5205M5-3.0/TR	SOT-23-5	LB30	REEL	3000pcs/reel
MIC5205M5-3.3/TR	SOT-23-5	LB33	REEL	3000pcs/reel
MIC5205M5-3.6/TR	SOT-23-5	LB36	REEL	3000pcs/reel
MIC5205M5-3.8/TR	SOT-23-5	LB38	REEL	3000pcs/reel
MIC5205M5-4.0/TR	SOT-23-5	LB40	REEL	3000pcs/reel
MIC5205M5-5.0/TR	SOT-23-5	LB50	REEL	3000pcs/reel

## General Description

The MIC5205 is an efficient linear voltage regulator with ultra- low-noise output, very low dropout voltage (typically 17mV at light loads and 165mV at 150mA), and very low ground current (600μA at 100mA output). The MIC5205 offers better than 1% initial accuracy.

Designed especially for hand-held, battery-powered devices, the MIC5205 includes a CMOS or TTL compatible enable/ shutdown control input. When shutdown, power consumption drops nearly to zero. Regulator ground current increases only slightly in dropout, further prolonging battery life.

Key MIC5205 features include a reference bypass pin to improve its already excellent low-noise performance, re- versed-battery protection, current limiting, and overtemperature shutdown.

The MIC5205 is available in fixed and adjustable output voltage versions in a small SOT-23-5 package.

## Applications

- Cellular telephones
- Laptop, notebook, and palmtop computers
- Battery-powered equipment regulation/switching
- PCMCIA VCC and VPP
- Consumer/personal electronics
- SMPS post-regulator/dc-to-dc modules
- High-efficiency linear power supplies

## Typical Application

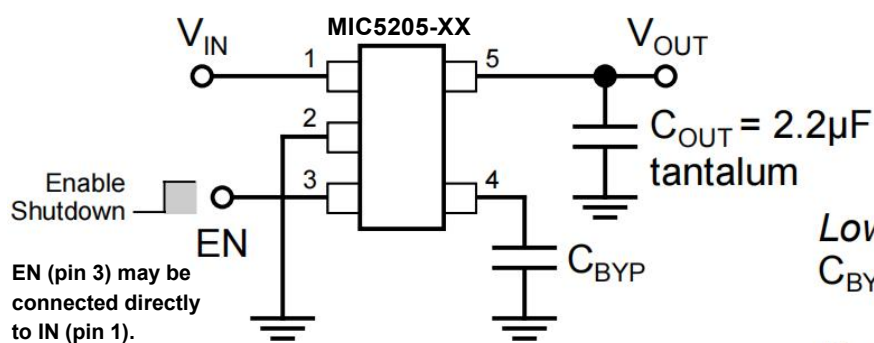

*Low-Noise Operation:*  
 $C_{BYP} = 470\text{pF}$ ,  $C_{OUT} \geq 2.2\mu\text{F}$

*Basic Operation:*  
 $C_{BYP} = \text{not used}$ ,  $C_{OUT} \geq 1\mu\text{F}$

Ultra-Low-Noise Regulator Application

## Pin Configuration

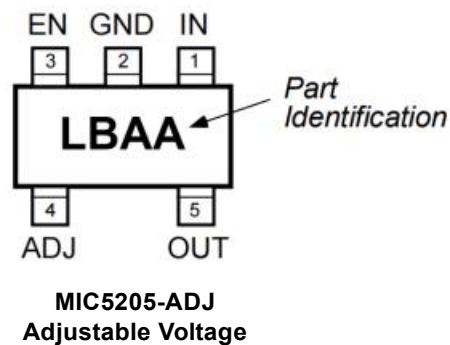
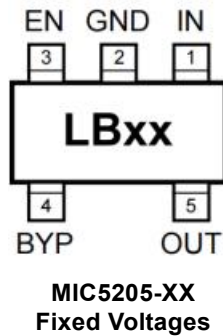

## Pin Description

MIC5205-x.x (fixed)	MIC5205 (adjustable)	Pin Name	Pin Function
1	1	IN	Supply Input
2	2	GND	Ground
3	3	EN	Enable/Shutdown (Input): CMOS compatible input. Logic high = enable, logic low or open = shutdown.
4	-	BYP	Reference Bypass: Connect external 470pF capacitor to GND to reduce output noise. May be left open.
-	4	ADJ	Adjust (Input): Adjustable regulator feedback input. Connect to resistor voltage divider.
5	5	OUT	Regulator Output

## Absolute Maximum Ratings (Note 1)

parameter	Value
Supply Input Voltage ( $V_{IN}$ )	-20V to +20V
Enable Input Voltage ( $V_{EN}$ )	-20V to +20V
Power Dissipation ( $P_D$ )	internally Limited, <b>Note 3</b>
Lead Temperature (soldering, 10 sec.)	245°C
Junction Temperature ( $T_J$ )	-40°C to +85 °C
Storage Temperature ( $T_S$ )	-65°C to +150°C

## Operating Ratings (Note 2)

parameter	Value
Input Voltage ( $V_{IN}$ )	+2.5V to +16V
Enable Input Voltage ( $V_{EN}$ )	0V to $V_{IN}$
Junction Temperature ( $T_J$ )	-40°C to +85 °C
Thermal Resistance, SOT-23-5 ( $\theta_{JA}$ )	Note 3

## Electrical Characteristics

$V_{IN} = V_{OUT} + 1V$ ;  $I_L = 100\mu A$ ;  $C_L = 1.0\mu F$ ;  $V_{EN} \geq 2.0V$ ;  $T_J = 25^\circ C$ , **bold** values indicate  $-40^\circ C \leq T_J \leq +125^\circ C$ ; unless noted.

Symbol	Parameter	Conditions	Min	Typical	Max	Units
$V_O$	Output Voltage Accuracy	variation from specified $V_{OUT}$	-1 <b>-3.5</b>		1 <b>3.5</b>	% %
$\Delta V_O / \Delta T$	Output Voltage Temperature Coefficient	Note 4		<b>40</b>		ppm/ $^\circ C$
$V_O / V_O$	Line Regulation	$V_{IN} = V_{OUT} + 1V$ to 16V		0.004	0.012 <b>0.05</b>	% / V % / V
$V_O / V_O$	Load Regulation	$I_L = 0.1mA$ to 150mA, Note 5		0.02	0.2 <b>0.5</b>	% %
$V_{IN} - V_O$	Dropout Voltage, Note 6	$I_L = 100\mu A$		10	50 <b>70</b>	mV mV
		$I_L = 50mA$		110	150 <b>230</b>	mV mV
		$I_L = 100mA$		140	250 <b>300</b>	mV mV
		$I_L = 150mA$		165	275 <b>350</b>	mV mV
$I_{GND}$	Quiescent Current	$V_{EN} \leq 0.4V$ (shutdown)		0.01	1	$\mu A$
		$V_{EN} \leq 0.18V$ (shutdown)			<b>5</b>	$\mu A$
$I_{GND}$	Ground Pin Current, Note 7	$V_{EN} \leq 2.0V$ , $I_L = 100\mu A$		80	125 <b>150</b>	$\mu A$ $\mu A$
		$I_L = 50mA$		350	600 <b>800</b>	$\mu A$ $\mu A$
		$I_L = 100mA$		600	1000 <b>1500</b>	$\mu A$ $\mu A$
		$I_L = 150mA$		1300	1900 <b>2500</b>	$\mu A$ $\mu A$
PSRR	Ripple Rejection	frequency = 100Hz, $I_L = 100\mu A$		75		dB
$I_{LIMIT}$	Current Limit	$V_{OUT} = 0V$		<b>320</b>	500	mA
$\Delta V_O / \Delta P_D$	Thermal Regulation	Note 8		0.05		%/W
$e_{no}$	Output Noise	$I_L = 50mA$ , $C_L = 2.2\mu F$ , 470pF from BYP to GND		260		nV/ $\sqrt{Hz}$
<b>ENABLE Input</b>						
$V_{IL}$	Enable Input Logic-Low Voltage	regulator shutdown			0.4 <b>0.18</b>	V V
$V_{IH}$	Enable Input Logic-High Voltage	regulator enabled	<b>2.0</b>			V
$I_{IL}$ $I_{IH}$	Enable Input Current	$V_{IL} \leq 0.4V$	2	0.01	-1	$\mu A$
		$V_{IL} \leq 0.18V$				
		$V_{IH} \leq 2.0V$		5	20	$\mu A$
		$V_{IH} \leq 2.0V$				
					<b>25</b>	$\mu A$

**Note 1.** Exceeding the absolute maximum rating may damage the device.

**Note 2.** The device is not guaranteed to function outside its operating rating.

**Note 3:** The maximum allowable power dissipation at any  $T_A$  (ambient temperature) is  $P_{D(max)} = (T_{J(max)} - T_A) / \theta_{JA}$ . Exceeding the maximum allowable power dissipation will result in excessive die temperature, and the regulator will go into thermal shutdown. The  $\theta_{JA}$  of the MIC5205-xx (all versions) is 220 $^\circ C/W$  mounted on a PC board (see "Thermal Considerations" section for further details).

**Note 4:** Output voltage temperature coefficient is defined as the worst case voltage change divided by the total temperature range.

**Note 5:** Regulation is measured at constant junction temperature using low duty cycle testing. Parts are tested for load regulation in the load range from 0.1mA to 150mA. Changes in output voltage due to heating effects are covered by the thermal regulation specification.

**Note 6:** Dropout Voltage is defined as the input to output differential at which the output voltage drops 2% below its nominal value measured at 1V differential.

**Note 7:** Ground pin current is the regulator quiescent current plus pass transistor base current. The total current drawn from the supply is the sum of the load current plus the ground pin current.

**Note 8:** Thermal regulation is defined as the change in output voltage at a time "t" after a change in power dissipation is applied, excluding load or line regulation effects. Specifications are for a 150mA load pulse at  $V_{IN} = 16V$  for  $t = 10ms$ .

Typical Characteristics

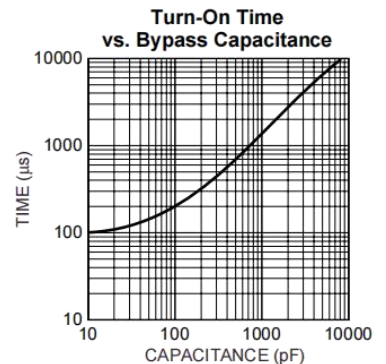
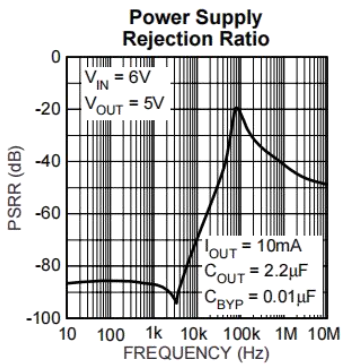
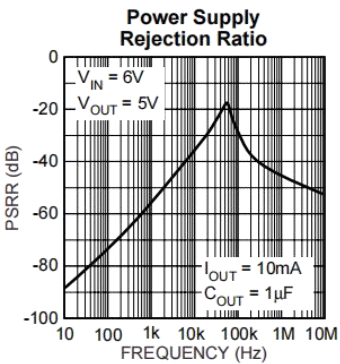
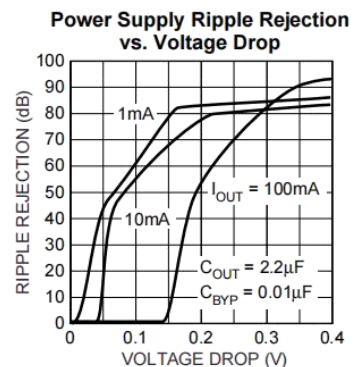
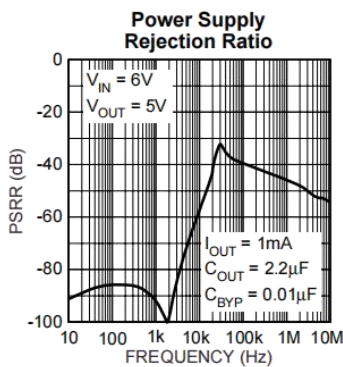
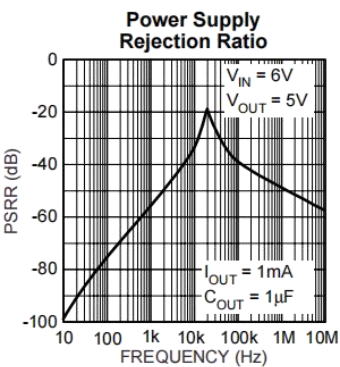
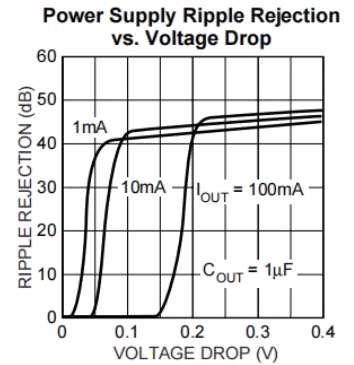
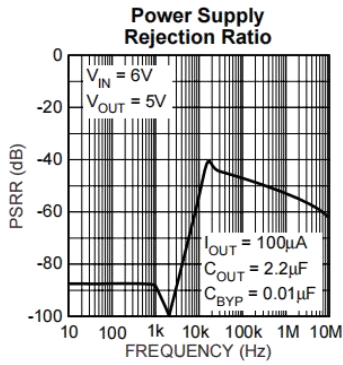
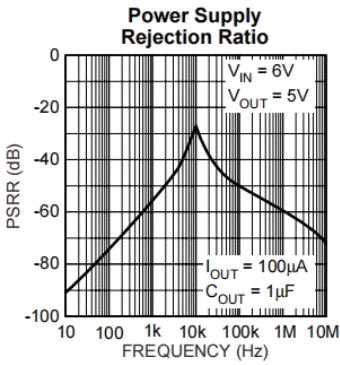

Typical Characteristics

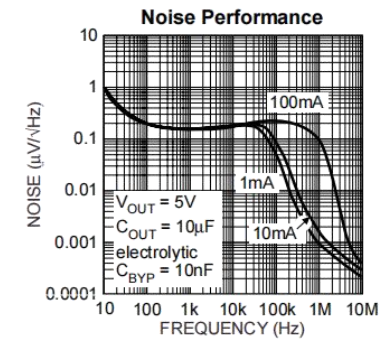
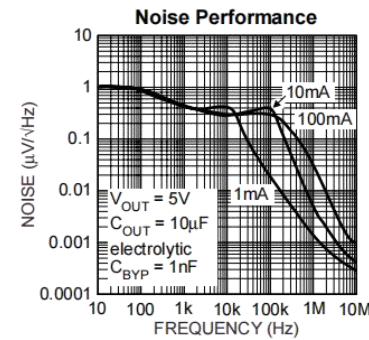
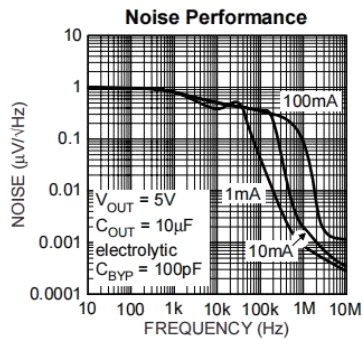
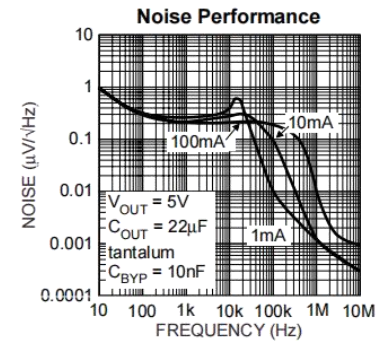
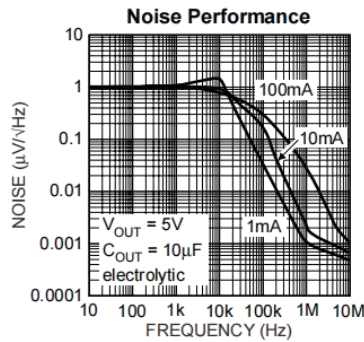
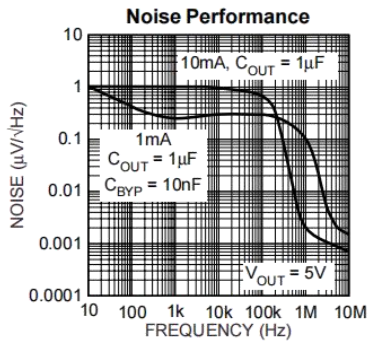
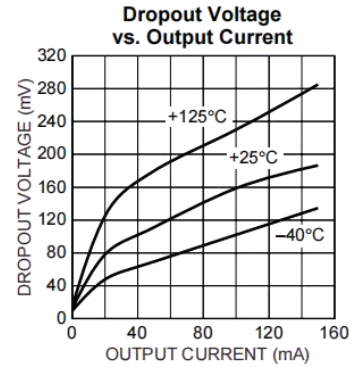
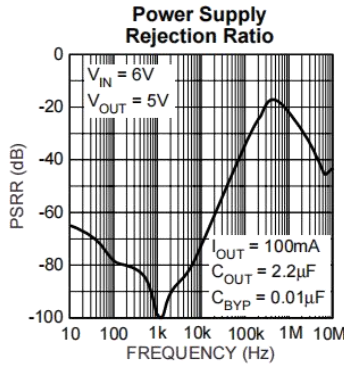
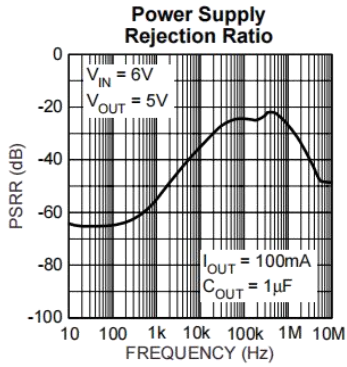

**Block Diagrams**

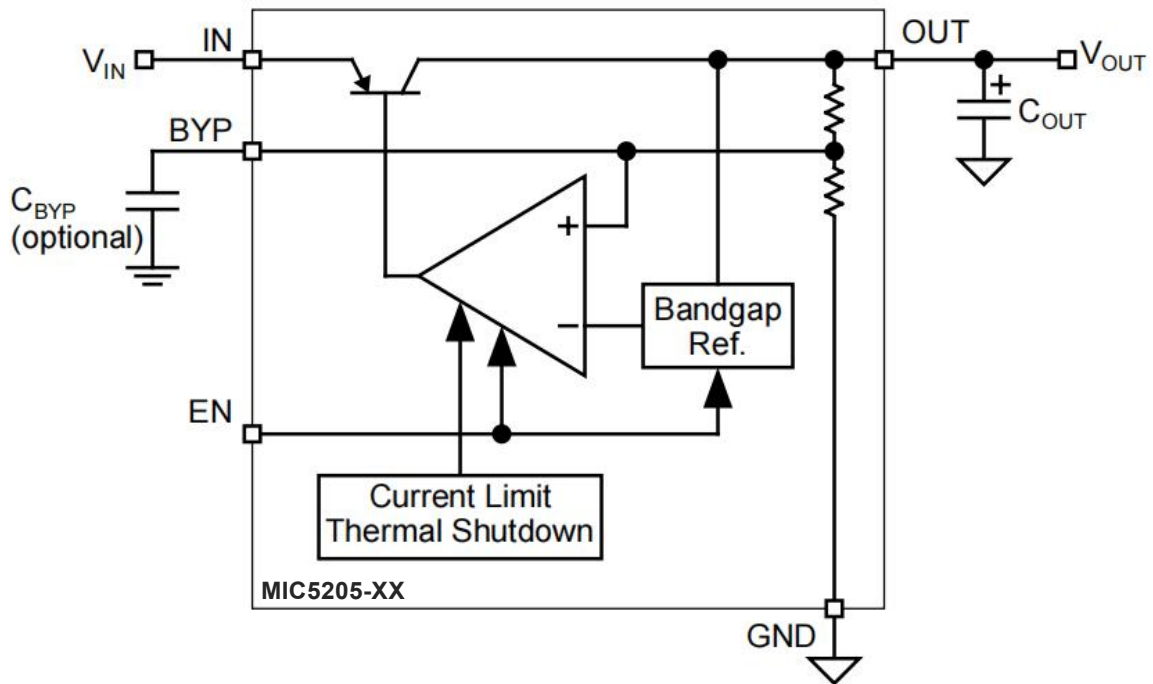

Ultra-Low-Noise Fixed Regulator

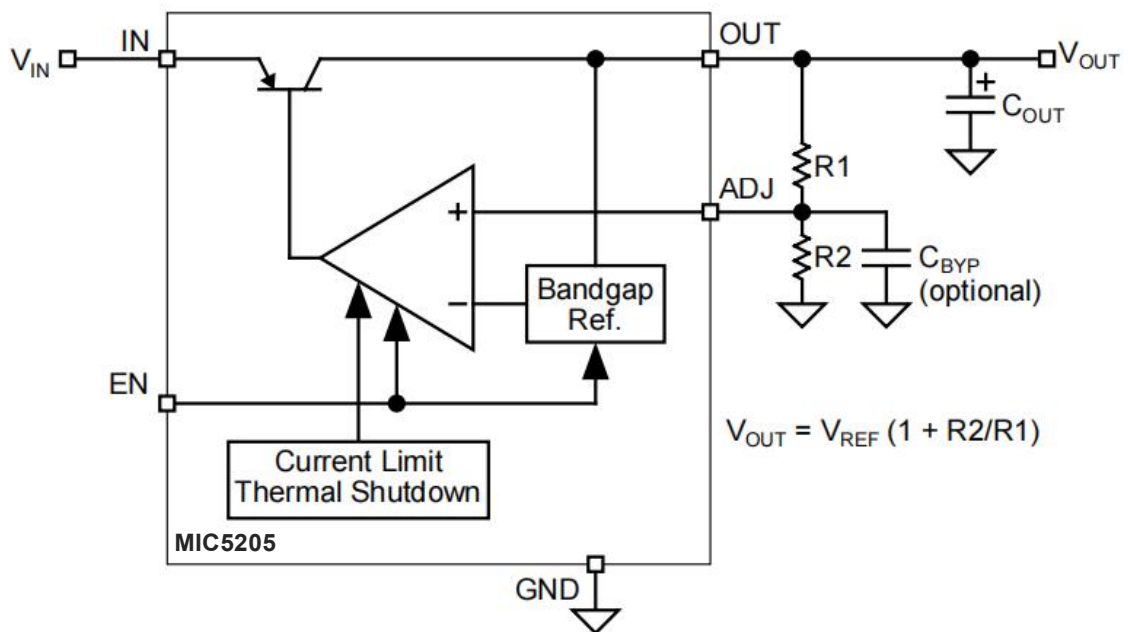

Ultra-Low-Noise Adjustable Regulator

## Applications Information

### Enable/Shutdown

Forcing EN (enable/shutdown) high (> 2V) enables the regulator. EN is compatible with CMOS logic gates. If the enable/shutdown feature is not required, connect EN (pin 3) to IN (supply input, pin 1). See Figure 1.

### Input Capacitor

A 1 $\mu$ F capacitor should be placed from IN to GND if there is more than 10 inches of wire between the input and the ac filter capacitor or if a battery is used as the input.

### Reference Bypass Capacitor

BYP (reference bypass) is connected to the internal voltage reference. A 470pF capacitor (CBYP) connected from BYP to GND quiets this reference, providing a significant reduction in output noise. CBYP reduces the regulator phase margin;

when using CBYP, output capacitors of 2.2 $\mu$ F or greater are generally required to maintain stability.

The start-up speed of the MIC5205 is inversely proportional to the size of the reference bypass capacitor. Applications requiring a slow ramp-up of output voltage should consider larger values of CBYP. Likewise, if rapid turn-on is necessary, consider omitting CBYP.

If output noise is not a major concern, omit CBYP and leave BYP open.

### Output Capacitor

An output capacitor is required between OUT and GND to prevent oscillation. The minimum size of the output capacitor is dependent upon whether a reference bypass capacitor is used. 1.0 $\mu$ F minimum is recommended when CBYP is not used (see Figure 2). 2.2 $\mu$ F minimum is recommended when CBYP is 470pF (see Figure 1). Larger values improve the regulator's transient response. The output capacitor value may be increased without limit.

The output capacitor should have an ESR (effective series resistance) of about 5 $\Omega$  or less and a resonant frequency above 1MHz. Ultra-low-ESR capacitors can cause a low amplitude oscillation on the output and/or underdamped transient response. Most tantalum or aluminum electrolytic capacitors are adequate; film types will work, but are more expensive. Since many aluminum electrolytics have electrolytes that freeze at about  $-30^{\circ}\text{C}$ , solid tantalums are recommended for operation below  $-25^{\circ}\text{C}$ .

At lower values of output current, less output capacitance is required for output stability. The capacitor can be reduced to 0.47 $\mu$ F for current below 10mA or 0.33 $\mu$ F for currents below 1mA.

### No-Load Stability

The MIC5205 will remain stable and in regulation with no load (other than the internal voltage divider) unlike many other voltage regulators. This is especially important in CMOS RAM keep-alive applications.



## Thermal Considerations

The MIC5205 is designed to provide 150mA of continuous current in a very small package. Maximum power dissipation can be calculated based on the output current and the voltage drop across the part. To determine the maximum power dissipation of the package, use the junction-to-ambient thermal resistance of the device and the following basic equation:

$$P_{D(max)} \left( \frac{T_{J(max)}}{\theta_{JA}} - T_A \right)$$

$T_{J(max)}$  is the maximum junction temperature of the die, 125°C, and  $T_A$  is the ambient operating temperature.  $\theta_{JA}$  is layout dependent; Table 1 shows examples of junction-to-ambient thermal resistance for the MIC5205.

Package	$\theta_{JA}$ Recommended Minimum Footprint	$\theta_{JA}$ 1" Square Copper Clad	$\theta_{JC}$
SOT-23-5 (M5)	220°C/W	170°C/W	130°C/W

Table 1. SOT-23-5 Thermal Resistance

The actual power dissipation of the regulator circuit can be determined using the equation:

$$P_D = (V_{IN} - V_{OUT})I_{OUT} + V_{IN} I_{GND}$$

Substituting  $P_{D(max)}$  for  $P_D$  and solving for the operating conditions that are critical to the application will give the maximum operating conditions for the regulator circuit. For example, when operating the MIC5205M5-3.3 at room temperature with a minimum footprint layout, the maximum input voltage for a set output current can be determined as follows:

$$P_{D(max)} = \frac{(125^\circ\text{C} - 25^\circ\text{C})}{220^\circ\text{C}/\text{W}}$$

$$P_{D(max)} = 455\text{mW}$$

The junction-to-ambient thermal resistance for the minimum footprint is 220°C/W, from Table 1. The maximum power dissipation must not be exceeded for proper operation. Using the output voltage of 3.3V and an output current of 150mA, the maximum input voltage can be determined. From the Electrical Characteristics table, the maximum ground current for 150mA output current is 2500µA or 2.5mA.

$$455\text{mW} = (V_{IN} - 3.3\text{V}) 150\text{mA} + V_{IN} \cdot 2.5\text{mA}$$

$$455\text{mW} = V_{IN} \cdot 150\text{mA} - 495\text{mW} + V_{IN} \cdot 2.5\text{mA}$$

$$950\text{mW} = V_{IN} \cdot 152.5\text{mA}$$

$$V_{IN(max)} = 6.23\text{V}$$

Therefore, a 3.3V application at 150mA of output current can accept a maximum input voltage of 6.2V in a SOT-23-5 package. For a full discussion of heat sinking and thermal effects on voltage regulators, refer to the Regulator Thermals section of Micrel's Designing with Low-Dropout Voltage Regulators handbook.

## Fixed Regulator Applications

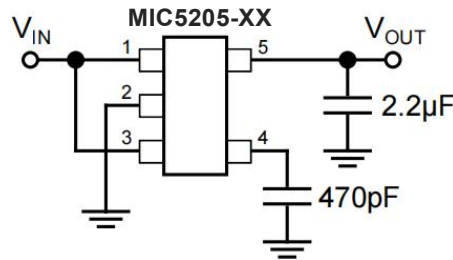

**Figure 1. Ultra-Low-Noise Fixed Voltage Application**

Figure 1 includes a 470pF capacitor for low-noise operation and shows EN (pin 3) connected to IN (pin 1) for an application where enable/shutdown is not required.  $C_{OUT} = 2.2\mu\text{F}$  minimum.

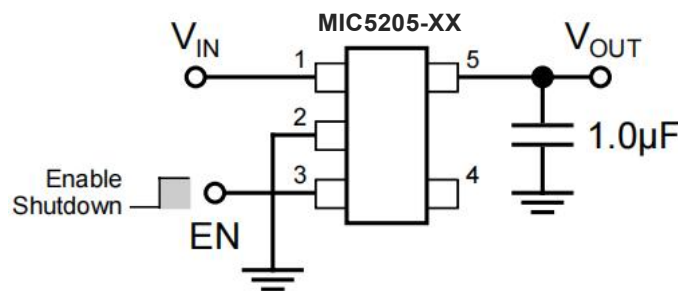

**Figure 2. Low-Noise Fixed Voltage Application**

Figure 2 is an example of a low-noise configuration where  $C_{BYP}$  is not required.  $C_{OUT} = 1\mu\text{F}$  minimum.

## Adjustable Regulator Applications

The MIC5205M5 can be adjusted to a specific output voltage by using two external resistors (Figure 3). The resistors set the output voltage based on the following equation:

$$V_{OUT} = 1.242\text{V} \times \left( \frac{R2}{R1} + 1 \right)$$

This equation is correct due to the configuration of the bandgap reference. The bandgap voltage is relative to the output, as seen in the block diagram. Traditional regulators normally have the reference voltage relative to ground and have a different  $V_{OUT}$  equation.

Resistor values are not critical because ADJ (adjust) has a high input impedance, but for best results use resistors of 470kΩ or less. A capacitor from ADJ to ground provides greatly improved noise performance.

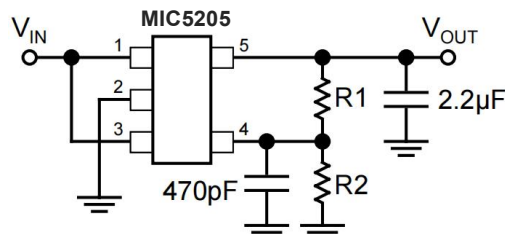

**Figure 3. Ultra-Low-Noise Adjustable Voltage Application**

Figure 3 includes the optional 470pF noise bypass capacitor from ADJ to GND to reduce output noise.

### Dual-Supply Operation

When used in dual supply systems where the regulator load is returned to a negative supply, the output voltage must be diode clamped to ground.

**Physical Dimensions**

SOT-23-5

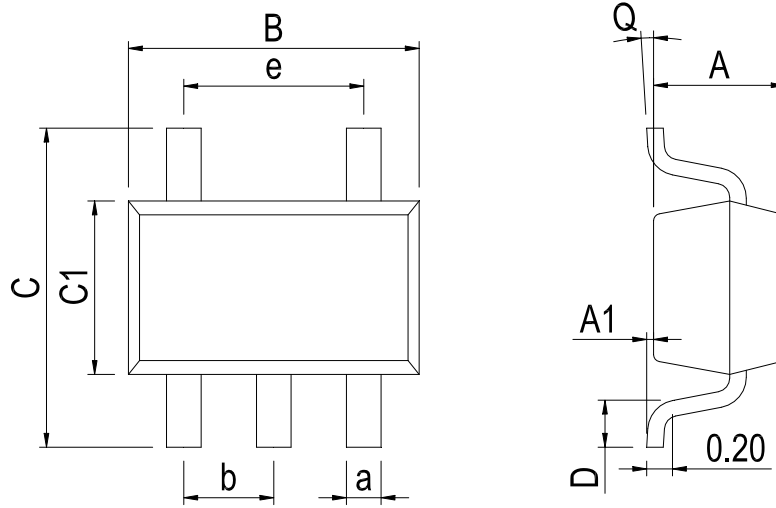

Dimensions In Millimeters(SOT-23-5)										
Symbol:	A	A1	B	C	C1	D	Q	a	b	e
Min:	1.05	0.00	2.82	2.65	1.50	0.30	0°	0.30	0.95 BSC	1.90 BSC
Max:	1.15	0.15	3.02	2.95	1.70	0.60	8°	0.40		

## Revision History

DATE	REVISION	PAGE
2020-6-9	New	1-13
2023-7-24	Update encapsulation type、 Update Lead Temperature、 Update DEVICE	1、 3

**IMPORTANT STATEMENT:**

Huaguan Semiconductor reserves the right to change its products and services without notice. Before ordering, the customer shall obtain the latest relevant information and verify whether the information is up to date and complete. Huaguan Semiconductor does not assume any responsibility or obligation for the altered documents.

Customers are responsible for complying with safety standards and taking safety measures when using Huaguan Semiconductor products for system design and machine manufacturing. You will bear all the following responsibilities: Select the appropriate Huaguan Semiconductor products for your application; Design, validate and test your application; Ensure that your application meets the appropriate standards and any other safety, security or other requirements. To avoid the occurrence of potential risks that may lead to personal injury or property loss.

Huaguan Semiconductor products have not been approved for applications in life support, military, aerospace and other fields, and Huaguan Semiconductor will not bear the consequences caused by the application of products in these fields. All problems, responsibilities and losses arising from the user's use beyond the applicable area of the product shall be borne by the user and have nothing to do with Huaguan Semiconductor, and the user shall not claim any compensation liability against Huaguan Semiconductor by the terms of this Agreement.

The technical and reliability data (including data sheets), design resources (including reference designs), application or other design suggestions, network tools, safety information and other resources provided for the performance of semiconductor products produced by Huaguan Semiconductor are not guaranteed to be free from defects and no warranty, express or implied, is made. The use of testing and other quality control technologies is limited to the quality assurance scope of Huaguan Semiconductor. Not all parameters of each device need to be tested.

The documentation of Huaguan Semiconductor authorizes you to use these resources only for developing the application of the product described in this document. You have no right to use any other Huaguan Semiconductor intellectual property rights or any third party intellectual property rights. It is strictly forbidden to make other copies or displays of these resources. You should fully compensate Huaguan Semiconductor and its agents for any claims, damages, costs, losses and debts caused by the use of these resources. Huaguan Semiconductor accepts no liability for any loss or damage caused by infringement.