

## ZENER DIODE

### FEATURES

- Planar Die Construction
- Sealed Glass Case
- Smaller voltage tolerances and higher Zener voltages are upon request
- Surface Mount device

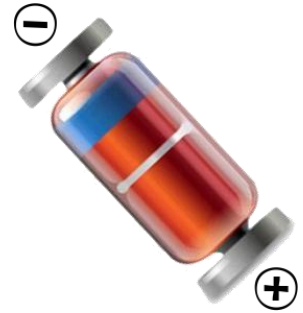

LL-34

### MECHANICAL DATA

- Case: LL-34
- Case Material: Glass
- Polarity: Color band denotes cathode end
- Approx. Weight: 0.05 grams

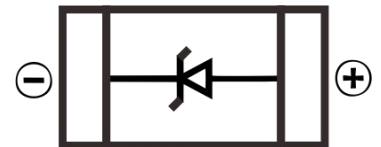

### MAXIMUM RATINGS ( $T_A = 25^\circ\text{C}$ unless otherwise noted)

Parameter	Symbol	Value	Unit
Forward Voltage @ $I_F = 200\text{mA}$	$V_F$	1.5	V
Power Dissipation	$P_D$	500	mW
Thermal Resistance From Junction To Ambient	$R_{\theta JA}$	300	K/W
Junction Temperature	$T_J$	175	$^\circ\text{C}$
Storage Temperature	$T_{STG}$	-55 ~ +175	$^\circ\text{C}$

## ZENER DIODE

### ELECTRICAL CHARACTERISTICS (T<sub>A</sub> = 25°C unless otherwise specified)

f = 1kHz	Zener Voltage Range <sup>(1)</sup>			Maximum Zener Impedance			Reverse		Forward		Temp Coefficient of zener voltage	
	V <sub>Z</sub> @ I <sub>ZT</sub> <sup>(2)</sup>		I <sub>ZT</sub>	Z <sub>ZT</sub> @ I <sub>ZT</sub>	Z <sub>ZK</sub> @ I <sub>ZK</sub>	I <sub>ZK</sub>	I <sub>R</sub> (μA)		V <sub>R</sub>	I <sub>F</sub>	V <sub>F</sub>	TK <sub>Vz</sub>
	Nom(V)	Range(V)	(mA)	Ω		(mA)	T <sub>a</sub> =25°C	T <sub>a</sub> =125°C	(V)	(mA)	(V)	(%/K)
ZMM1 <sup>(3)</sup>	0.75	0.7-0.8	5	8	50	1.0	-	-	-	-	-	-0.26~-0.23
ZMM2V0	2.0	1.80~2.15	5	85	600	1.0	100	200	1.0	100	1.0	-0.09~-0.06
ZMM2V2	2.2	2.08~2.33	5	85	600	1.0	75	160	1.0	100	1.0	-0.09~-0.06
ZMM2V4	2.4	2.28~2.56	5	85	600	1.0	50	100	1.0	100	1.0	-0.09~-0.06
ZMM2V7	2.7	2.5~2.9	5	85	600	1.0	10	50	1.0	100	1.0	-0.09~-0.06
ZMM3V0	3.0	2.8~3.2	5	85	600	1.0	4	40	1.0	100	1.0	-0.08~-0.05
ZMM3V3	3.3	3.1~3.5	5	85	600	1.0	2	40	1.0	100	1.0	-0.08~-0.05
ZMM3V6	3.6	3.4~3.8	5	85	600	1.0	2	40	1.0	100	1.0	-0.08~-0.05
ZMM3V9	3.9	3.7~4.1	5	85	600	1.0	2	40	1.0	100	1.0	-0.08~-0.05
ZMM4V3	4.3	4.0~4.6	5	75	600	1.0	1	20	1.0	100	1.0	-0.06~-0.03
ZMM4V7	4.7	4.4~5.0	5	60	600	1.0	0.5	10	1.0	100	1.0	-0.05~+0.02
ZMM5V1	5.1	4.8~5.4	5	35	550	1.0	0.1	2	1.0	100	1.0	-0.02~+0.02
ZMM5V6	5.6	5.2~6.0	5	25	450	1.0	0.1	2	1.0	100	1.0	-0.05~+0.05
ZMM6V2	6.2	5.8~6.6	5	10	200	1.0	0.1	2	2.0	100	1.0	0.03~0.06
ZMM6V8	6.8	6.4~7.2	5	8	150	1.0	0.1	2	3.0	100	1.0	0.03~0.07
ZMM7V5	7.5	7.0~7.9	5	7	50	1.0	0.1	2	5.0	100	1.0	0.03~0.07
ZMM8V2	8.2	7.7~8.7	5	7	50	1.0	0.1	2	6.2	100	1.0	0.03~0.08
ZMM9V1	9.1	8.5~9.6	5	10	50	1.0	0.1	2	6.8	100	1.0	0.03~0.09
ZMM10	10	9.4~10.6	5	15	70	1.0	0.1	2	7.5	100	1.0	0.03~0.1
ZMM11	11	10.4~11.6	5	20	70	1.0	0.1	2	8.2	100	1.0	0.03~0.11
ZMM12	12	11.4~12.7	5	20	90	1.0	0.1	2	9.1	100	1.0	0.03~0.11
ZMM13	13	12.4~14.1	5	26	110	1.0	0.1	2	10	100	1.0	0.03~0.11
ZMM15	15	13.8~15.6	5	30	110	1.0	0.1	2	11	100	1.0	0.03~0.11
ZMM16	16	15.3~17.1	5	40	170	1.0	0.1	2	12	100	1.0	0.03~0.11
ZMM18	18	16.8~19.1	5	50	170	1.0	0.1	2	13	100	1.0	0.03~0.11
ZMM20	20	18.8~21.2	5	55	220	1.0	0.1	2	15	100	1.0	0.03~0.11
ZMM24	24	22.8~25.6	5	80	220	1.0	0.1	2	18	100	1.0	0.04~0.12
ZMM27	27	25.1~28.9	5	80	220	1.0	0.1	2	20	100	1.0	0.04~0.12
ZMM30	30	28~32	5	80	220	1.0	0.1	2	22	100	1.0	0.04~0.12
ZMM33	33	31~35	5	80	220	1.0	0.1	2	24	100	1.0	0.04~0.12
ZMM36	36	34~38	5	80	220	1.0	0.1	2	27	100	1.0	0.04~0.12
ZMM39	39	37~41	2.5	90	500	0.5	0.1	5	30	100	1.0	0.04~0.12
ZMM43	43	40~46	2.5	90	500	0.5	0.1	5	33	100	1.0	0.04~0.12
ZMM47	47	44~50	2.5	110	600	0.5	0.1	5	36	100	1.0	0.04~0.12
ZMM51	51	48~54	2.5	125	700	0.5	0.1	10	39	100	1.0	0.04~0.12
ZMM56	56	52~60	2.5	135	700	0.5	0.1	10	43	100	1.0	0.04~0.12
ZMM62	62	58~66	2.5	150	1000	0.5	0.1	10	47	100	1.0	0.04~0.12
ZMM68	68	64~72	2.5	200	1000	0.5	0.1	10	51	100	1.0	0.04~0.12
ZMM75	75	70~79	2.5	250	1000	0.5	0.1	10	56	100	1.0	0.04~0.12
ZMM82	82	77~87	2.5	300	1500	0.25	0.1	10	62	100	1.0	0.05~0.12
ZMM91	91	85~96	1	450	2000	0.1	0.1	10	68	100	1.0	0.05~0.12
ZMM100	100	94~106	1	450	5000	0.1	0.1	10	75	100	1.0	0.05~0.12
ZMM110	110	104~116	1	600	5000	0.1	0.1	10	82	100	1.0	0.05~0.12
ZMM120	120	114~127	1	800	5500	0.1	0.1	10	91	100	1.0	0.05~0.12
ZMM130	130	124~141	1	950	6000	0.1	0.1	10	100	100	1.0	0.05~0.12
ZMM150	150	138~156	1	1250	6500	0.1	0.1	10	110	100	1.0	0.05~0.12
ZMM160	160	153~171	1	1400	7000	0.1	0.1	10	120	100	1.0	0.05~0.12
ZMM180	180	168~191	1	1700	8500	0.1	0.1	10	130	100	1.0	0.05~0.12
ZMM200	200	188~212	1	2000	10000	0.1	0.1	10	150	100	1.0	0.05~0.12

1) Tested with pulses t<sub>p</sub> = 20 ms.

2) Valid provided that electrodes are kept at ambient temperature

3) The ZMM1 is a silicon diode with operation in forward direction. Hence, the index of all parameters should be "F" instead of "Z". Connect the cathode electrode to the negative pole.

ZENER DIODE

**Typical Characteristics**

**BREAKDOWN CHARACTERISTICS AT  $T_J = \text{CONSTANT}$  (PULSED)**

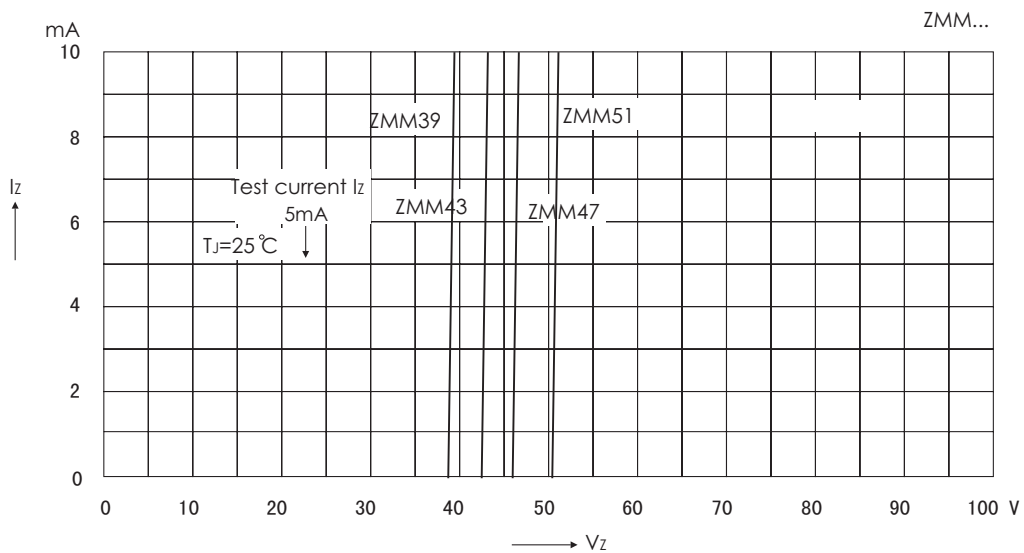
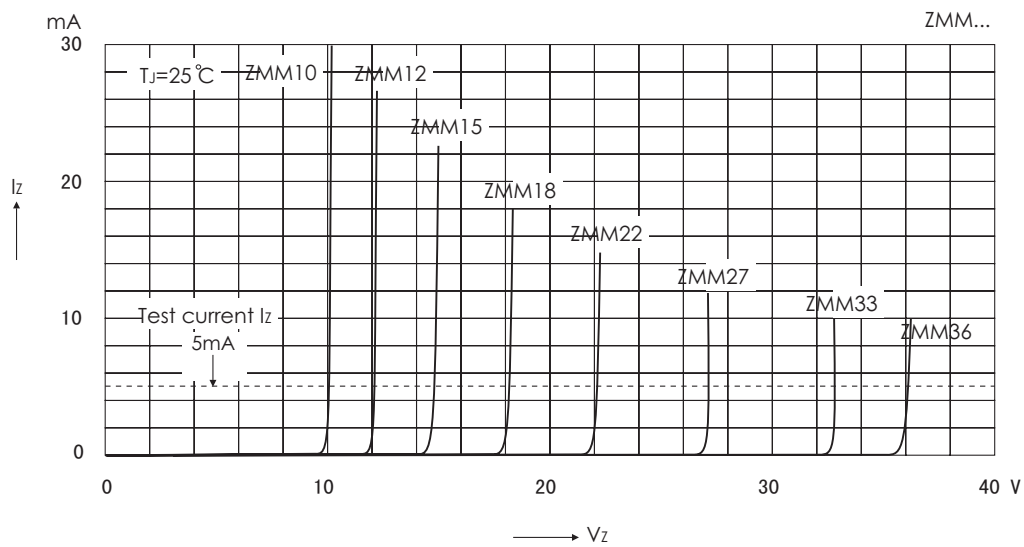
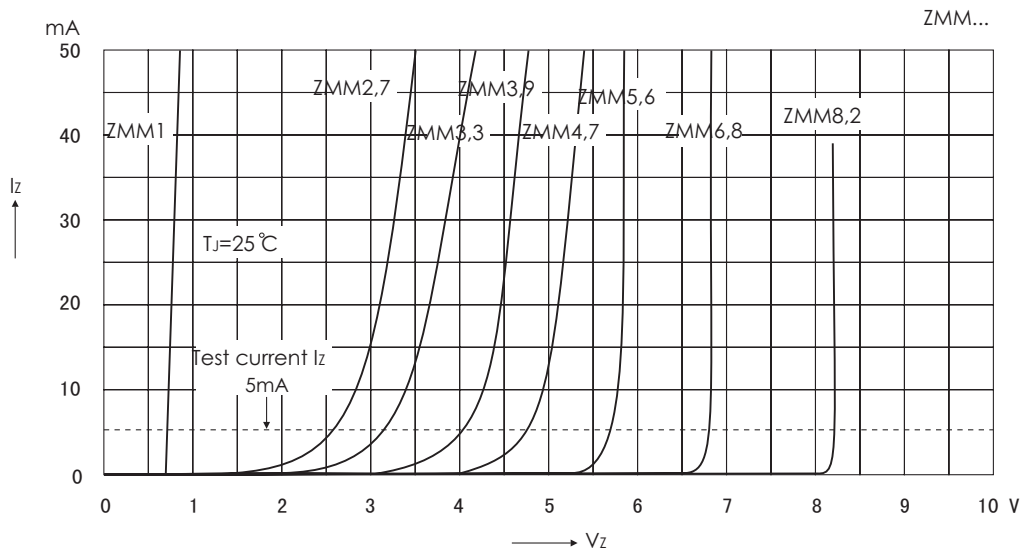

ZENER DIODE

Forward Characteristics

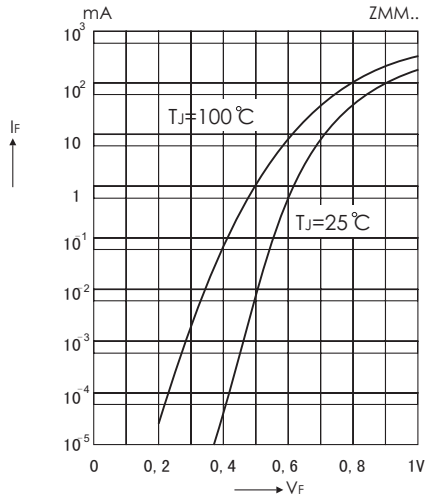

Admissible power dissipation versus ambient temperature

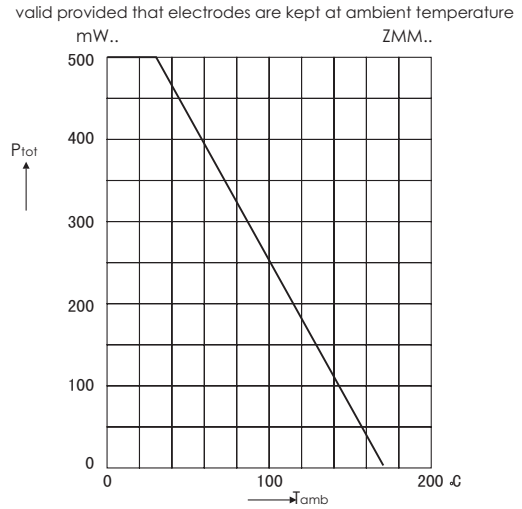

Pulse thermal resistance versus pulse duration

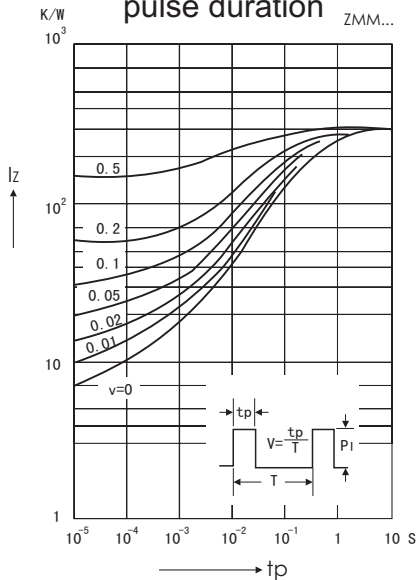

Dynamic resistance versus Zener current

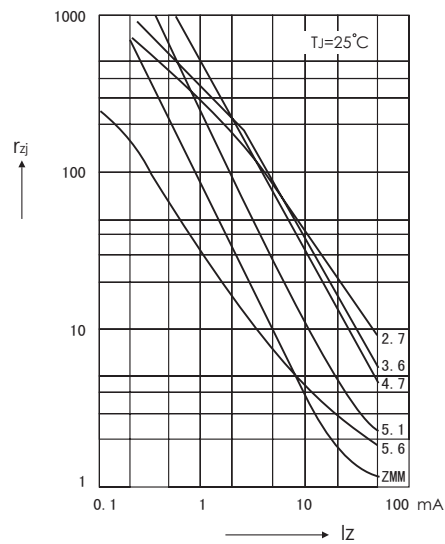

Capacitance versus Zener voltage

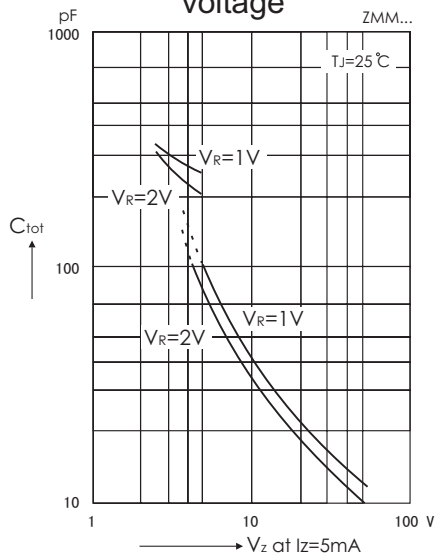

Dynamic resistance versus Zener current

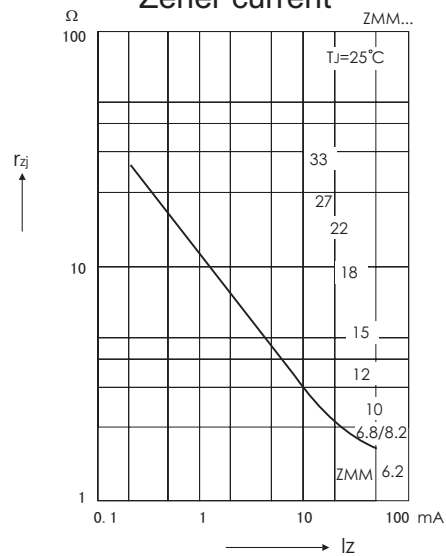

ZENER DIODE

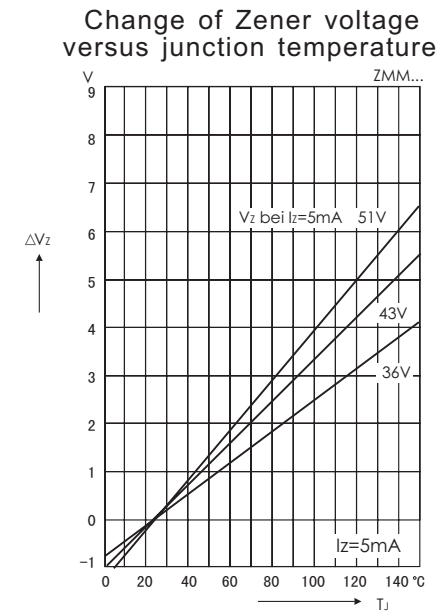
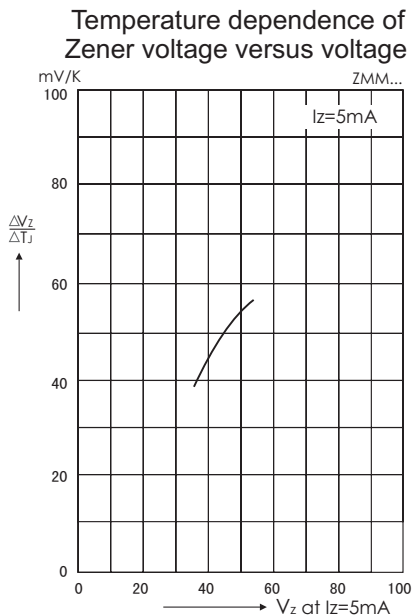
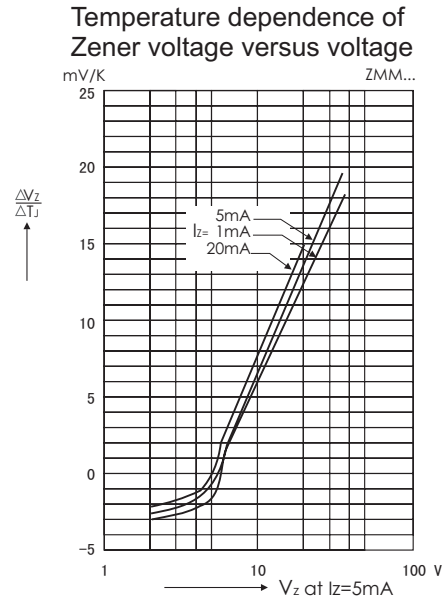
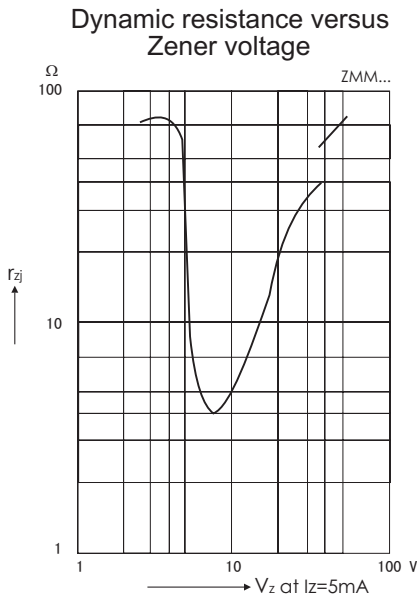
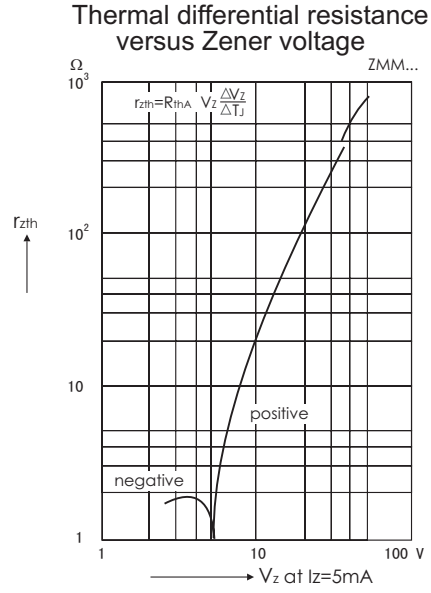
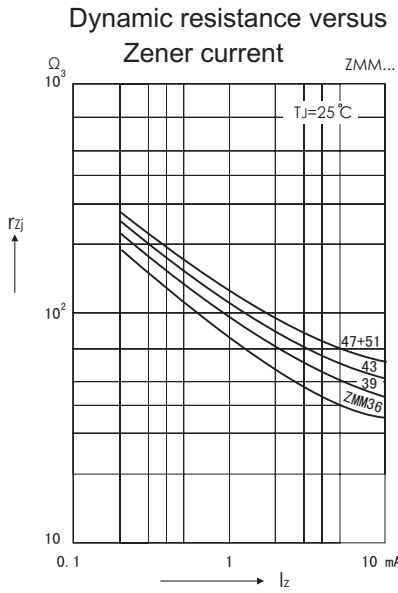

ZENER DIODE

Change of Zener voltage versus junction temperature

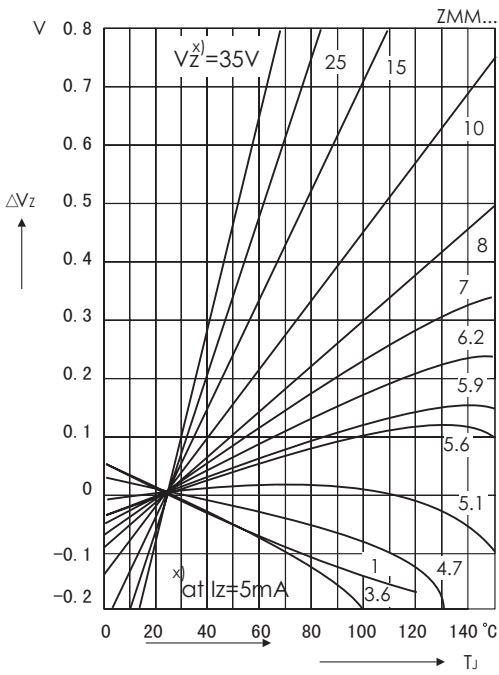

Change of Zener voltage from turn-on up to the point of thermal equilibrium versus Zener voltage

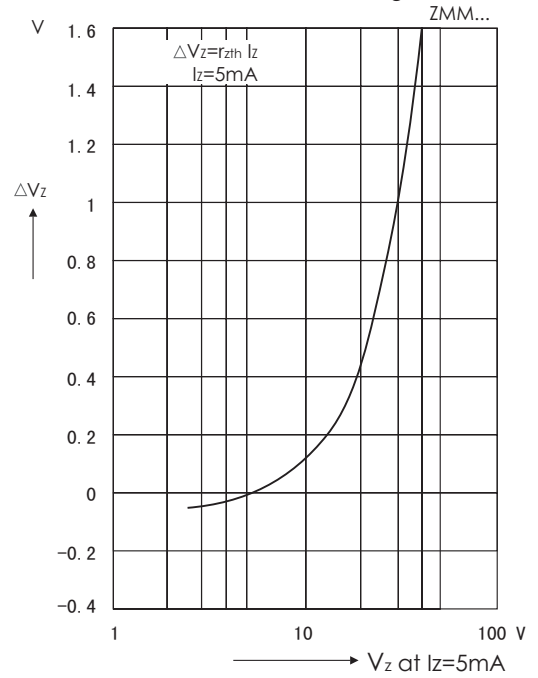

Change of Zener voltage from turn-on up to the point of thermal equilibrium versus Zener voltage

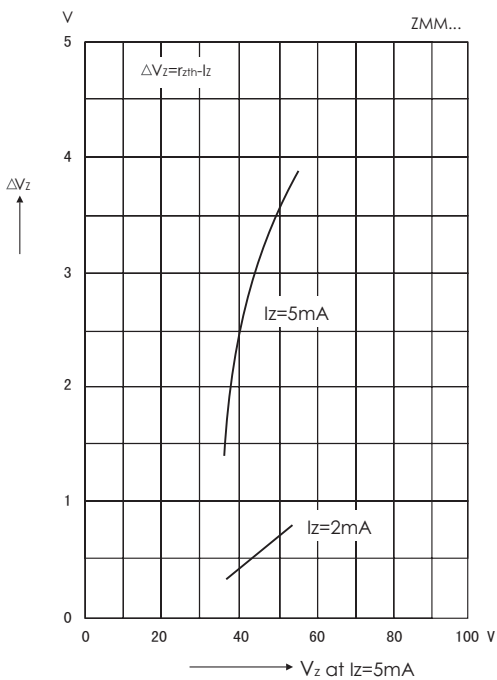

ZENER DIODE

**LL-34 Package Outline Dimensions**

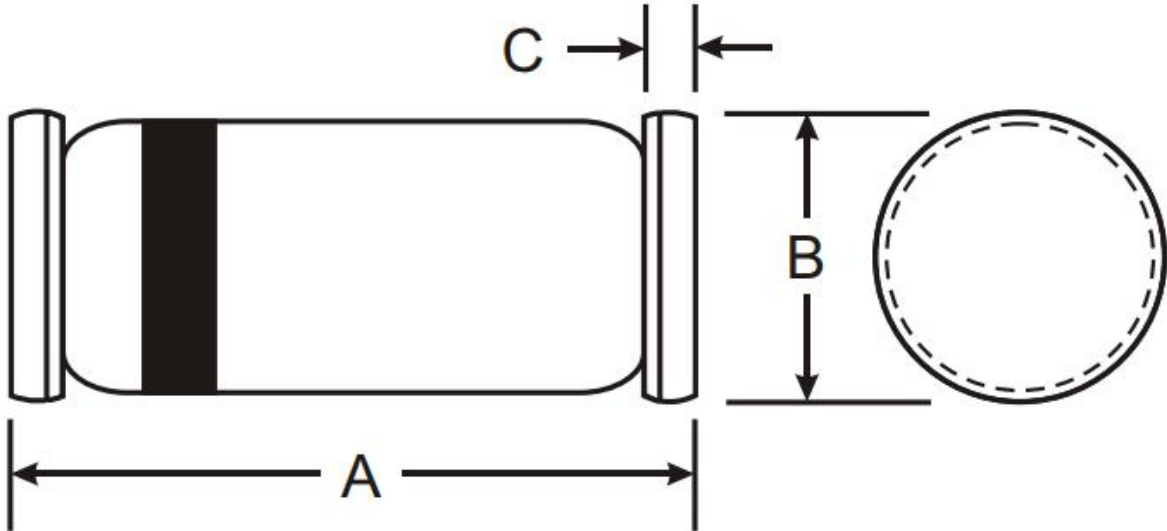

Symbol	Dimensions In Millimeters		Dimensions In Inches	
	Min.	Max.	Min.	Max.
A	3.300	3.700	0.130	0.147
B	1.300	1.600	0.051	0.063
C	0.280	0.500	0.011	0.020

**LL-34 Suggested Pad Layout**

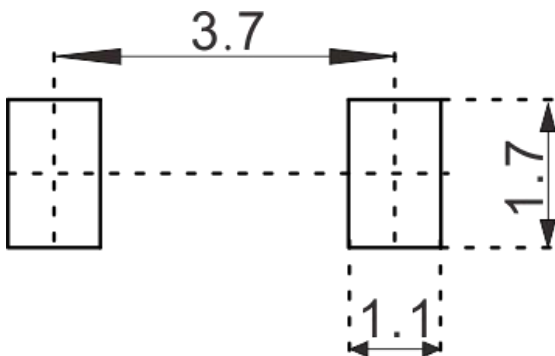

**Note:**

1. Controlling dimension: in millimeters
2. General tolerance:  $\pm 0.05\text{mm}$
3. The pad layout is for reference purposes only

ZENER DIODE

LL-34 Tape and Reel

LL-34 Embossed Carrier Tape

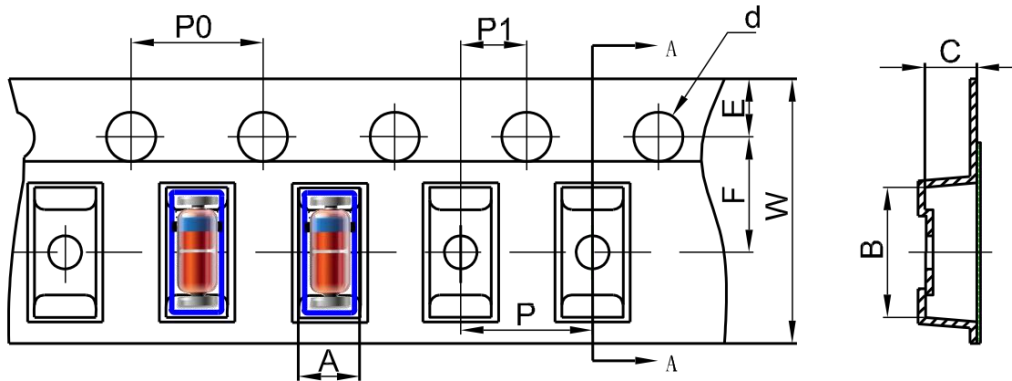

DIMENSIONS ARE IN MILLIMETER										
TYPE	A	B	C	d	E	F	P0	P	P1	W
LL-34	1.60	3.90	1.60	Ø1.50	1.75	3.50	4.00	4.00	2.00	8.00
TOLERANCE	±0.05	±0.05	±0.05	±0.1	±0.1	±0.1	±0.1	±0.1	±0.1	±0.1

LL-34 Tape Leader and Trailer

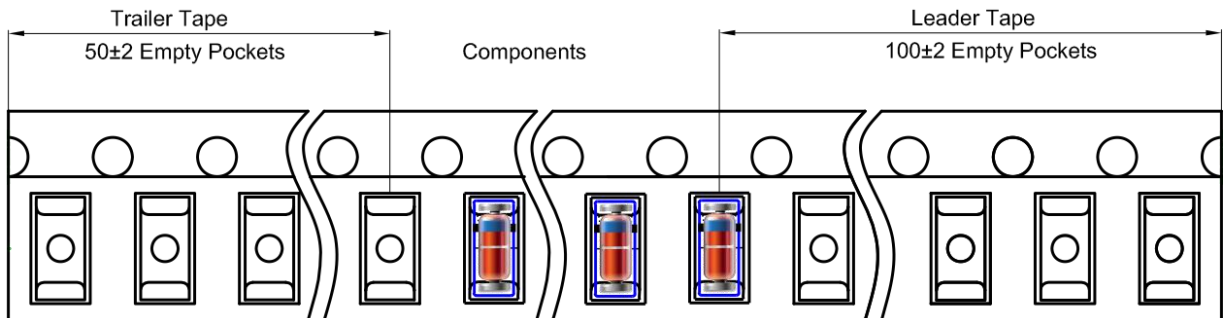

LL-34 Reel

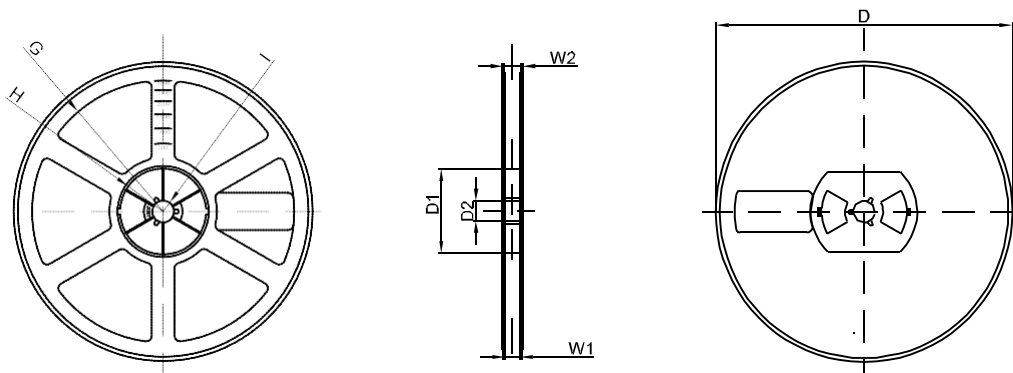

DIMENSIONS ARE IN MILLIMETER								
REEL OPTION	D	D1	D2	G	H	I	W1	W2
7" DIA	Ø178	54.40	13.00	R78	R25.60	R6.50	9.50	12.30
TOLERANCE	±2	±1	±1	±1	±1	±1	±1	±1